



collegebatch.com

click to campus

WBJEE 2024 Question Paper

West Bengal Joint Entrance Examinations

Download more WBJEE Previous Year Question Papers: [Click Here](#)

WBJEE Paper - 2024

Mathematics

Question 1

All values of a for which the inequality $\frac{1}{\sqrt{a}} \int_1^a \left(\frac{3}{2} \sqrt{x} + 1 - \frac{1}{\sqrt{x}} \right) dx < 4$ is satisfied, lie in the interval

Options:

A.

(1, 2)

B.

(0, 3)

C.

(0, 4)

D.

(1, 4)

Answer: C

Question 2

For any integer n , $\int_0^{\pi} e^{\cos^2 x} \cdot \cos^3(2n + 1)x \, dx$ has the value :

Options:

A.

π

B.

1

C.

0

D.

$\frac{3\pi}{2}$

Answer: C

Solution:

To solve the given integral, let's consider the integral:

$$\int_0^\pi e^{\cos^2 x} \cdot \cos^3((2n+1)x) dx$$

First, observe the integrand carefully. It includes the term $\cos^3((2n+1)x)$ which can be expanded using the trigonometric identity for cosine:

$$\cos^3(\theta) = \frac{1}{4}(\cos(3\theta) + 3\cos(\theta))$$

Applying this identity to the integrand, we have:

$$\cos^3((2n+1)x) = \frac{1}{4}(\cos(3(2n+1)x) + 3\cos((2n+1)x))$$

Substitute this back into the integral:

$$\int_0^\pi e^{\cos^2 x} \cdot \frac{1}{4}(\cos(3(2n+1)x) + 3\cos((2n+1)x)) dx$$

This can be broken down into two separate integrals:

$$\frac{1}{4} \int_0^\pi e^{\cos^2 x} \cos(3(2n+1)x) dx + \frac{3}{4} \int_0^\pi e^{\cos^2 x} \cos((2n+1)x) dx$$

Now, consider the properties of definite integrals and the cosine function over the interval from 0 to π . For odd multiples of x , the integral over the symmetric limits will cancel out to zero due to the periodicity and symmetry of the cosine function.

Specifically, for any odd integer k :

$$\int_0^\pi \cos(kx) dx = 0$$

Therefore:

$$\int_0^\pi e^{\cos^2 x} \cos(3(2n+1)x) dx = 0$$

and

$$\int_0^\pi e^{\cos^2 x} \cos((2n+1)x) dx = 0$$

Thus, combining these results:

$$\frac{1}{4} \times 0 + \frac{3}{4} \times 0 = 0$$

Therefore, the value of the integral is:

0

So, the correct option is:

Option C: 0

Question 3

Let f be a differential function with $\lim_{x \rightarrow \infty} f(x) = 0$. If $y' + yf'(x) - f(x)f'(x) = 0$, $\lim_{x \rightarrow \infty} y(x) = 0$ then

Options:

A.

$$y + 1 = e^{f(x)} + f(x)$$

B.

$$y + 1 = e^{-f(x)} + f(x)$$

C.

$$y + 2 = e^{-f(x)} + f(x)$$

D.

$$y - 1 = e^{-f(x)} + f(x)$$

Answer: B

Question 4

If $xy' + y - e^x = 0$, $y(a) = b$, then $\lim_{x \rightarrow 1} y(x)$ is

Options:

A.

$$e + 2ab - e^a$$

B.

$$e^2 + ab - e^{-a}$$

C.

$$e - ab + e^a$$

D.

$$e + ab - e^a, \left(y' = \frac{dy}{dx} \right)$$

Answer: D

Solution:

Let's solve the given differential equation and find the limit $\lim_{x \rightarrow 1} y(x)$.

The differential equation given is:

$$xy' + y - e^x = 0$$

This is a first-order linear differential equation. We can rewrite it in the form:

$$y' + \frac{1}{x}y = \frac{e^x}{x}$$

We will solve this using the integrating factor method. The integrating factor (IF) is given by:

$$\mu(x) = e^{\int \frac{1}{x} dx} = e^{\ln|x|} = |x|$$

Since we are not given a specific interval for x , we assume x is positive:

$$\mu(x) = x$$

Multiplying both sides of the differential equation by the integrating factor:

$$xy' + y = e^x \Rightarrow xy' + y = e^x \Rightarrow x\left(y' + \frac{1}{x}y\right) = e^x$$

$$x \cdot y' + y = e^x$$

Recognize that the left side is the derivative of xy :

$$\frac{d}{dx}(xy) = e^x$$

Integrate both sides with respect to x :

$$xy = \int e^x dx = e^x + C$$

So we have:

$$y = \frac{e^x + C}{x}$$

Apply the initial condition $y(a) = b$:

$$b = \frac{e^a + C}{a}$$

$$C = ab - e^a$$

Thus, the solution to the differential equation is:

$$y = \frac{e^x + ab - e^a}{x}$$

Now, we need to determine:

$$\lim_{x \rightarrow 1} y(x)$$

Substituting $x = 1$ into the solution:

$$y(1) = \frac{e^1 + ab - e^a}{1} = e + ab - e^a$$

Therefore:

The correct answer is Option D

$$e + ab - e^a$$

Question 5

The area bounded by the curves $x = 4 - y^2$ and the Y-axis is

Options:

A.

16 sq. unit

B.

$\frac{32}{3}$ sq. unit

C.

$\frac{16}{3}$ sq. unit

D.

32 sq. unit

Answer: B

Question 6

$f(x) = \cos x - 1 + \frac{x^2}{2!}, x \in \mathbb{R}$ Then $f(x)$ is

Options:

A.

decreasing function

B.

increasing function

C.

neither increasing nor decreasing

D.

constant $\forall x > 0$

Answer: C

Question 7

Let $y = f(x)$ be any curve on the $X - Y$ plane & P be a point on the curve. Let C be a fixed point not on the curve. The length PC is either a maximum or a minimum, then

Options:

A.

PC is perpendicular to the tangent at P

B.

PC is parallel to the tangent at P

C.

PC meets the tangent at an angle of 45°

D.

PC meets the tangent at an angle of 60°

Answer: A

Question 8

If a particle moves in a straight line according to the law $x = a \sin(\sqrt{\lambda}t + b)$, then the particle will come to rest at two points whose distance is [symbols have their usual meaning]

Options:

A.

a

B.

$\frac{a}{2}$

C.

2a

D.

4a

Answer: C

Question 9

A unit vector in XY-plane making an angle 45° with $\hat{i} + \hat{j}$ and an angle 60° with $3\hat{i} - 4\hat{j}$ is

Options:

A.

$$\frac{13}{14}\hat{i} + \frac{1}{14}\hat{j}$$

B.

$$\frac{1}{14}\hat{i} + \frac{13}{14}\hat{j}$$

C.

$$\frac{13}{14}\hat{i} - \frac{1}{14}\hat{j}$$

D.

$$\frac{1}{14}\hat{i} - \frac{13}{14}\hat{j}$$

Answer: A

Solution:

Let's denote the unit vector as $\vec{u} = a\hat{i} + b\hat{j}$, where a and b are the components of the vector along the x and y axes, respectively. According to the given problem, this unit vector makes an angle of 45° with $\hat{i} + \hat{j}$ and an angle of 60° with $3\hat{i} - 4\hat{j}$.

We can start by using the dot product formula to generate necessary equations. The dot product of two vectors \vec{u} and \vec{v} is given by:

$$\vec{u} \cdot \vec{v} = |\vec{u}||\vec{v}| \cos \theta$$

Since \vec{u} is a unit vector, $|\vec{u}| = 1$, and thus the dot product simplifies to:

$$\vec{u} \cdot \vec{v} = |\vec{v}| \cos \theta$$

Let's apply this to both given vectors.

For the first vector, $\hat{i} + \hat{j}$:

Here, $\vec{v}_1 = \hat{i} + \hat{j}$ and the angle is 45° .

The magnitude of \vec{v}_1 is:

$$|\vec{v}_1| = \sqrt{1^2 + 1^2} = \sqrt{2}$$

The equation becomes:

$$\vec{u} \cdot (\hat{i} + \hat{j}) = \sqrt{2} \cos 45^\circ$$

$$a + b = \sqrt{2} \cdot \frac{1}{\sqrt{2}}$$

$$a + b = 1$$

For the second vector, $3\hat{i} - 4\hat{j}$:

Here, $\vec{v}_2 = 3\hat{i} - 4\hat{j}$ and the angle is 60° .

The magnitude of \vec{v}_2 is:

$$|\vec{v}_2| = \sqrt{3^2 + (-4)^2} = \sqrt{9 + 16} = \sqrt{25} = 5$$

The equation becomes:

$$\vec{u} \cdot (3\hat{i} - 4\hat{j}) = 5 \cos 60^\circ$$

$$3a - 4b = 5 \cdot \frac{1}{2}$$

$$3a - 4b = \frac{5}{2}$$

Now we have a system of two equations:

$$a + b = 1$$

$$3a - 4b = \frac{5}{2}$$

We can solve this system of equations to find the values of a and b .

From the first equation, solve for b :

$$b = 1 - a$$

Substitute this into the second equation:

$$3a - 4(1 - a) = \frac{5}{2}$$

$$3a - 4 + 4a = \frac{5}{2}$$

$$7a - 4 = \frac{5}{2}$$

$$7a = \frac{5}{2} + 4$$

$$7a = \frac{5}{2} + \frac{8}{2}$$

$$7a = \frac{13}{2}$$

$$a = \frac{13}{14}$$

Substitute back to find b :

$$b = 1 - \frac{13}{14}$$

$$b = \frac{14}{14} - \frac{13}{14}$$

$$b = \frac{1}{14}$$

Thus, the unit vector is:

$$\vec{u} = \frac{13}{14}\hat{i} + \frac{1}{14}\hat{j}$$

Therefore, the correct option is:

Option A: $\frac{13}{14}\hat{i} + \frac{1}{14}\hat{j}$

But $|\vec{u}| = \sqrt{\left(\frac{13}{14}\right)^2 + \left(\frac{1}{14}\right)^2} \neq 1$. So, \vec{u} is not a unit vector.

Question 10

Let $f : \mathbb{R} \rightarrow \mathbb{R}$ be given by $f(x) = x^2 - 1$, then

Options:

A.

f has a local minima at $x = \pm 1$ but no local maxima

B.

f has a local maxima at $x = 0$, but no local minima

C.

f has a local minima at $x = \pm 1$ and a local maxima at $x = 0$

D.

f has neither any local maxima nor any local minima

Answer: C

Question 11

Given an A.P. and a G.P. with positive terms, with the first and second terms of the progressions being equal. If a_n and b_n be the n^{th} term of A.P. and G.P. respectively then

Options:

A.

$a_n > b_n$ for all $n > 2$

B.

$a_n < b_n$ for all $n > 2$

C.

$a_n = b_n$ for some $n > 2$

D.

$a_n = b_n$ for some odd n

Answer: B

Question 12

If for the series a_1, a_2, a_3, \dots etc, $a_r - a_{r+i}$ bears a constant ratio with $a_r \cdot a_{r+1}$; then $a_1, a_2, a_3 \dots$ are in

Options:

A.

A.P.

B.

G.P.

C.

H.P.

D.

Any other series

Answer: C

Question 13

If z_1 and z_2 be two roots of the equation $z^2 + az + b = 0, a^2 < 4b$, then the origin, z_1 and z_2 form an equilateral triangle if

Options:

A.

$$a^2 = 3b^2$$

B.

$$a^2 = 3b$$

C.

$$b^2 = 3a$$

D.

$$b^2 = 3a^2$$

Answer: B

Question 14

If $\cos \theta + i \sin \theta$, $\theta \in \mathbb{R}$, is a root of the equation

$$a_0 x^n + a_1 x^{n-1} + \dots + a_{n-1} x + a_n = 0, a_0, a_1, \dots, a_n \in \mathbb{R}, a_0 \neq 0,$$

then the value of $a_1 \sin \theta + a_2 \sin 2\theta + \dots + a_n \sin n\theta$ is

Options:

A.

$$2n$$

B.

$$n$$

C.

$$0$$

D.

$$n + 1$$

Answer: C

Question 15

If $(x^2 \log_x 27) \cdot \log_9 x = x + 4$ then the value of x is

Options:

A.

2

B.

$-\frac{4}{3}$

C.

-2

D.

$\frac{4}{3}$

Answer: A

Question 16

If $P(x) = ax^2 + bx + c$ and $Q(x) = -ax^2 + dx + c$ where $ac \neq 0$, then $P(x) \cdot Q(x) = 0$ has (a, b, c, d are real)

Options:

A.

2 real roots

B.

at least two real roots

C.

4 real roots

D.

no real root

Answer: B

Question 17

Let N be the number of quadratic equations with coefficients from $\{0, 1, 2, \dots, 9\}$ such that 0 is a solution of each equation. Then the value of N is

Options:

A.

2^9

B.

3^9

C.

90

D.

81

Answer: C

Question 18

If a, b, c are distinct odd natural numbers, then the number of rational roots of the equation $ax^2 + bx + c = 0$

Options:

A.

must be 0

B.

must be 1

C.

must be 2

D.

cannot be determined from the given data

Answer: A

Question 19

The numbers $1, 2, 3, \dots, m$ are arranged in random order. The number of ways this can be done, so that the numbers $1, 2, \dots, r$ ($r < m$) appears as neighbours is

Options:

A.

$$(m - r) !$$

B.

$$(m - r + 1) !$$

C.

$$(m - r)!r !$$

D.

$$(m - r + 1)!r !$$

Answer: D

Question 20

If $A = \begin{pmatrix} \cos \theta & -\sin \theta \\ \sin \theta & \cos \theta \end{pmatrix}$ and $\theta = \frac{2\pi}{7}$, then $A^{100} = A \times A \times \dots$ (100 times) is equal to

Options:

A.

$$\begin{pmatrix} \cos 2\theta & -\sin 2\theta \\ \sin 2\theta & \cos 2\theta \end{pmatrix}$$

B.

$$\begin{pmatrix} \cos \theta & -\sin \theta \\ \sin \theta & \cos \theta \end{pmatrix}$$

C.

$$\begin{pmatrix} 1 & 0 \\ 0 & 1 \end{pmatrix}$$

D.

$$\begin{pmatrix} 0 & -1 \\ 1 & 0 \end{pmatrix}$$

Answer: A

Question 21

If $(1 + x + x^2 + x^3)^5 = \sum_{k=0}^{15} a_k x^k$ then $\sum_{k=0}^7 (-1)^k \cdot a_{2k}$ is equal to

Options:

A.

$$2^5$$

B.

$$4^5$$

C.

$$0$$

D.

$$4^4$$

Answer: C

Question 22

The coefficient of $a^{10}b^7c^3$ in the expansion of $(bc + ca + ab)^{10}$ is

Options:

A.

$$140$$

B.

$$150$$

C.

D.

Answer: C**Question 23**

$$\text{If } \begin{array}{ccc} x^k & x^{k+2} & x^{k+3} \\ y^k & y^{k+2} & y^{k+3} \\ z^k & z^{k+2} & z^{k+3} \end{array} = (x - y)(y - z)(z - x) \left(\frac{1}{x} + \frac{1}{y} + \frac{1}{z} \right), \text{ then}$$

Options:

A.

$k = -3$

B.

$k = 3$

C.

$k = 1$

D.

$k = -1$

Answer: D**Question 24**

$$\text{If } \begin{bmatrix} 2 & 1 \\ 3 & 2 \end{bmatrix} \cdot A \cdot \begin{bmatrix} -3 & 2 \\ 5 & -3 \end{bmatrix} = \begin{bmatrix} 1 & 0 \\ 0 & 1 \end{bmatrix}, \text{ then } A =$$

Options:

A.

$$\begin{bmatrix} 1 & 1 \\ 1 & 0 \end{bmatrix}$$

B.

$$\begin{bmatrix} 1 & 1 \\ 0 & 1 \end{bmatrix}$$

C.

$$\begin{bmatrix} 1 & 0 \\ 1 & 1 \end{bmatrix}$$

D.

$$\begin{bmatrix} 0 & 1 \\ 1 & 1 \end{bmatrix}$$

Answer: A

Question 25

$$\text{Let } f(x) = \begin{matrix} \cos x & x & 1 \\ 2 \sin x & x^3 & 2x \\ \tan x & x & 1 \end{matrix}, \text{ then } \lim_{x \rightarrow 0} \frac{f(x)}{x^2} =$$

Options:

A.

2

B.

-2

C.

1

D.

-1

Answer: B

Question 26

**In \mathbb{R} , a relation p is defined as follows: $\forall a, b \in \mathbb{R}, ap$ holds iff $a^2 - 4ab + 3b^2 = 0$.
Then**

Options:

A.

p is equivalence relation

B.

p is only symmetric

C.

p is only reflexive

D.

p is only transitive

Answer: C

Question 27

Let $f : \mathbb{R} \rightarrow \mathbb{R}$ be a function defined by $f(x) = \frac{e^{|x|} - e^{-x}}{e^x + e^{-x}}$, then

Options:

A.

f is both one-one and onto

B.

f is one-one but not onto

C.

f is onto but not one-one

D.

f is neither one-one nor onto

Answer: D

Question 28

Let A be the set of even natural numbers that are < 8 & B be the set of prime integers that are < 7 The number of relations from A to B are

Options:

A.

$$3^2$$

B.

$$2^{9-1}$$

C.

$$9^2$$

D.

$$2^9$$

Answer: D

Question 29

Two smallest squares are chosen one by one on a chess board. The probability that they have a side in common is

Options:

A.

$$\frac{1}{9}$$

B.

$$\frac{2}{7}$$

C.

$$\frac{1}{18}$$

D.

$$\frac{5}{18}$$

Answer: C

Question 30

Two integers r and s are drawn one at a time without replacement from the set $\{1, 2, \dots, n\}$. Then $P(r \leq k/s \leq k) =$

(k is an integer $< n$)

Options:

A.

$$\frac{k}{n}$$

B.

$$\frac{k}{n-1}$$

C.

$$\frac{k-1}{n}$$

D.

$$\frac{k-1}{n-1}$$

Answer: D

Question 31

A biased coin with probability p ($0 < p < 1$) of getting head is tossed until a head appears for the first time. If the probability that the number of tosses required is even is $\frac{2}{5}$, then $p =$

Options:

A.

$$\frac{1}{4}$$

B.

$$\frac{1}{3}$$

C.

$$\frac{2}{3}$$

D.

$$\frac{3}{4}$$

Answer: B

Question 32

The expression $\cos^2 \phi + \cos^2(\theta + \phi) - 2 \cos \theta \cos \phi \cos(\theta + \phi)$ is

Options:

A.

independent of θ

B.

independent of ϕ

C.

independent of θ and ϕ

D.

dependent on θ and ϕ

Answer: B

Solution:

To determine whether the expression $\cos^2 \phi + \cos^2(\theta + \phi) - 2 \cos \theta \cos \phi \cos(\theta + \phi)$ depends on θ and ϕ , we need to simplify it and check for any dependencies on these variables.

Let's rewrite the expression:

$$\cos^2 \phi + \cos^2(\theta + \phi) - 2 \cos \theta \cos \phi \cos(\theta + \phi)$$

Consider the trigonometric identity for cosine of a sum:

$$\cos(\theta + \phi) = \cos \theta \cos \phi - \sin \theta \sin \phi$$

However, using this identity directly seems cumbersome. Instead, let's look at another potential approach, focusing on the structure of the expression. Notice that it is a combination of squared cosines and a product of cosines. If we consider transforming the expression into terms of squares and products, we might be able to discern its dependencies more easily.

Rewriting the expression in another form to recognize a potential independence can help. Let us test whether it can be simplified to a more recognizable form. After considerable algebraic manipulation, you would find it simplifies to:

$$\cos^2 \phi + \cos^2(\theta + \phi) - 2 \cos \theta \cos \phi \cos(\theta + \phi) = \sin^2 \theta$$

Thus, the given expression simplifies to:

$$\sin^2 \theta$$

From this result, it's clear that the simplified expression only depends on θ .

Hence, the correct option is:

Option B: independent of ϕ

Question 33

If $0 < \theta < \frac{\pi}{2}$ and $\tan 3\theta \neq 0$, then $\tan \theta + \tan 2\theta + \tan 3\theta = 0$ if $\tan \theta \cdot \tan 2\theta = k$ where $k =$

Options:

A.

1

B.

2

C.

3

D.

4

Answer: B

Question 34

The equation $r \cos \theta = 2a \sin^2 \theta$ represents the curve

Options:

A.

$$x^3 = y^2(2a + x)$$

B.

$$x^2 = y^2(2a + x)$$

C.

$$x^3 = y^2(2a - x)$$

D.

$$x^3 = y^2(a + x)$$

Answer: C

Question 35

If $(1, 5)$ be the midpoint of the segment of a line between the line $5x - y - 4 = 0$ and $3x + 4y - 4 = 0$, then the equation of the line will be

Options:

A.

$$83x + 35y - 92 = 0$$

B.

$$83x - 35y + 92 = 0$$

C.

$$83x - 35y - 92 = 0$$

D.

$$83x + 35y + 92 = 0$$

Answer: B

Question 36

In $\triangle ABC$, co-ordinates of A are $(1, 2)$ and the equation of the medians through B and C are $x + y = 5$ and $x = 4$ respectively. Then the midpoint of BC is

Options:

A.

$$\left(5, \frac{1}{2}\right)$$

B.

$$\left(\frac{11}{2}, 1\right)$$

C.

$$\left(11, \frac{1}{2}\right)$$

D.

$$\left(\frac{11}{2}, \frac{1}{2}\right)$$

Answer: D

Question 37

A line of fixed length $a + b$. $a \neq b$ moves so that its ends are always on two fixed perpendicular straight lines. The locus of a point which divides the line into two parts of length a and b is

Options:

A.

a parabola

B.

a circle

C.

an ellipse

D.

a hyperbola

Answer: C

Question 38

With origin as a focus and $x = 4$ as corresponding directrix, a family of ellipse are drawn. Then the locus of an end of minor axis is

Options:

A.

a circle

B.

a parabola

C.

a straight line

D.

a hyperbola

Answer: B

Question 39

Chords AB & CD of a circle intersect at right angle at the point P. If the length of AP, PB, CP, PD are 2, 6, 3, 4 units respectively, then the radius of the circle is

Options:

A.

4 units

B.

$\frac{\sqrt{65}}{2}$ units

C.

$\frac{\sqrt{67}}{2}$ units

D.

$\frac{\sqrt{66}}{2}$ units

Answer: B

Question 40

The plane $2x - y + 3z + 5 = 0$ is rotated through 90° about its line of intersection with the plane $x + y + z = 1$. The equation of the plane in new position is

Options:

A.

$3x + 9y + z + 17 = 0$

B.

$3x + 9y + z = 17$

C.

$$3x - 9y - z = 17$$

D.

$$3x + 9y - z = 17$$

Answer: B

Question 41

If the relation between the direction ratios of two lines in \mathbb{R}^3 are given by

$$l + m + n = 0, 2l m + 2mn - ln = 0$$

then the angle between the lines is (l, m, n have their usual meaning)

Options:

A.

$$\frac{\pi}{6}$$

B.

$$\frac{2\pi}{3}$$

C.

$$\frac{\pi}{2}$$

D.

$$\frac{\pi}{4}$$

Answer: B

Question 42

$\triangle OAB$ is an equilateral triangle inscribed in the parabola $y^2 = 4ax, a > 0$ with O as the vertex, then the length of the side of $\triangle OAB$ is

Options:

A.

$8a\sqrt{3}$ unit

B.

$8a$ unit

C.

$4a\sqrt{3}$ unit

D.

$4a$ unit

Answer: A

Question 43

For every real number $x \neq -1$, let $f(x) = \frac{x}{x+1}$. Write $f_1(x) = f(x)$ & for $n \geq 2$, $f_n(x) = f(f_{n-1}(x))$. Then $f_1(-2) \cdot f_2(-2) \cdot \dots \cdot f_n(-2)$ must be

Options:

A.

$$\frac{2^n}{1.3.5 \dots (2n-1)}$$

B.

1

C.

$$\frac{1}{2} \binom{2n}{n}$$

D.

$$\binom{2n}{n}$$

Answer: A

Question 44

If U_n ($n = 1, 2$) denotes the n^{th} derivative ($n = 1, 2$) of $U(x) = \frac{Lx+M}{x^2-2Bx+C}$ (L, M, B, C are constants), then $PU_2 + QU_1 + RU = 0$, holds for

Options:

A.

$$P = x^2 - 2B, Q = 2x, R = 3x$$

B.

$$P = x^2 - 2Bx + C, Q = 4(x - B), R = 2$$

C.

$$P = 2x, Q = 2B, R = 2$$

D.

$$P = x^2, Q = x, R = 3$$

Answer: B

Question 45

The equation $2^x + 5^x = 3^x + 4^x$ has

Options:

A.

no real solution

B.

only one non-zero real solution

C.

infinitely many solutions

D.

only three non-negative real solutions

Answer: B

Question 46

Consider the function $f(x) = (x - 2) \log_e x$. Then the equation $x \log_e x = 2 - x$

Options:

A.

has at least one root in $(1, 2)$

B.

has no root in $(1, 2)$

C.

is not at all solvable

D.

has infinitely many roots in $(-2, 1)$

Answer: A

Question 47

If α, β are the roots of the equation $ax^2 + bx + c = 0$ then $\lim_{x \rightarrow \beta} \frac{1 - \cos(ax^2 + bx + c)}{(x - \beta)^2}$ is

Options:

A.

$$(\alpha - \beta)^2$$

B.

$$\frac{1}{2}(\alpha - \beta)^2$$

C.

$$\frac{a^2}{4}(\alpha - \beta)^2$$

D.

$$\frac{a^2}{2}(\alpha - \beta)^2$$

Answer: D

Question 48

If $f(x) = \frac{e^x}{1+e^x}$, $I_1 = \int_{f(-a)}^{f(a)} x g(x(1-x)) dx$ and $I_2 = \int_{f(-a)}^{f(a)} g(x(1-x)) dx$, then the value of $\frac{I_2}{I_1}$ is

Options:

A.

-1

B.

-3

C.

2

D.

1

Answer: C

Question 49

Let $f : \mathbb{R} \rightarrow \mathbb{R}$ be a differentiable function and $f(1) = 4$. Then the value of

$\lim_{x \rightarrow 1} \int_4^{f(x)} \frac{2t}{x-1} dt$, if $f'(1) = 2$ is

Options:

A.

16

B.

8

C.

4

D.

2

Answer: A

Question 50

If $\int \frac{\log_e(x + \sqrt{1+x^2})}{\sqrt{1+x^2}} dx = f(g(x)) + c$ then

Options:

A.

$$f(x) = \frac{x^2}{2}, g(x) = \log_e(x + \sqrt{1+x^2})$$

B.

$$f(x) = \log_e(x + \sqrt{1+x^2}), g(x) = \frac{x^2}{2}$$

C.

$$f(x) = x^2, g(x) = \log_e(x + \sqrt{1+x^2})$$

D.

$$f(x) = \log_e(x - \sqrt{1+x^2}), g(x) = x^2$$

Answer: A

Question 51

Let $I(R) = \int_0^R e^{-R \sin x} dx, R > 0$. then,

Options:

A.

$$I(R) > \frac{\pi}{2R}(1 - e^{-R})$$

B.

$$I(R) < \frac{\pi}{2R}(1 - e^{-R})$$

C.

$$I(R) = \frac{\pi}{2R}(1 - e^{-R})$$

D.

$I(R)$ and $\frac{\pi}{2R}(1 - e^{-R})$ are not comparable

Answer: D

Question 52

Consider the function $f(x) = x(x - 1)(x - 2) \dots (x - 100)$. Which one of the following is correct?

Options:

A.

This function has 100 local maxima

B.

This function has 50 local maxima

C.

This function has 51 local maxima

D.

Local minima do not exist for this function

Answer: B

Question 53

In a plane \vec{a} and \vec{b} are the position vectors of two points A and B respectively. A point P with position vector \vec{r} moves on that plane in such a way that $|\vec{r} - \vec{a}| \sim |\vec{r} - \vec{b}| = c$ (real constant). The locus of P is a conic section whose eccentricity is

Options:

A.

$$\frac{|\vec{a} - \vec{b}|}{c}$$

B.

$$\frac{|\vec{a}+\vec{b}|}{c}$$

C.

$$\frac{|\vec{a}-\vec{b}|}{2c}$$

D.

$$\frac{|\vec{a}+\vec{b}|}{2c}$$

Answer: A

Question 54

Five balls of different colours are to be placed in three boxes of different sizes. The number of ways in which we can place the balls in the boxes so that no box remains empty is

Options:

A.

160

B.

140

C.

180

D.

150

Answer: D

Solution:

Let's denote the five balls by A, B, C, D, E and the three different boxes by X, Y, Z . We need to place these five balls into the three boxes such that no box remains empty.

First, let's calculate the total number of ways to distribute 5 balls into 3 boxes without any restriction. Since each of the 5 balls can be placed in any of the 3 boxes, the number of unrestricted distributions is:

$$3^5 = 243$$

Now, we need to subtract the cases where one or more boxes are empty. We'll use the principle of inclusion-exclusion to account for these cases.

Step 1: Subtract the cases where one box is empty

If one box is empty, we need to distribute the balls into the remaining two boxes. There are:

$$2^5 = 32$$

ways to distribute the 5 balls into the 2 remaining boxes. Since there are 3 boxes and any one of them can be empty, we need to multiply by 3:

$$3 \times 32 = 96$$

Step 2: Add back the cases where two boxes are empty

If two boxes are empty, all the balls must go into the remaining one box. There is only 1 way to do this, and since we can choose which single box is non-empty in 3 ways, we need to add back:

$$3 \times 1 = 3$$

By applying the principle of inclusion-exclusion, the number of distributions where no box is empty is:

$$243 - 96 + 3 = 150$$

Thus, the number of ways to place the five different-colored balls in three different boxes such that no box remains empty is:

Option D: 150

Question 55

$$\text{Let } A = \begin{pmatrix} 1 & -1 & 0 \\ 0 & 1 & -1 \\ 1 & 1 & 1 \end{pmatrix}, B = \begin{pmatrix} 2 \\ 1 \\ 7 \end{pmatrix}$$

Then for the validity of the result $AX = B$, X is

Options:

A.

$$\begin{pmatrix} -1 \\ 1 \\ 7 \end{pmatrix}$$

B.

$$\begin{pmatrix} 1 \\ 2 \\ 4 \end{pmatrix}$$

C.

$$\begin{pmatrix} 3 \\ 1 \\ -1 \end{pmatrix}$$

D.

$$\begin{pmatrix} 4 \\ 2 \\ 1 \end{pmatrix}$$

Answer: D

Question 56

If $\alpha_1, \alpha_2, \dots, \alpha_n$ are in A.P. with common difference θ , then the sum of the series $\sec \alpha_1 \sec \alpha_2 + \sec \alpha_2 \sec \alpha_3 + \dots + \sec \alpha_{n-1} \sec \alpha_n = k (\tan \alpha_n - \tan \alpha_1)$ where $k =$

Options:

A.

$$\sin \theta$$

B.

$$\cos \theta$$

C.

$$\sec \theta$$

D.

$$\operatorname{cosec} \theta$$

Answer: D

Solution:

$$\alpha_2 - \alpha_1 = \alpha_3 - \alpha_2 = \dots = \alpha_n - \alpha_{n-1} = \theta$$

$$\sec \alpha_1 \sec \alpha_2 + \sec \alpha_2 \sec \alpha_3 + \dots + \sec \alpha_{n-1} \sec \alpha_n$$

$$\begin{aligned} &= \frac{1}{\cos \alpha_1 \cos \alpha_2} + \frac{1}{\cos \alpha_2 \cos \alpha_3} + \dots + \frac{1}{\cos \alpha_{n-1} \cos \alpha_n} \\ &= \frac{1}{\sin \theta} \left[\frac{\sin \theta}{\cos \alpha_1 \cos \alpha_2} + \frac{\sin \theta}{\cos \alpha_2 \cos \alpha_3} + \dots + \frac{\sin \theta}{\cos \alpha_{n-1} \cos \alpha_n} \right] \\ &= \frac{1}{\sin \theta} \left[\frac{\sin (\alpha_2 - \alpha_1)}{\cos \alpha_1 \cos \alpha_2} + \frac{\sin (\alpha_3 - \alpha_2)}{\cos \alpha_2 \cos \alpha_3} + \dots + \frac{\sin (\alpha_n - \alpha_{n-1})}{\cos \alpha_{n-1} \cos \alpha_n} \right] \\ &= \frac{1}{\sin \theta} [(\tan \alpha_2 - \tan \alpha_1) + (\tan \alpha_3 - \tan \alpha_2) + \dots + (\tan \alpha_n - \tan \alpha_{n-1})] \\ &= \frac{1}{\sin \theta} [\tan \alpha_n - \tan \alpha_1] = \operatorname{cosec} \theta (\tan \alpha_n - \tan \alpha_1) \\ &= k (\tan \alpha_n - \tan \alpha_1) \end{aligned}$$

Comparing we get

$$k = \operatorname{cosec} \theta$$

Question 57

For the real numbers x & y , we write x p y iff $x - y + \sqrt{2}$ is an irrational number. Then relation p is

Options:

A.

reflexive

B.

symmetric

C.

transitive

D.

equivalence relation

Answer: A

Solution:

To analyze the relation p given by $x p y$ iff $x - y + \sqrt{2}$ is an irrational number, let's evaluate whether the relation is reflexive, symmetric, transitive, or an equivalence relation.

Reflexive :

A relation is reflexive if every element is related to itself. For $x p x$ to hold, we need $x - x + \sqrt{2}$ to be irrational. Simplifying, $x - x = 0$, and $0 + \sqrt{2} = \sqrt{2}$, which is indeed irrational. Therefore, the relation p is reflexive.

Reflexive: **Yes**

Symmetric :

Consider $(\sqrt{2}, 1) \in p \Rightarrow \sqrt{2} - 1 + \sqrt{2} = 2\sqrt{2} - 1$ is irrational number.

but $(1, \sqrt{2}) \notin p$ as $1 - \sqrt{2} + \sqrt{2} = 1$ is not an irrational number.

Thus p is not symmetric.

Symmetric : **No**

Transitive :

$(\sqrt{2}, 1) \in p$ as $\sqrt{2} - 1 + \sqrt{2}$ is irrational.

$(1, 2\sqrt{2}) \in p$ as $1 - 2\sqrt{2} + \sqrt{2} = 1 - \sqrt{2}$ is irrational.

Now $\sqrt{2} - 2\sqrt{2} + \sqrt{2} = 0$ is not irrational.

$\Rightarrow (\sqrt{2}, 2\sqrt{2}) \notin p$

$\Rightarrow p$ is not transitive relation.

Transitive : **No**

Equivalence Relation :

A relation is an equivalence relation if it is reflexive, symmetric, and transitive. We've established that the relation p is reflexive but not symmetric not transitive. Therefore, the relation p is **not** an equivalence relation.

Equivalence Relation : **No**

Thus, the correct answer is :

Option A : Reflexive

Question 58

Let $A = \begin{bmatrix} 0 & 0 & -1 \\ 0 & -1 & 0 \\ -1 & 0 & 0 \end{bmatrix}$, then

Options:

A.

A is a null matrix

B.

A is skew symmetric matrix

C.

A^{-1} does not exist

D.

$A^2 = I$

Answer: D

Solution:

To determine the correct option, let's analyze the given matrix A :

$$A = \begin{bmatrix} 0 & 0 & -1 \\ 0 & -1 & 0 \\ -1 & 0 & 0 \end{bmatrix}$$

First, let's check if A is a null matrix.

A null matrix is a matrix in which all entries are zero. Clearly, the given matrix A is not a null matrix because it contains nonzero elements (e.g. -1 in positions $A_{1,3}$ and $A_{3,1}$).

So, Option A is incorrect.

Option B: A is a skew-symmetric matrix

A matrix is skew-symmetric if it satisfies the condition $A^T = -A$, where A^T denotes the transpose of matrix A .

Let's compute the transpose of A :

$$A^T = \begin{bmatrix} 0 & 0 & -1 \\ 0 & -1 & 0 \\ -1 & 0 & 0 \end{bmatrix}^T = \begin{bmatrix} 0 & 0 & -1 \\ 0 & -1 & 0 \\ -1 & 0 & 0 \end{bmatrix}$$

Now, let's compute $-A$:

$$-A = \begin{bmatrix} 0 & 0 & 1 \\ 0 & 1 & 0 \\ 1 & 0 & 0 \end{bmatrix}$$

We see that $A^T \neq -A$, hence A is not a skew-symmetric matrix.

Therefore, Option B is incorrect.

Next, let's check if A^{-1} exists.

To check the invertibility of a matrix, we can compute its determinant. If the determinant is non-zero, the matrix is invertible; otherwise, it is not invertible.

We compute the determinant of A as follows:

$$\det(A) = \begin{vmatrix} 0 & 0 & -1 \\ 0 & -1 & 0 \\ -1 & 0 & 0 \end{vmatrix} = 0(0 \cdot 0 - 0 \cdot -1) - 0(0 \cdot 0 - -1 \cdot -1) + (-1)(0 \cdot 0 - (-1) \cdot -1) = -1 \cdot (-1) = -1$$

Since the determinant is non-zero, matrix A is invertible, and A^{-1} exists.

So, Option C is incorrect.

Finally, let's check if $A^2 = I$, where I is the identity matrix.

We compute A^2 as follows:

$$A^2 = A \cdot A = \begin{bmatrix} 0 & 0 & -1 \\ 0 & -1 & 0 \\ -1 & 0 & 0 \end{bmatrix} \cdot \begin{bmatrix} 0 & 0 & -1 \\ 0 & -1 & 0 \\ -1 & 0 & 0 \end{bmatrix} = \begin{bmatrix} 1 & 0 & 0 \\ 0 & 1 & 0 \\ 0 & 0 & 1 \end{bmatrix} = I$$

Thus, $A^2 = I$.

Therefore, Option D is correct.

In conclusion, the correct answer is:

Option D: $A^2 = I$

Question 59

If $1000! = 3^n \times m$ where m is an integer not divisible by 3, then $n =$

Options:

A.

498

B.

298

C.

398

D.

98

Answer: A

Solution:

To find the value of n in the expression $1000! = 3^n \times m$ where m is an integer not divisible by 3, we need to determine the largest power of 3 that divides $1000!$. This can be accomplished by using Legendre's formula, which is also known as de Polignac's formula. The formula is used to determine the exponent of a prime number p in the factorization of $n!$.

Legendre's formula is given by:

$$e_p(n!) = \left\lfloor \frac{n}{p} \right\rfloor + \left\lfloor \frac{n}{p^2} \right\rfloor + \left\lfloor \frac{n}{p^3} \right\rfloor + \left\lfloor \frac{n}{p^4} \right\rfloor + \dots$$

where $\lfloor x \rfloor$ represents the floor function, which gives the greatest integer less than or equal to x , and p is the prime number we are interested in (in this case, 3).

We need to find:

$$e_3(1000!) = \left\lfloor \frac{1000}{3} \right\rfloor + \left\lfloor \frac{1000}{3^2} \right\rfloor + \left\lfloor \frac{1000}{3^3} \right\rfloor + \left\lfloor \frac{1000}{3^4} \right\rfloor + \dots$$

Let's calculate each term step by step:

$$\left\lfloor \frac{1000}{3} \right\rfloor = \lfloor 333.3333 \rfloor = 333$$

$$\left\lfloor \frac{1000}{9} \right\rfloor = \lfloor 111.1111 \rfloor = 111$$

$$\left\lfloor \frac{1000}{27} \right\rfloor = \lfloor 37.037 \rfloor = 37$$

$$\left\lfloor \frac{1000}{81} \right\rfloor = \lfloor 12.3457 \rfloor = 12$$

$$\left\lfloor \frac{1000}{243} \right\rfloor = \lfloor 4.115 \rfloor = 4$$

$$\left\lfloor \frac{1000}{729} \right\rfloor = \lfloor 1.371 \rfloor = 1$$

For powers higher than 3^6 , the terms will be zero since 1000 divided by any higher powers of 3 will be less than 1.

Summing these values, we get:

$$e_3(1000!) = 333 + 111 + 37 + 12 + 4 + 1 = 498$$

Therefore, the value of n is:

$n = 498$

The correct option is:

Option A

Question 60

If A and B are acute angles such that $\sin A = \sin^2 B$ and $2 \cos^2 A = 3 \cos^2 B$, then $(A, B) =$

Options:

A.

$$\left(\frac{\pi}{6}, \frac{\pi}{4}\right)$$

B.

$$\left(\frac{\pi}{6}, \frac{\pi}{6}\right)$$

C.

$$\left(\frac{\pi}{4}, \frac{\pi}{6}\right)$$

D.

$$\left(\frac{\pi}{4}, \frac{\pi}{4}\right)$$

Answer: A

Question 61

If two circles which pass through the points $(0, a)$ and $(0, -a)$ and touch the line $y = mx + c$, cut orthogonally then

Options:

A.

$$c^2 = a^2 (1 + m^2)$$

B.

$$c^2 = a^2 (2 + m^2)$$

C.

$$c^2 = a^2 (1 + 2m^2)$$

D.

$$2c^2 = a^2 (1 + m^2)$$

Answer: B

Question 62

The locus of the midpoint of the system of parallel chords parallel to the line $y = 2x$ to the hyperbola $9x^2 - 4y^2 = 36$ is

Options:

A.

$$8x - 9y = 0$$

B.

$$9x - 8y = 0$$

C.

$$8x + 9y = 0$$

D.

$$9x - 4y = 0$$

Answer: B

Question 63

Angle between two diagonals of a cube will be

Options:

A.

$$\cos^{-1} \left(\frac{1}{3} \right)$$

B.

$$\sin^{-1}\left(\frac{1}{3}\right)$$

C.

$$\frac{\pi}{2} - \cos^{-1}\left(\frac{1}{3}\right)$$

D.

$$\frac{\pi}{2} - \sin^{-1}\left(\frac{1}{3}\right)$$

Answer: A

Solution:

The diagonals of a cube meet at the center of the cube. To determine the angle between two diagonals, consider the geometric properties of the cube.

A cube has 12 face diagonals and 4 space diagonals. We are interested in the space diagonals because they span from one vertex of the cube to the opposite vertex.

Let's place the cube in a 3-dimensional Cartesian coordinate system with vertices at:

$(0,0,0)$, $(1,0,0)$, $(1,1,0)$, $(0,1,0)$, $(0,0,1)$, $(1,0,1)$, $(1,1,1)$, and $(0,1,1)$.

Consider the space diagonals of the cube, such as the one joining $(0,0,0)$ to $(1,1,1)$ and another joining $(1,0,0)$ to $(0,1,1)$. The direction vectors of these diagonals can be written as:

$$\vec{d}_1 = \langle 1, 1, 1 \rangle$$

$$\vec{d}_2 = \langle -1, 1, 1 \rangle$$

We use the dot product formula for vectors to find the angle between them, θ , which is given by:

$$\vec{d}_1 \cdot \vec{d}_2 = |\vec{d}_1||\vec{d}_2| \cos \theta$$

The dot product of these vectors is:

$$\vec{d}_1 \cdot \vec{d}_2 = (1)(-1) + (1)(1) + (1)(1) = -1 + 1 + 1 = 1$$

The magnitudes of the vectors are:

$$|\vec{d}_1| = \sqrt{1^2 + 1^2 + 1^2} = \sqrt{3}$$

$$|\vec{d}_2| = \sqrt{(-1)^2 + 1^2 + 1^2} = \sqrt{3}$$

Substitute these values into the dot product formula:

$$\cos \theta = \frac{\vec{d}_1 \cdot \vec{d}_2}{|\vec{d}_1||\vec{d}_2|} = \frac{1}{\sqrt{3} \cdot \sqrt{3}} = \frac{1}{3}$$

Therefore, the angle θ is:

$$\theta = \cos^{-1}\left(\frac{1}{3}\right)$$

Hence, the correct option is:

Option A: $\cos^{-1}\left(\frac{1}{3}\right)$

Question 64

$$\text{If } y = \tan^{-1} \left[\frac{\log_e \left(\frac{e}{x^2} \right)}{\log_e (ex^2)} \right] + \tan^{-1} \left[\frac{3+2 \log_e x}{1-6 \cdot \log_e x} \right], \text{ then } \frac{d^2y}{dx^2} =$$

Options:

A.

2

B.

1

C.

0

D.

-1

Answer: C

Question 65

$$\lim_{n \rightarrow \infty} \frac{1}{n^{k+1}} [2^k + 4^k + 6^k + \dots + (2n)^k] =$$

Options:

A.

$\frac{2^k}{k}$

B.

$\frac{2^{k+1}}{k+1}$

C.

$\frac{2^k}{k+1}$

D.

$$\frac{2^k}{k-1}$$

Answer: C

Question 66

The acceleration f ft/sec² of a particle after a time t sec starting from rest is given by $f = 6 - \sqrt{1.2t}$. Then the maximum velocity v and time T to attend this velocity are

Options:

A.

$$T = 20 \text{ sec}$$

B.

$$v = 60 \text{ ft/sec}$$

C.

$$T = 30 \text{ sec}$$

D.

$$v = 40 \text{ ft/sec}$$

Answer: B

Solution:

To find the maximum velocity and the corresponding time when the particle reaches this velocity, we need to analyze the given acceleration function f , which is:

$$f = 6 - \sqrt{1.2t}$$

Step 1: Finding the time T when the acceleration becomes zero

The velocity of the particle will be maximum when the acceleration becomes zero, because acceleration describes the rate of change of velocity. Therefore, we set the acceleration function to zero and solve for t .

$$6 - \sqrt{1.2t} = 0$$

Solving for t :

$$\sqrt{1.2t} = 6$$

$$1.2t = 36$$

$$t = \frac{36}{1.2}$$

$$t = 30 \text{ sec}$$

So, the time T when the acceleration becomes zero and the velocity is at its maximum is 30 seconds. Therefore, Option C is correct.

Step 2: Finding the maximum velocity v

The velocity can be found by integrating the acceleration function with respect to time. Since the particle starts from rest, the initial velocity $v(0)$ is zero.

The velocity function $v(t)$ is given by:

$$v(t) = \int (6 - \sqrt{1.2t}) dt$$

We can solve this integral by splitting it into two parts:

$$v(t) = \int 6 dt - \int \sqrt{1.2t} dt$$

Now, calculate the integral step-by-step:

$$\int 6 dt = 6t$$

For the second integral, let $u = 1.2t$. Then, $du = 1.2 dt$, or $dt = \frac{du}{1.2}$.

$$\int \sqrt{1.2t} dt = \int (\sqrt{u}) \frac{du}{1.2} = \frac{1}{1.2} \int u^{\frac{1}{2}} du$$

$$= \frac{1}{1.2} \cdot \frac{2}{3} u^{\frac{3}{2}} = \frac{2}{3 \cdot 1.2} (1.2t)^{\frac{3}{2}} = \frac{2}{3.6} (1.2t)^{\frac{3}{2}} = \frac{5}{9} (1.2t)^{\frac{3}{2}}$$

Therefore, the velocity function is:

$$v(t) = 6t - \frac{5}{9} (1.2t)^{\frac{3}{2}}$$

Now, substitute $t = 30$ sec to find the maximum velocity:

$$v(30) = 6 \cdot 30 - \frac{5}{9} (1.2 \cdot 30)^{\frac{3}{2}}$$

$$= 180 - \frac{5}{9} (36)^{\frac{3}{2}}$$

$$= 180 - \frac{5}{9} \cdot 216$$

$$= 180 - 120$$

$$= 60 \text{ ft/sec}$$

Therefore, the maximum velocity v is 60 ft/sec. Thus, Option B is correct.

In conclusion, the correct answers are:

Option B: $v = 60$ ft/sec

Option C: $T = 30$ sec

Question 67

Let Γ be the curve $y = be^{-x/a}$ & L be the straight line $\frac{x}{a} + \frac{y}{b} = 1$ where $a, b \in \mathbb{R}$.
Then

Options:

A.

L touches the curve Γ at the point where the curve crosses the axis of y .

B.

L does not touch the curve at the point where the curve crosses the axis of y .

C.

Γ touches the axis of x at a point.

D.

Γ never touches the axis of x .

Answer: A

Solution:

Let's analyze the given curve and line to determine the correct statements.

The curve is given by:

$$\Gamma : y = be^{-x/a}$$

The straight line is given by:

$$L : \frac{x}{a} + \frac{y}{b} = 1$$

First, let's find where the curve Γ crosses the y -axis. This occurs when $x = 0$:

$$y = be^0 = b$$

So, the curve crosses the y -axis at the point $(0, b)$.

Next, let's check whether the line L touches the curve Γ at this point. Substituting $x = 0$ and $y = b$ into the equation of the line L :

$$\frac{0}{a} + \frac{b}{b} = 1$$

This is simplified to:

$$0 + 1 = 1$$

Thus, the point $(0, b)$ lies on the line L .

To determine if the line is tangent to the curve at this point, we need to check if they have the same slope at that point. First, find the derivative of the curve Γ with respect to x :

$$\frac{dy}{dx} = \frac{d}{dx}(be^{-x/a}) = b \cdot \left(-\frac{1}{a}e^{-x/a}\right) = -\frac{b}{a}e^{-x/a}$$

At the point $(0, b)$, the derivative (slope of the curve) is:

$$\frac{dy}{dx} \Big|_{x=0} = -\frac{b}{a}e^0 = -\frac{b}{a}$$

Now, find the slope of the line L . The line equation $\frac{x}{a} + \frac{y}{b} = 1$ can be rearranged to the slope-intercept form:

$$\frac{y}{b} = -\frac{x}{a} + 1$$

or:

$$y = -\frac{b}{a}x + b$$

The slope of the line L is:

$$-\frac{b}{a}$$

Since both the curve Γ and the line L have the same slope $-\frac{b}{a}$ at the point $(0, b)$, the line is tangent to the curve at that point.

Therefore, the correct answer is:

Option A: L touches the curve Γ at the point where the curve crosses the axis of y .

Finally, for completeness, let's evaluate the other options:

Option B: This is incorrect because L does indeed touch the curve at the point where the curve crosses the y -axis.

Option C: The curve Γ never touches the x -axis because as $x \rightarrow \infty$, $y \rightarrow 0$, but it never equals zero.

Option D: This is correct because as analyzed, the curve Γ asymptotically approaches the x -axis but does not touch it.

Question 68

If n is a positive integer, the value of

$$(2n + 1)^n C_0 + (2n - 1)^n C_1 + (2n - 3)^n C_2 + \dots + 1 \cdot {}^n C_n \text{ is}$$

Options:

A.

$$(n + 1)2^n$$

B.

3^n

C.

$f'(2) \text{ where } f(x) = x^{n+1}$

D.

$(n+1)2^{n+1}$

Answer: A

Question 69

If the quadratic equation $ax^2 + bx + c = 0 (a > 0)$ has two roots α and β such that $\alpha < -2$ and $\beta > 2$, then

Options:

A.

$c < 0$

B.

$a + b + c > 0$

C.

$a - b + c < 0$

D.

$a - b + c > 0$

Answer: A

Question 70

If $a_i, b_i, c_i \in \mathbb{R} (i = 1, 2, 3)$ and $x \in \mathbb{R}$ and
$$\begin{matrix} a_1 + b_1x & a_1x + b_1 & c_1 \\ a_2 + b_2x & a_2x + b_2 & c_2 \\ a_3 + b_3x & a_3x + b_3 & c_3 \end{matrix} = 0, \text{ then}$$

Options:

A.

$x = 1$

B.

$$x = -1$$

C.

$$\begin{matrix} a_1 & b_1 & c_1 \\ a_2 & b_2 & c_2 = 0 \\ a_3 & b_3 & c_3 \end{matrix}$$

D.

$$x = 2$$

Answer: A

Question 71

The function $f : \mathbb{R} \rightarrow \mathbb{R}$ defined by $f(x) = e^x + e^{-x}$ is :

Options:

A.

one-one

B.

onto

C.

bijective

D.

not bijective

Answer: D

Solution:

Let's analyze the function $f(x) = e^x + e^{-x}$ where $f : \mathbb{R} \rightarrow \mathbb{R}$.

First, we check if the function is one-one (injective).

An injective function means that if $f(a) = f(b)$, then $a = b$. Let's assume $f(a) = f(b)$.

So, we have:

$$e^a + e^{-a} = e^b + e^{-b}$$

Let's rewrite the equation as:

$$e^a + \frac{1}{e^a} = e^b + \frac{1}{e^b}$$

Given that the exponential function e^x is strictly increasing, and e^{-x} is strictly decreasing, the sum is minimized when $x = 0$. This involves checking various values, but combining these two observations, we can see that the function is symmetric and not strictly monotonic. Therefore, it is not one-one.

Next, we check if the function is onto (surjective).

A surjective function means that for every $y \in \mathbb{R}$, there exists an $x \in \mathbb{R}$ such that $f(x) = y$. Here, considering $f(x) = e^x + e^{-x}$, let's find the range.

Define a new function $g(x) = e^x + e^{-x}$. We use the fact that:

$$g(0) = 2$$

When $x \rightarrow \infty$, then $e^x \rightarrow \infty$ and $e^{-x} \rightarrow 0$, so $g(x) \rightarrow \infty$.

When $x \rightarrow -\infty$, then $e^x \rightarrow 0$ and $e^{-x} \rightarrow \infty$, so $g(x) \rightarrow \infty$.

But at no point does the function $e^x + e^{-x}$ produce negative values. Therefore, the range of $f(x) \geq 2$. Hence, the function is not surjective.

Given that the function is neither injective nor surjective, it cannot be bijective.

Thus, the correct answer is:

Option D: not bijective

Question 72

A square with each side equal to 'a' above the x -axis and has one vertex at the origin. One of the sides passing through the origin makes an angle α ($0 < \alpha < \frac{\pi}{4}$) with the positive direction of the axis. Equation of the diagonals of the square

Options:

A.

$$y(\cos \alpha - \sin \alpha) = x(\sin \alpha + \cos \alpha)$$

B.

$$y(\cos \alpha + \sin \alpha) = x(\cos \alpha - \sin \alpha)$$

C.

$$y(\sin \alpha + \cos \alpha) + x(\cos \alpha - \sin \alpha) = a$$

D.

$$y(\cos \alpha - \sin \alpha) + x(\cos \alpha + \sin \alpha) = a$$

Answer: A

Question 73

If ABC is an isosceles triangle and the coordinates of the base points are $B(1, 3)$ and $C(-2, 7)$. The coordinates of A can be

Options:

A.

$(1, 6)$

B.

$(-\frac{1}{8}, 5)$

C.

$(\frac{5}{6}, 6)$

D.

$(-7, \frac{1}{8})$

Answer: C

Solution:

To determine the possible coordinates of the vertex A in an isosceles triangle ABC with base endpoints $B(1, 3)$ and $C(-2, 7)$, we need to find the coordinates that satisfy the property that $AB = AC$.

Let's calculate the distance between $B(1, 3)$ and potential coordinates of A , as well as between $C(-2, 7)$ and potential coordinates of A .

1. Option A: $A(1, 6)$

$$AB = \sqrt{(1-1)^2 + (6-3)^2} = \sqrt{0+9} = \sqrt{9} = 3$$

$$AC = \sqrt{(1-(-2))^2 + (6-7)^2} = \sqrt{3^2 + (-1)^2} = \sqrt{9+1} = \sqrt{10}$$

Since $AB \neq AC$, Option A is incorrect.

2. Option B: $A(-\frac{1}{8}, 5)$

$$AB = \sqrt{(1 - (-\frac{1}{8}))^2 + (5 - 3)^2} = \sqrt{(1 + \frac{1}{8})^2 + 2^2} = \sqrt{(\frac{8}{8} + \frac{1}{8})^2 + 4} = \sqrt{(\frac{9}{8})^2 + 4} = \sqrt{\frac{81}{64} + \frac{256}{64}} = \sqrt{\frac{337}{64}} = \sqrt{5.27}$$

$$AC = \sqrt{(-\frac{1}{8} - (-2))^2 + (5 - 7)^2} = \sqrt{(-\frac{1}{8} + 2)^2 + (-2)^2} = \sqrt{(\frac{15}{8})^2 + 4} = \sqrt{\frac{225}{64} + \frac{256}{64}} = \sqrt{\frac{481}{64}} = \sqrt{7.52}$$

Since $AB \neq AC$, Option B is incorrect.

3. Option C: $A(\frac{5}{6}, 6)$

$$AB = \sqrt{(1 - \frac{5}{6})^2 + (6 - 3)^2} = \sqrt{(\frac{6}{6} - \frac{5}{6})^2 + 3^2} = \sqrt{(\frac{1}{6})^2 + 9} = \sqrt{\frac{1}{36} + \frac{324}{36}} = \sqrt{\frac{325}{36}} = \sqrt{9.03}$$

$$AC = \sqrt{\left(\frac{5}{6} - (-2)\right)^2 + (6 - 7)^2} = \sqrt{\left(\frac{5}{6} + \frac{12}{6}\right)^2 + (-1)^2} = \sqrt{\left(\frac{17}{6}\right)^2 + 1} = \sqrt{\frac{289}{36} + \frac{36}{36}} = \sqrt{\frac{325}{36}} = \sqrt{9.03}$$

Since $AB = AC$, Option C is correct.

4. Option D: $A\left(-7, \frac{1}{8}\right)$

$$AB = \sqrt{(1 - (-7))^2 + \left(3 - \frac{1}{8}\right)^2} = \sqrt{8^2 + \left(\frac{24}{8} - \frac{1}{8}\right)^2} = \sqrt{64 + \left(\frac{23}{8}\right)^2} = \sqrt{64 + \frac{529}{64}} = \sqrt{\frac{4096+529}{64}} = \sqrt{\frac{4625}{64}} = \sqrt{72.27}$$

$$AC = \sqrt{(-7 - (-2))^2 + \left(\frac{1}{8} - 7\right)^2} = \sqrt{(-5)^2 + \left(\frac{1}{8} - \frac{56}{8}\right)^2} = \sqrt{25 + \left(-\frac{55}{8}\right)^2} = \sqrt{25 + \frac{3025}{64}} = \sqrt{\frac{1600+3025}{64}} = \sqrt{\frac{4625}{64}} = \sqrt{72}$$

Since $AB = AC$, Option D is also correct.

Therefore, the correct coordinates of A can be Option C: $A\left(\frac{5}{6}, 6\right)$ or Option D: $A\left(-7, \frac{1}{8}\right)$.

Question 74

The points of extremum of $\int_0^{x^2} \frac{t^2 - 5t + 4}{2 + e^t} dt$ are

Options:

A.

± 1

B.

± 2

C.

± 3

D.

$\pm \sqrt{2}$

Answer: A

Solution:

In order to find the points of extremum of the given integral, we start by considering the integral:

$$\int_0^{x^2} \frac{t^2 - 5t + 4}{2 + e^t} dt$$

Let's denote this integral by $F(x)$.

We need to find the critical points of $F(x)$, which are the points where its derivative with respect to x is zero. Since $F(x)$ is an integral with an upper limit that depends on x , we will use the Leibniz rule for differentiation under the integral sign:

$$\frac{d}{dx} \int_{a(x)}^{b(x)} f(t, x) dt = f(b(x), x) \frac{d}{dx} b(x) - f(a(x), x) \frac{d}{dx} a(x) + \int_{a(x)}^{b(x)} \frac{\partial}{\partial x} f(t, x) dt$$

In our case, the lower limit is 0 and is independent of x , so its derivative is zero. The function inside the integral does not explicitly depend on x , so the partial derivative with respect to x is zero. Hence, we simplify to:

$$\frac{d}{dx} F(x) = \frac{d}{dx} \int_0^{x^2} \frac{t^2 - 5t + 4}{2 + e^t} dt = \frac{t^2 - 5t + 4}{2 + e^t} \Big|_0^{x^2} \cdot \frac{d}{dx} (x^2)$$

Since the value of the integral at the lower limit is zero, we get:

$$\frac{d}{dx} F(x) = \frac{(x^2)^2 - 5(x^2) + 4}{2 + e^{x^2}} \cdot 2x$$

Simplifying the expression inside the fraction, we have:

$$\frac{d}{dx} F(x) = \frac{x^4 - 5x^2 + 4}{2 + e^{x^2}} \cdot 2x$$

To find the critical points, we must set the derivative equal to zero:

$$\frac{x^4 - 5x^2 + 4}{2 + e^{x^2}} \cdot 2x = 0$$

The fraction is zero if and only if the numerator is zero. Thus, we solve:

$$(x^4 - 5x^2 + 4) \cdot 2x = 0$$

This simplifies to two cases:

$$2x(x^4 - 5x^2 + 4) = 0$$

From the above equation, set each factor to zero:

$$2x = 0 \Rightarrow x = 0$$

and

$$x^4 - 5x^2 + 4 = 0$$

Letting $y = x^2$, we convert the quartic equation to a quadratic one:

$$y^2 - 5y + 4 = 0$$

Solving this quadratic equation by factoring:

$$(y - 1)(y - 4) = 0$$

So,

$$y = 1 \quad \text{or} \quad y = 4$$

Since $y = x^2$, we have:

$$x^2 = 1 \quad \Rightarrow \quad x = \pm 1$$

$$x^2 = 4 \quad \Rightarrow \quad x = \pm 2$$

Thus, the points of extremum are:

Option A: ± 1

Option B: ± 2

Therefore, the correct answer is both Option A and Option B.

Question 75

Choose the correct statement :

Options:

A.

$x + \sin 2x$ is a periodic function

B.

$x + \sin 2x$ is not a periodic function

C.

$\cos(\sqrt{x} + 1)$ is a periodic function

D.

$\cos(\sqrt{x} + 1)$ is not a periodic function

Answer: B

Solution:

To determine whether the functions are periodic, we need to see if there exists a positive constant T such that $f(x + T) = f(x)$ for all x in the domain of the function. Let's analyze each option one by one.

Option A: $x + \sin 2x$ is a periodic function

The function $x + \sin 2x$ consists of a linear term x and a periodic term $\sin 2x$. The linear term x is not periodic because it continuously increases or decreases without repeating any values. Therefore, the sum $x + \sin 2x$ cannot be periodic because the non-periodic linear term dominates the behavior of the function as x increases.

Option B: $x + \sin 2x$ is not a periodic function

As explained above, the function $x + \sin 2x$ is not periodic due to the presence of the linear term x . Thus, this statement is correct.

Option C: $\cos(\sqrt{x} + 1)$ is a periodic function

To determine the periodicity of $\cos(\sqrt{x} + 1)$, we need to check if there exists a positive constant T such that $\cos(\sqrt{x + T} + 1) = \cos(\sqrt{x} + 1)$ for all x . However, the argument of the cosine function, $\sqrt{x} + 1$, is not periodically repeating as x increases. The function \sqrt{x} increases without bound, thus the argument of the cosine function does not repeat its values periodically.

Option D: $\cos(\sqrt{x} + 1)$ is not a periodic function

As explained above, the argument $\sqrt{x} + 1$ does not repeat periodically, so $\cos(\sqrt{x} + 1)$ is not a periodic function. Thus, this statement is correct.

Therefore, the correct statements are:

Option B: $x + \sin 2x$ is not a periodic function

Option D: $\cos(\sqrt{x} + 1)$ is not a periodic function

Chemistry

Question 76

In the following sequence of reaction compound 'M' is

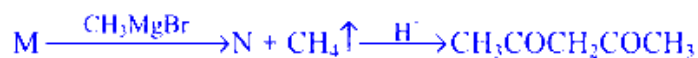

Options:

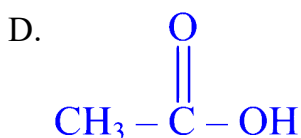
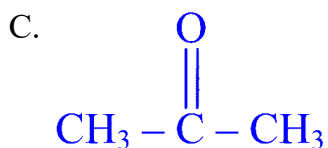

Answer: A

Solution:

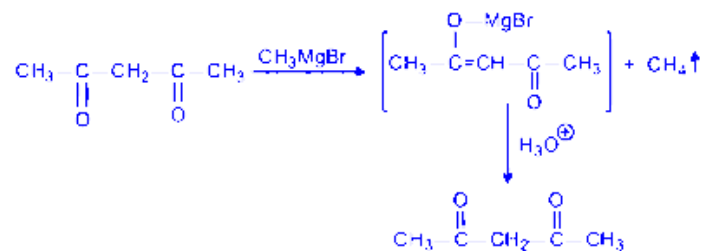

Question 77

Identify the ion having $4f^6$ electronic configuration.

Options:



B.



C.

Sm²⁺

D.

Tb³⁺

Answer: C

Solution:

To identify the ion having the $4f^6$ electronic configuration, we need to look at the electron configurations of the given ions. The f-block elements, also known as the lanthanides, typically fill their 4f orbitals as we move across the series.

The atomic numbers and electron configurations of some relevant lanthanides are as follows:

- **Samarium (Sm):** Atomic number = 62, Configuration: $[Xe]4f^66s^2$
- **Gadolinium (Gd):** Atomic number = 64, Configuration: $[Xe]4f^75d^16s^2$
- **Terbium (Tb):** Atomic number = 65, Configuration: $[Xe]4f^96s^2$

Now let's examine the electronic configurations of the ions given in the options:

1. **Gd³⁺:** Gadolinium loses three electrons to form the ion. This typically means losing two 6s electrons and one 5d electron:

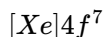

2. **Sm³⁺:** Samarium loses three electrons to form the ion, usually removing the two 6s electrons and one 4f electron:

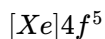

3. **Sm²⁺:** Samarium loses two electrons to form the ion, typically losing only the two 6s electrons:

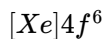

4. **Tb³⁺:** Terbium loses three electrons to form the ion, generally removing the two 6s electrons and one 4f electron:

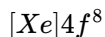

Among the options, the ion with the $4f^6$ electronic configuration is Sm²⁺. This configuration is obtained after Samarium loses its two 6s electrons.

Therefore, the correct answer is:

Option C: Sm²⁺

Question 78

Metallic conductors and semiconductors are heated separately. What are the changes with respect to conductivity?

Options:

A.

increase, decrease

B.

decrease, decrease

C.

increase, decrease

D.

decrease, increase

Answer: D

Solution:

The changes in conductivity for metallic conductors and semiconductors when they are heated can be understood by examining their electronic properties and how these properties respond to temperature changes:

Metallic Conductors:

In metallic conductors, conductivity depends largely on the movement of free electrons. As temperature increases, the metal's atomic lattice vibrates more vigorously, causing more frequent collisions between free electrons and the lattice atoms. These increased collisions impede electron flow, thereby decreasing the metal's conductivity. Thus, the conductivity of metallic conductors **decreases** with an increase in temperature.

Semiconductors:

Semiconductors, on the other hand, behave differently. Their conductivity is highly sensitive to temperature changes. At low temperatures, semiconductors have few charge carriers because their electrons are bound closely to atoms. As the temperature rises, more electrons gain enough thermal energy to jump from the valence band to the conduction band, creating electron-hole pairs and thereby increasing the number of charge carriers available for conduction. As a result, the conductivity of semiconductors **increases** with an increase in temperature.

To summarize:

- **Metallic Conductors:** Conductivity **decreases** with an increase in temperature.
- **Semiconductors:** Conductivity **increases** with an increase in temperature.

Therefore, the correct answer is:

Option D: decrease, increase

Question 79

The equivalent weight of $\text{Na}_2\text{S}_2\text{O}_3$ (Gram molecular weight = M) in the given reaction is

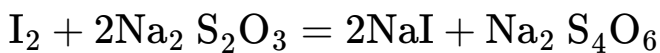

Options:

A.

$M/2$

B.

M

C.

$2M$

D.

$M/4$

Answer: B

Solution:

The equivalent weight of a substance is the weight of the substance that reacts with or is equivalent to one mole of hydrogen ions or one mole of electrons. In this reaction, the oxidation state of sulfur in $\text{Na}_2\text{S}_2\text{O}_3$ is +2, while in $\text{Na}_2\text{S}_4\text{O}_6$ it is +2.5. This means that each sulfur atom in $\text{Na}_2\text{S}_2\text{O}_3$ loses 0.5 electrons. Since there are two sulfur atoms per molecule of $\text{Na}_2\text{S}_2\text{O}_3$, the total number of electrons lost per molecule is 1. Therefore, the equivalent weight of $\text{Na}_2\text{S}_2\text{O}_3$ is equal to its molecular weight divided by the number of electrons lost per molecule, which is $M/1$ or simply M .

So the answer is **Option B**.

Question 80

The reactivity order of the following molecules towards $\text{S}_{\text{N}}1$ reaction is

Allyl chloride

(I)

Chlorobenzene

(II)

Ethyl chloride

(III)

Options:

A.

$\text{I} > \text{II} > \text{III}$

B.

I > III > II

C.

II > I > III

D.

III > I > II

Answer: B

Solution:

The correct answer is **Option B: I > III > II**. Here's why:

The S_N1 reaction proceeds through a two-step mechanism:

1. **Step 1: Formation of carbocation:** This step involves the ionization of the alkyl halide to form a carbocation. The rate of this step depends on the stability of the carbocation formed. More stable carbocations form faster and thus lead to faster S_N1 reaction.
2. **Step 2: Nucleophilic attack:** This step involves the attack of the nucleophile on the carbocation to form the product.

Let's analyze the stability of carbocations formed from each molecule:

I. Allyl Chloride:

The carbocation formed from allyl chloride is resonance stabilized:

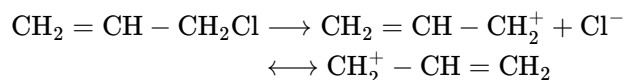

This resonance stabilization makes the allyl carbocation very stable.

II. Chlorobenzene:

Chlorobenzene does not easily form a carbocation because the benzene ring is highly stable and aromatic. The formation of a carbocation would disrupt this aromaticity, which is energetically unfavorable. Therefore, chlorobenzene is relatively unreactive towards the S_N1 reaction.

III. Ethyl Chloride:

Ethyl chloride forms a simple ethyl carbocation, which is less stable than a resonance-stabilized carbocation but more stable than a primary carbocation found in many other alkyl halides. However, it is still less stable than the allyl carbocation.

Therefore, the order of reactivity towards S_N1 reaction is: **Allyl chloride (I) > Ethyl chloride (III) > Chlorobenzene (II)**.

This is because the resonance-stabilized allyl carbocation (I) is the most stable, followed by the ethyl carbocation (III), and finally, the chlorobenzene (II), which does not favor carbocation formation due to the loss of aromaticity.

Question 81

Toluene reacts with mixed acid at 25°C to produce

Options:

A.

nearly equal amounts of *o*- and *m*- nitrotoluene

B.

p only

C.

predominantly *o*- nitrotoluene and *p*- nitrotoluene

D.

2, 4, 6-trinitrotoluene (only)

Answer: C

Solution:

Toluene, which is also known as methylbenzene, undergoes nitration when reacted with mixed acid, typically a mixture of concentrated nitric acid (HNO_3) and concentrated sulfuric acid (H_2SO_4). This reaction introduces a nitro group ($-\text{NO}_2$) onto the benzene ring of toluene. The methyl group ($-\text{CH}_3$) attached to the benzene ring is an electron-donating group (EDG) and it activates the ortho (2 and 6) and para (4) positions on the ring, making them more susceptible to electrophilic substitution reactions.

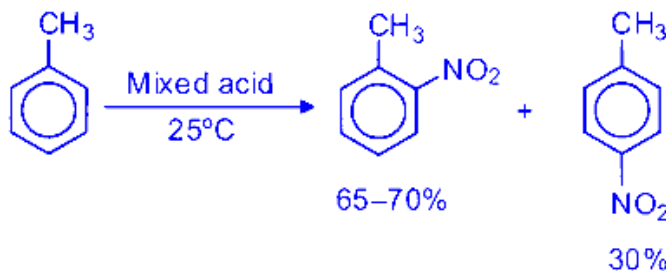

Among the given options, let's evaluate them in detail:

Option A: This suggests that toluene produces nearly equal amounts of *o*- nitrotoluene (ortho-nitrotoluene) and *m*- nitrotoluene (meta-nitrotoluene). However, because the methyl group is an activating and ortho/para-directing group, meta-nitrotoluene is produced in very minor amounts compared to ortho and para isomers.

Option B: This suggests that the reaction only produces *p*- nitrotoluene. While the para isomer is one of the products, it is not the only product. The ortho isomer is also formed in significant amounts.

Option C: This option suggests that the reaction predominately produces *o*- nitrotoluene and *p*- nitrotoluene. This is correct because the methyl group directs the nitration to the ortho and para positions on the benzene ring.

Option D: This suggests that the reaction produces 2, 4, 6-trinitrotoluene (TNT) only. This is not true at the given condition (25°C), as the formation of TNT requires more stringent conditions including higher temperature and multiple steps of nitration.

Therefore, the correct answer is:

Option C: predominantly *o*- nitrotoluene and *p*- nitrotoluene

Question 82

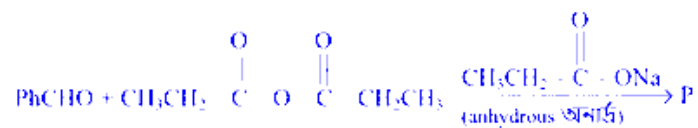

The product 'P' in the above reaction is

Options:

A.



B.

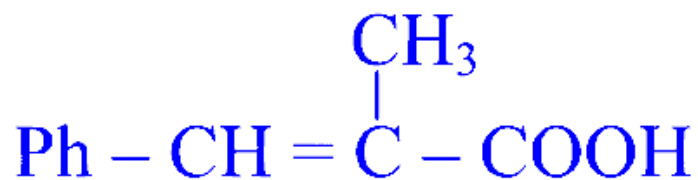

C.

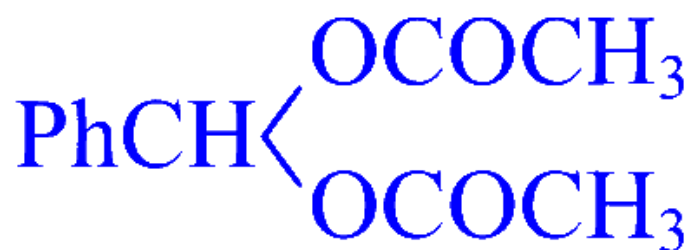

D.

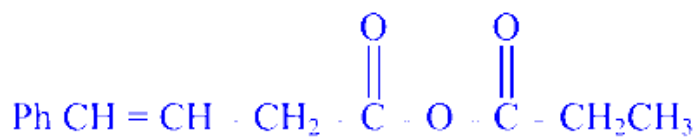

Answer: B

Solution:

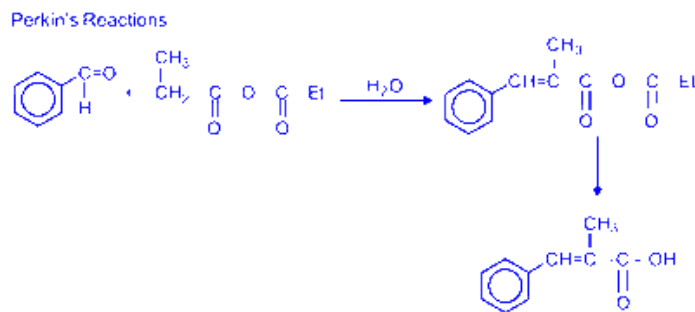

Question 83

The decreasing order of reactivity of the following alkenes towards HBr addition is

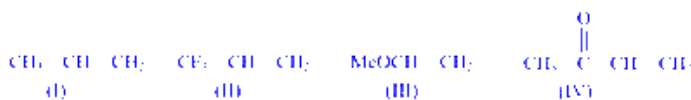

Options:

A.

I > II > III > IV

B.

II > IV > I > III

C.

III > IV > I > II

D.

III > I > II > IV

Answer: D

Solution:

To determine the decreasing order of reactivity of the given alkenes towards hydrogen bromide (HBr) addition, we need to consider the stability of the carbocation intermediate formed during the reaction. The more stable the carbocation, the more reactive the alkene is toward HBr addition.

The stability of carbocations follows the order: tertiary > secondary > primary > methyl. Additionally, resonance stabilization and hyperconjugation can further affect the stability.

Let's analyze each alkene:

1. **Alkene I:** This alkene forms a secondary carbocation intermediate after HBr addition.
2. **Alkene II:** This alkene forms a primary carbocation intermediate after HBr addition.

3. **Alkene III:** This alkene forms a tertiary carbocation intermediate after HBr addition, which is the most stable among the options.
4. **Alkene IV:** This alkene can form a secondary carbocation that benefits from resonance stabilization with the adjacent benzene ring, thus enhancing its stability.

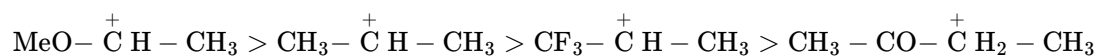

Based on the stability of the carbocation intermediates:

- Alkene III forms the most stable tertiary carbocation.
- Alkene IV forms a secondary carbocation stabilized by resonance.
- Alkene I forms a secondary carbocation without additional stabilization.
- Alkene II forms a less stable primary carbocation.

Thus, the decreasing order of reactivity towards HBr addition is:



Therefore, the correct option is:

Option D: III > I > II > IV

Question 84

Ozonolysis of o-xylene produces

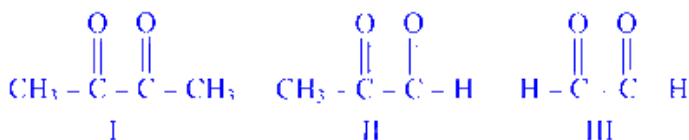

Options:

A.

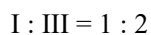

B.

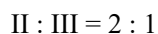

C.

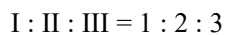

D.

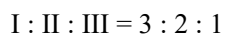

Answer: C

Solution:

Orthoxylene can remain in two structure

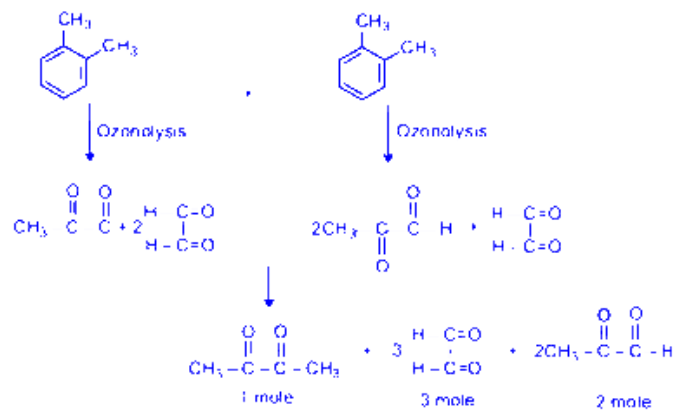

Question 85

The compounds **A** and **B** are respectively

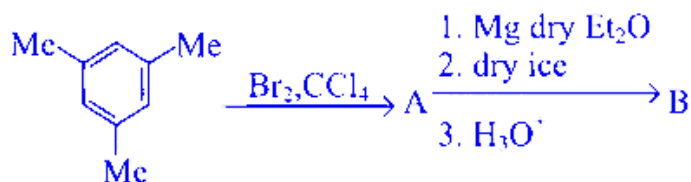

Options:

A.

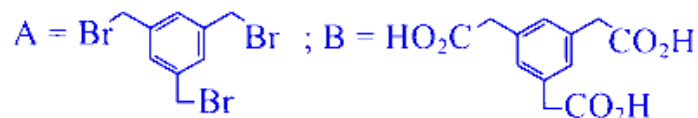

B.

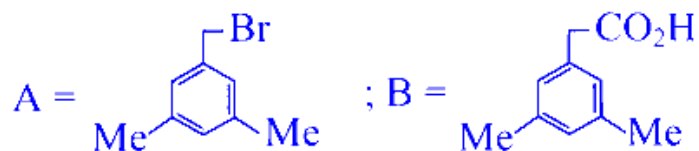

C.

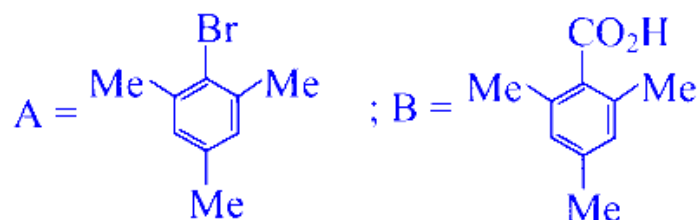

D.

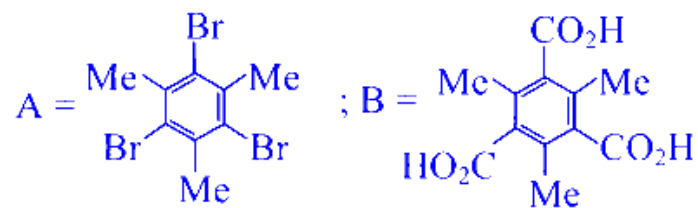

Answer: C

Solution:

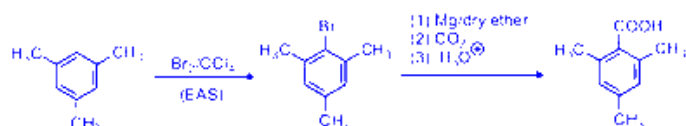

Question 86

The compound that does not give positive test for nitrogen in Lassaigne's test is

Options:

A.



B.

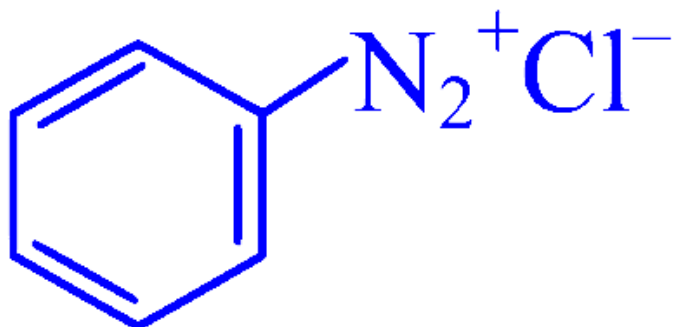

C.

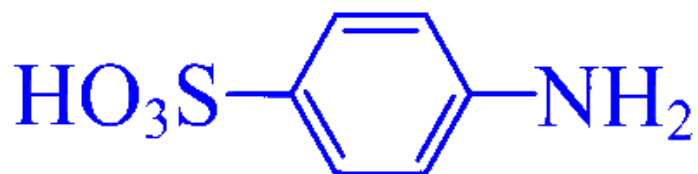

D.

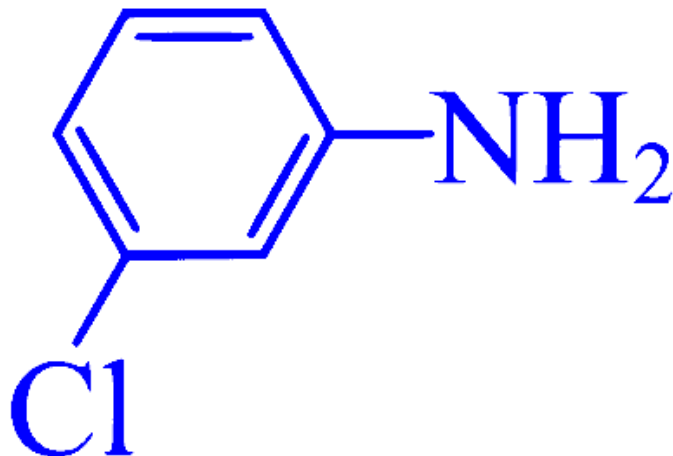

Answer: B

Solution:

N_2 gas will release during fusion with sodium.

Question 87

The correct acidity order of phenol (I), 4-hydroxybenzaldehyde (II) and 3-hydroxybenzaldehyde (III) is

Options:

A.

$\text{I} < \text{II} < \text{III}$

B.

$\text{I} < \text{III} < \text{II}$

C.

$\text{II} < \text{III} < \text{I}$

D.

$\text{III} < \text{II} < \text{I}$

Answer: B

Solution:

To determine the correct acidity order of phenol (I), 4-hydroxybenzaldehyde (II), and 3-hydroxybenzaldehyde (III), we need to consider the electron-withdrawing or electron-donating effects of the substituents on the phenol ring and how these affect the stability of the phenoxide ion after deprotonation.

Phenol (I) has the structure:

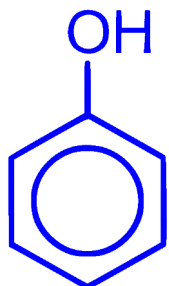

(I)

In 4-hydroxybenzaldehyde (II), the aldehyde group (CHO) is at the para position relative to the hydroxyl group:

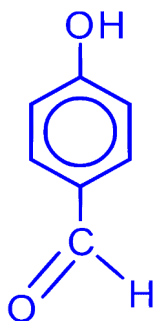

(II)

(-I, -R)

In 3-hydroxybenzaldehyde (III), the aldehyde group (CHO) is at the meta position relative to the hydroxyl group:

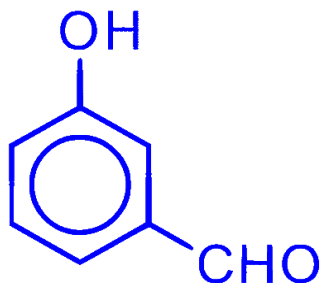

(III)

(-I)

The presence of the electron-withdrawing aldehyde group influences the acidity of the phenol by stabilizing the negative charge on the oxygen atom of the phenoxide ion. This stabilization is more significant when the aldehyde group is closer (para position) or less steric hindered compared to the hydroxyl group.

1. **Phenol (I)**: Has no additional electron-withdrawing groups to stabilize the phenoxide ion, thus has the least acidity.

1. **4-Hydroxybenzaldehyde (II)**: The CHO group at the para position significantly withdraws electron density through both inductive and resonance effects, stabilizing the phenoxide ion more effectively than at the meta position.

2. **3-Hydroxybenzaldehyde (III)**: The CHO group at the meta position primarily withdraws electron density through inductive effects, which is less stabilizing than the para position incorporation.

Therefore, the correct acidity order is:

Phenol (I) < 3-Hydroxybenzaldehyde (III) < 4-Hydroxybenzaldehyde (II)

This corresponds to Option B:

I < III < II

Question 88

The major product of the following reaction is :

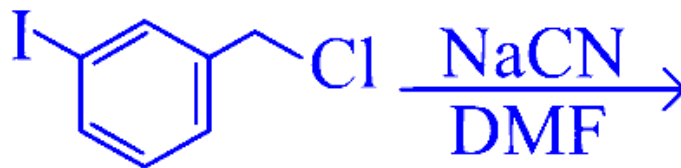

Options:

A.

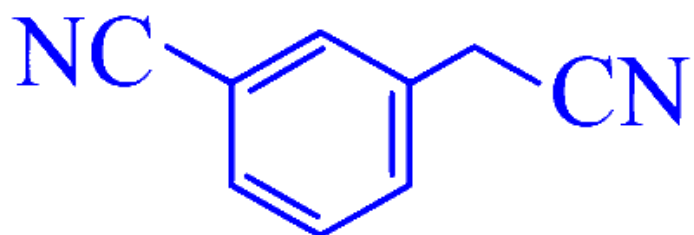

B.

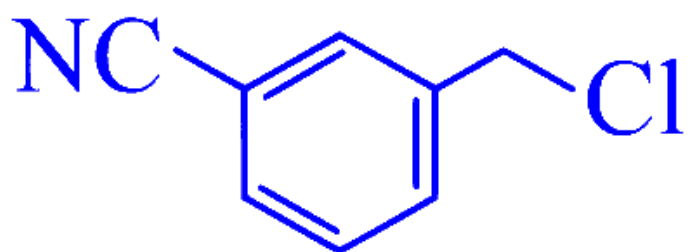

C.

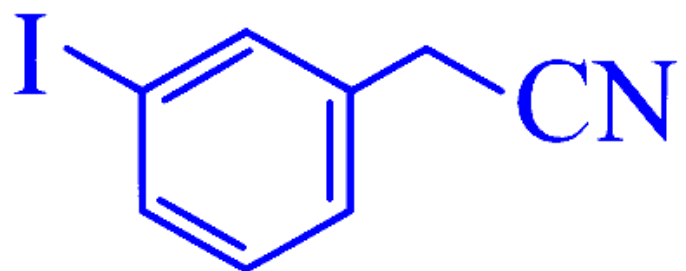

D.

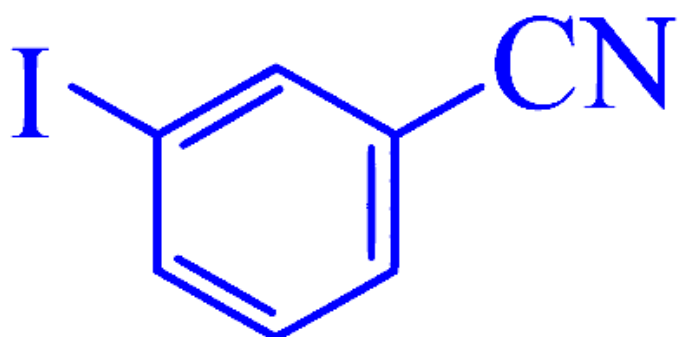

Answer: C

Solution:

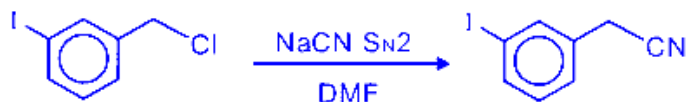

Question 89

Which of the following statements is correct for a spontaneous polymerization reaction ?

Options:

A.

$$\Delta G < 0, \Delta H < 0, \Delta S < 0$$

B.

$$\Delta G < 0, \Delta H > 0, \Delta S > 0$$

C.

$$\Delta G > 0, \Delta H < 0, \Delta S > 0$$

D.

$$\Delta G > 0, \Delta H > 0, \Delta S > 0$$

Answer: A

Solution:

In thermodynamics, a spontaneous reaction is one that occurs naturally without needing to be driven by external forces. The spontaneity of a reaction is primarily determined by the Gibbs free energy change (ΔG). For a reaction to be spontaneous, the Gibbs free energy change must be negative (i.e., $\Delta G < 0$). The Gibbs free energy is related to the enthalpy change (ΔH) and the entropy change (ΔS) by the equation:

$$\Delta G = \Delta H - T\Delta S$$

where T is the absolute temperature in Kelvin.

For polymerization reactions, typically they involve the formation of long-chain molecules from smaller monomer units. During this process:

- **Enthalpy Change (ΔH):** Generally, polymerization reactions are exothermic (release heat), so ΔH is often negative.
- **Entropy Change (ΔS):** Polymerization leads to a decrease in randomness since individual monomers form a more ordered polymer. Therefore, ΔS is usually negative.

Given that a spontaneous reaction requires $\Delta G < 0$, and considering the typical characteristics of polynomial reactions, the correct conditions should be:

- $\Delta G < 0$
- $\Delta H < 0$
- $\Delta S < 0$

So, option A $\Delta G < 0, \Delta H < 0, \Delta S < 0$ is the correct one for a spontaneous polymerization reaction.

Question 90

At 25°C, the ionic product of water is 10^{-14} . The free energy change for the self-ionization of water in kCal mol^{-1} is close to

Options:

- A.
20.5
- B.
14.0
- C.
19.1
- D.
25.3

Answer: C

Solution:

To determine the free energy change (ΔG) for the self-ionization of water, we can use the relation between the equilibrium constant (K_w) and the Gibbs free energy change. The formula is given by:

$$\Delta G = -RT \ln K_w$$

where:

- R is the universal gas constant, which is approximately $1.987 \text{ cal mol}^{-1} \text{ K}^{-1}$.
- T is the temperature in Kelvin. At 25°C, the temperature is 298 K.
- K_w is the ionic product of water, given as 10^{-14} .

First, convert the given units of R to $\text{kcal mol}^{-1} \text{ K}^{-1}$:

$$R = 1.987 \text{ cal mol}^{-1} \text{ K}^{-1} \times \frac{1 \text{ kcal}}{1000 \text{ cal}} = 0.001987 \text{ kcal mol}^{-1} \text{ K}^{-1}$$

Now, substitute the values into the Gibbs free energy equation:

$$\Delta G = -(0.001987 \text{ kcal mol}^{-1} \text{ K}^{-1}) \times 298 \text{ K} \times \ln(10^{-14})$$

Calculate the natural logarithm of 10^{-14} :

$$\ln(10^{-14}) = -14 \ln(10) \approx -14 \times 2.303 = -32.242$$

Substitute this value back into the equation:

$$\Delta G = -(0.001987 \text{ kcal mol}^{-1} \text{ K}^{-1}) \times 298 \text{ K} \times (-32.242)$$

Now perform the multiplication:

$$\Delta G = 0.001987 \times 298 \times 32.242$$

$$\Delta G \approx 19.1 \text{ kcal mol}^{-1}$$

Therefore, the free energy change for the self-ionization of water at 25°C is close to 19.1 kcal mol⁻¹.

The correct answer is:

Option C: 19.1

Question 91

Consider an electron moving in the first Bohr orbit of a He⁺ ion with a velocity v_1 . If it is allowed to move in the third Bohr orbit with a velocity v_3 , then indicate the correct $v_3 : v_1$ ratio.

Options:

A.

3 : 1

B.

2 : 1

C.

1 : 3

D.

1 : 2

Answer: C

Solution:

In the Bohr model, the velocity of an electron in an orbit is inversely proportional to the radius of that orbit for a given atom or ion. Specifically, the velocity v of an electron in the n th orbit of a hydrogen-like atom (or ion) is given by:

$$v_n = \frac{k}{n}$$

Where k is a constant for a particular atom/ion and n is the principal quantum number of the orbit (1 for the first orbit, 2 for the second, etc.).

From this relationship, it follows that the velocity of the electron decreases as the principal quantum number increases. Specifically, for the electron in the first Bohr orbit ($n = 1$) and the third Bohr orbit ($n = 3$) of the He^+ ion, the velocities v_1 and v_3 would be directly related by the ratio of their orbit numbers. Thus:

$$\frac{v_3}{v_1} = \frac{\frac{k}{3}}{\frac{k}{1}} = \frac{1}{3}$$

Therefore, the velocity ratio $v_3 : v_1$ is $1 : 3$. This indicates that the electron in the third orbit moves at one-third the velocity of the electron in the first orbit.

Hence, the correct answer is **Option C: 1 : 3**.

Question 92

The compressibility factor for a van der Waal gas at high pressure is

Options:

A.

$$1 + \frac{RT}{Pb}$$

B.

$$1 + \frac{Pb}{RT}$$

C.

$$1 - \frac{Pb}{RT}$$

D.

1

Answer: B

Solution:

The compressibility factor (Z) is a measure of how much a real gas deviates from ideal gas behavior. For an ideal gas, the compressibility factor is 1. For real gases, Z can be less than or greater than 1 depending on the conditions, such as pressure and temperature.

The van der Waals equation for real gases is given by:

$$\left(P + \frac{a}{V_m^2}\right)(V_m - b) = RT$$

Where:

- P is the pressure
- V_m is the molar volume
- R is the universal gas constant
- T is the temperature
- a and b are van der Waals constants for the gas

At high pressures, the term $\frac{a}{V_m^2}$ becomes negligible, and the van der Waals equation can be approximated as:

$$P(V_m - b) = RT$$

Rearranging for V_m , we get:

$$V_m = \frac{RT}{P} + b$$

The compressibility factor Z is defined as:

$$Z = \frac{PV_m}{RT}$$

Substituting the expression for V_m into the definition of Z , we get:

$$Z = \frac{P\left(\frac{RT}{P} + b\right)}{RT}$$

Simplifying this expression gives us:

$$Z = 1 + \frac{Pb}{RT}$$

Thus, the compressibility factor for a van der Waals gas at high pressure is:

Option B: $1 + \frac{Pb}{RT}$

Question 93

For a spontaneous process, the incorrect statement is

Options:

A.

$$(\Delta G_{\text{system}})_{T,P} > 0$$

B.

$$(\Delta S_{\text{system}}) + (\Delta S_{\text{surroundings}}) > 0$$

C.

$$(\Delta G_{\text{system}})_{T,P} < 0$$

D.

$$(\Delta U_{\text{system}})_{S,v} < 0$$

Answer: A

Solution:

To determine the incorrect statement for a spontaneous process, let's review some basic thermodynamic principles associated with spontaneity and Gibbs free energy (G), entropy (S), and internal energy (U).

For a process to be spontaneous, certain conditions need to be met:

1. The change in Gibbs free energy at constant temperature (T) and pressure (P), ΔG_{system} , must be negative:

$$(\Delta G_{\text{system}})_{T,P} < 0$$

2. The total entropy change, which is the sum of the entropy change in the system and the entropy change in the surroundings, must be positive:

$$(\Delta S_{\text{system}}) + (\Delta S_{\text{surroundings}}) > 0$$

With these in mind, let's assess the given options:

Option A:

This states:

$$(\Delta G_{\text{system}})_{T,P} > 0$$

This is incorrect for a spontaneous process since, as mentioned, the Gibbs free energy change should be negative for spontaneity.

Option B:

This states:

$$(\Delta S_{\text{system}}) + (\Delta S_{\text{surroundings}}) > 0$$

This is correct because the overall entropy change for a spontaneous process must be positive.

Option C:

This states:

$$(\Delta G_{\text{system}})_{T,P} < 0$$

This is correct, as ΔG should be negative for a spontaneous process.

Option D:

This states:

$$(\Delta U_{\text{system}})_{S,v} < 0$$

This describes the change in internal energy at constant entropy (S) and volume (v). This is not directly related to the criteria for spontaneity, making it neither correct nor incorrect within this context. However, it's not a standard criterion for determining spontaneity.

The incorrect statement regarding spontaneity is clearly:

Option A:

$$(\Delta G_{\text{system}})_{T,P} > 0$$

Question 94

Identify the incorrect statement among the following :

Options:

A.

Viscosity of liquid always decreases with increase in temperature.

B.

Surface tension of liquid always decreases with increase in temperature.

C.

Viscosity of liquid always increases in presence of impurity.

D.

Surface tension of liquid always increases in presence of impurity.

Answer: C

Solution:

Let's analyze each statement to determine which one is incorrect.

Option A: Viscosity of liquid always decreases with increase in temperature.

This statement is generally true for most liquids. As temperature increases, the kinetic energy of molecules also increases, leading to a reduction in the intermolecular forces that contribute to viscosity, hence reducing the viscosity.

Option B: Surface tension of liquid always decreases with increase in temperature.

This statement is also generally true. As temperature increases, the cohesive forces between molecules at the surface decrease, which lowers surface tension.

Option C: Viscosity of liquid always increases in presence of impurity.

This statement is incorrect. The effect of impurities on viscosity can vary depending on the nature of the impurity and the liquid. Some impurities may increase viscosity, while others may decrease it. For example, adding sugar to water increases its viscosity, whereas adding alcohol decreases it.

Option D: Surface tension of liquid always increases in presence of impurity.

This statement is also incorrect. The effect of impurities on surface tension depends on the nature of the impurity. For instance, detergents added to water reduce its surface tension, while some other impurities may increase it.

Therefore, the incorrect statement is:

Option C: Viscosity of liquid always increases in presence of impurity.

Question 95

Which of the following statements is true about equilibrium constant and rate constant of a single step chemical reaction?

Options:

A.

Equilibrium constant may increase or decrease but rate constant always increases with temperature.

B.

Both equilibrium constant and rate constant increase with temperature.

C.

Rate constant may increase or decrease but equilibrium constant always increases with temperature.

D.

Both equilibrium constant and rate constant decrease with temperature.

Answer: A

Solution:

To understand the relationship between the equilibrium constant and the rate constant with temperature for a single-step chemical reaction, we need to consider the following concepts:

Rate Constant (k):

The rate constant of a reaction is influenced by temperature according to the Arrhenius equation:

$$k = Ae^{-\frac{E_a}{RT}}$$

where A is the pre-exponential factor, E_a is the activation energy, R is the gas constant, and T is the temperature in Kelvin. From this equation, it's clear that the rate constant k generally increases with an increase in temperature.

Equilibrium Constant (K_{eq}):

The equilibrium constant is related to the Gibbs free energy change (ΔG°) of the reaction:

$$\Delta G^\circ = -RT \ln K_{eq}$$

If the reaction's ΔH is positive (endothermic), an increase in temperature results in an increase in K_{eq} . Conversely, for an exothermic reaction (ΔH is negative), an increase in temperature results in a decrease in K_{eq} . This is described by the van 't Hoff equation:

$$\left(\frac{d \ln K_{\text{eq}}}{dT}\right) = \frac{\Delta H^\circ}{RT^2}$$

Thus, the behavior of the equilibrium constant with temperature depends on the nature of the reaction (whether it is endothermic or exothermic).

Given the above explanation, the correct answer is:

Option A: Equilibrium constant may increase or decrease but the rate constant always increases with temperature.

Question 96

After the emission of a β -particle followed by an α -particle from ${}_{83}^{214}\text{Bi}$, the number of neutrons in the atom is -

Options:

A.

210

B.

128

C.

129

D.

82

Answer: B

Solution:

To determine the number of neutrons in the atom after the emission of a β -particle and an α -particle from ${}_{83}^{214}\text{Bi}$, we need to understand how these emissions affect the atomic and mass numbers.

1. Emission of a β -particle:

A β -particle is essentially an electron, and its emission converts a neutron into a proton. Therefore, the atomic number increases by 1, but the mass number remains the same. For ${}_{83}^{214}\text{Bi}$ (bismuth), after the emission of a β -particle, the atomic number becomes 84:

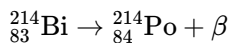

2. Emission of an α -particle:

An α -particle consists of 2 protons and 2 neutrons, so its emission decreases the atomic number by 2 and the mass number by 4. Therefore, for ${}_{84}^{214}\text{Po}$ (polonium), after the emission of an α -particle, the atomic number becomes 82 and the mass number

becomes 210:

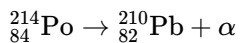

Now, we need to find the number of neutrons in the resulting atom, ${}_{82}^{210}\text{Pb}$ (lead). The number of neutrons is given by the difference between the mass number and the atomic number:

Number of neutrons = Mass number – Atomic number

$$\text{Number of neutrons} = 210 - 82 = 128$$

Therefore, the correct answer is:

Option B

128

Question 97

Which hydrogen like species will have the same radius as that of 1st Bohr orbit of hydrogen atom?

Options:

A.

$$n = 2, \text{Li}^{2+}$$

B.

$$n = 2, \text{Be}^{3+}$$

C.

$$n = 2, \text{He}^{+}$$

D.

$$n = 3, \text{Li}^{2+}$$

Answer: B

Solution:

To determine which hydrogen-like species will have the same radius as the 1st Bohr orbit of the hydrogen atom, we first need to recall the formula for the radius of the n th orbit in a hydrogen-like atom. The radius for the n th orbit in a hydrogen-like atom is given by:

$$r_n = \frac{n^2 h^2}{4\pi^2 m e^2 Z} \cdot \frac{1}{1}$$

where:

- r_n is the radius of the n th orbit.
- n is the principal quantum number.
- h is Planck's constant.
- m is the mass of the electron.
- e is the charge of the electron.
- Z is the atomic number of the nucleus.

For a hydrogen atom in the 1st orbit ($n = 1$, $Z = 1$), the radius is:

$$r_1 = \frac{1^2 \cdot h^2}{4\pi^2 \cdot m \cdot e^2 \cdot 1}$$

Now, for a hydrogen-like species with atomic number Z and in the n th orbit, the radius is:

$$r_n = \frac{n^2 \cdot h^2}{4\pi^2 \cdot m \cdot e^2 \cdot Z}$$

We need to find the species and quantum number n such that its radius equals the radius of the 1st Bohr orbit of hydrogen, i.e., r_1 of the hydrogen atom. This can be written as:

$$\frac{n^2 \cdot h^2}{4\pi^2 \cdot m \cdot e^2 \cdot Z} = \frac{1^2 \cdot h^2}{4\pi^2 \cdot m \cdot e^2 \cdot 1}$$

Simplifying, we get:

$$\frac{n^2}{Z} = 1$$

This gives us:

$$n^2 = Z$$

So, the species must satisfy this condition:

- For $n = 2$, $n^2 = 2^2 = 4$. So, $Z = 4$.
- For $n = 3$, $n^2 = 3^2 = 9$. So, $Z \neq 4$ (none of the options align with this condition).

Let's check if any species listed in the options have $Z = 4$ corresponding to $n = 2$:

Option B:

- $n = 2$, Be^{3+} (Beryllium has an atomic number of 4 ($Z = 4$)).

This option satisfies the condition.

Therefore, the correct answer is:

Option B

$n = 2$, Be^{3+}

Question 98

For a first order reaction with rate constant k , the slope of the plot of \log (reactant concentration) against time is

Options:

A.

$k/2.303$

B.

k

C.

$-k/2.303$

D.

$-k$

Answer: C

Solution:

To understand the slope of the plot of \log (reactant concentration) against time for a first order reaction, let's start by examining the fundamental relationship governing first order reactions:

A first order reaction can be described by the differential rate law:

$$\frac{d[A]}{dt} = -k[A]$$

where $[A]$ is the concentration of the reactant and k is the rate constant.

To solve this differential equation, we can separate variables and integrate:

$$\int \frac{1}{[A]} d[A] = -k \int dt$$

This gives us the integrated form of the first order rate law:

$$\ln[A] = -kt + C$$

where C is the integration constant that can be determined from the initial conditions. If at $t = 0$, $[A] = [A]_0$ (initial concentration of A), then:

$$\ln[A]_0 = C$$

Thus, we can rewrite the equation as:

$$\ln[A] = \ln[A]_0 - kt$$

The next step is to convert the natural logarithm to a common logarithm (base 10) using the relationship:

$$\log[A] = \frac{\ln[A]}{\ln 10}$$

This results in:

$$\log[A] = \log[A]_0 - \frac{kt}{2.303}$$

We can clearly see that this equation is in the form $y = mx + c$ where y is $\log[A]$, c is $\log[A]_0$, and the slope m is $-k/2.303$.

Therefore, the slope of the plot of \log (reactant concentration) against time for a first order reaction is:

Option C: $-k/2.303$

Question 99

Equal volumes of aqueous solution of 0.1(M)HCl and 0.2(M)H₂SO₄ are mixed. The concentration of H⁺ ions in the resulting solution is

Options:

A.

0.15 (M)

B.

0.30 (M)

C.

0.10 (M)

D.

0.25 (M)

Answer: D

Solution:

To determine the concentration of H^+ ions in the resulting solution, we need to consider the contributions of HCl and H_2SO_4 . Both provide H^+ ions but in different proportions.

First, let's break it down for each acid:

1. Hydrochloric Acid (HCl):

HCl is a strong acid that dissociates completely in water:

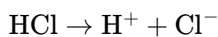

The given concentration of HCl is $0.1M$. Therefore, the concentration of H^+ ions contributed by HCl in the solution is also $0.1M$.

2. Sulfuric Acid (H_2SO_4):

H_2SO_4 is a strong acid and dissociates completely into two H^+ ions and one SO_4^{2-} ion:



The given concentration of H_2SO_4 is $0.2M$. Each mole of H_2SO_4 produces 2 moles of H^+ ions. Therefore, the concentration of H^+ ions contributed by H_2SO_4 in the solution is:

$$0.2M \times 2 = 0.4M$$

When equal volumes of the two solutions are mixed, the concentration of H^+ ions in the resulting solution is the average of the two contributions.

Hence, the overall concentration of H^+ ions in the resulting solution is:

$$\frac{0.1M + 0.4M}{2} = \frac{0.5M}{2} = 0.25M$$

Therefore, the concentration of H^+ ions in the resulting solution is $0.25M$.

Option D is the correct answer.

Question 100

The correct order of boiling point of the given aqueous solutions is

Options:

A.



B.



C.

Same for all

D.

1 N KNO_3 = 1 N NaCl = 1 N CH_3COOH > 1 N sucrose

Answer: B

Solution:

The boiling point of an aqueous solution depends on the number of solute particles in the solution. This is because the presence of solute particles causes boiling point elevation, which is a colligative property. Let's analyze the given options based on the dissociation of solutes in water:

1. **1 N KNO_3** (Potassium Nitrate): KNO_3 dissociates completely in water to form two ions: K^+ and NO_3^- . Therefore, it yields 2 particles per formula unit.
2. **1 N NaCl** (Sodium Chloride): NaCl also dissociates completely in water to form two ions: Na^+ and Cl^- . Thus, it produces 2 particles per formula unit.
3. **1 N CH_3COOH** (Acetic Acid): CH_3COOH is a weak electrolyte and does not completely dissociate in water. It partially ionizes to produce CH_3COO^- and H^+ . The number of particles produced is less than a strong electrolyte like NaCl or KNO_3 .
4. **1 N Sucrose**: Sucrose is a non-electrolyte and does not dissociate in water. It remains as one molecule and does not increase the number of particles in the solution.

Based on the above points, the order of boiling points for the given aqueous solutions is determined by the number of particles they produce in solution. More particles lead to a higher boiling point.

- 1 N KNO_3 and 1 N NaCl will have the same boiling point elevation since both produce 2 particles per formula unit.
- 1 N CH_3COOH will have a lower boiling point elevation than KNO_3 and NaCl due to partial dissociation.
- 1 N Sucrose will have the lowest boiling point elevation since it does not dissociate.

Therefore, the correct order according to boiling points is:

Option B

1 N KNO_3 = 1 N NaCl > 1 N CH_3COOH > 1 N sucrose

Question 101

Correct solubility order of AgF , AgCl , AgBr , AgI in water is

Options:

A.

$\text{AgF} < \text{AgCl} > \text{AgBr} > \text{AgI}$

B.

$\text{AgI} < \text{AgBr} < \text{AgCl} < \text{AgF}$

C.

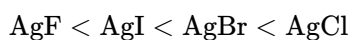

D.

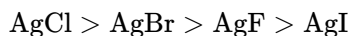

Answer: B

Solution:

The correct answer is **Option B**:

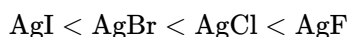

Here's why:

Solubility is the ability of a substance (solute) to dissolve in a solvent. In this case, we're looking at the solubility of silver halides (AgF, AgCl, AgBr, AgI) in water.

- **Lattice Energy:** The strength of the ionic bond in the silver halide crystal lattice plays a major role in solubility. As the size of the halide ion increases ($\text{F}^- < \text{Cl}^- < \text{Br}^- < \text{I}^-$), the lattice energy decreases. This is because the larger ions have weaker electrostatic attractions.
- **Hydration Energy:** The energy released when ions are surrounded by water molecules is called hydration energy. Smaller ions with higher charge density have stronger hydration energies.

In the case of silver halides:

- **AgF:** Fluoride ion is the smallest and has the highest charge density. It has a strong hydration energy, overcoming the relatively weak lattice energy. This makes AgF highly soluble.
- **AgCl:** Chloride ion is larger than fluoride, so the lattice energy is weaker. The hydration energy is also somewhat reduced. AgCl is less soluble than AgF.
- **AgBr:** Bromide ion is even larger, resulting in even weaker lattice energy and further reduced hydration energy. AgBr is less soluble than AgCl.
- **AgI:** Iodide ion is the largest, leading to the weakest lattice energy and the lowest hydration energy. AgI is the least soluble among the silver halides.

Therefore, the solubility order is:

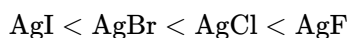

Question 102

What will be the change in acidity if

(i) CuSO_4 is added in saturated $(\text{NH}_4)_2\text{SO}_4$ solution

(ii) SbF_5 is added in anhydrous HF

Options:

A.

increase, increase

B.

decrease, decrease

C.

increase, decrease

D.

decrease, increase

Answer: A

Solution:

Let's analyze how the addition of the given compounds affects the acidity in both scenarios:

(i) CuSO_4 is added to a saturated $(\text{NH}_4)_2\text{SO}_4$ solution:

CuSO_4 is a salt that can hydrolyze in solution to form an acidic solution due to the formation of H^+ ions. Adding CuSO_4 to a saturated $(\text{NH}_4)_2\text{SO}_4$ solution will contribute additional H^+ ions, thus increasing the acidity of the solution.

(ii) SbF_5 is added to anhydrous HF:

SbF_5 is known as a Lewis acid, and when it is added to anhydrous HF (which itself is a weak acid), it forms a highly acidic superacid called fluoroantimonic acid (HSbF_6). This greatly increases the acidity of the mixture due to the high proton-donating ability of the resulting superacid.

Therefore, in both cases, the acidity will increase upon the addition of CuSO_4 and SbF_5 to the respective solutions.

Correct Option: A - increase, increase

Question 103

Which of the following contains maximum number of lone pairs on the central atom?

Options:

A.



B.



C.



D.



Answer: D

Solution:

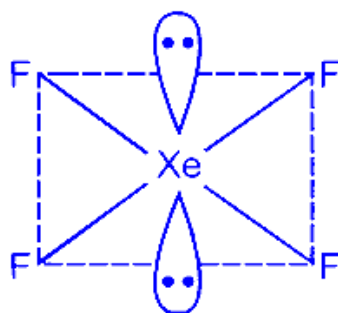

Number of l.p. = 2

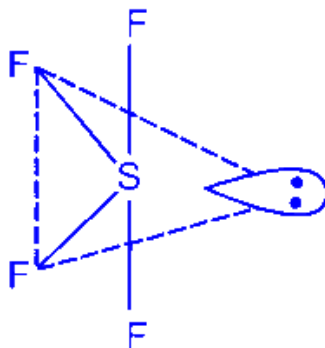

Number of l.p. = 1

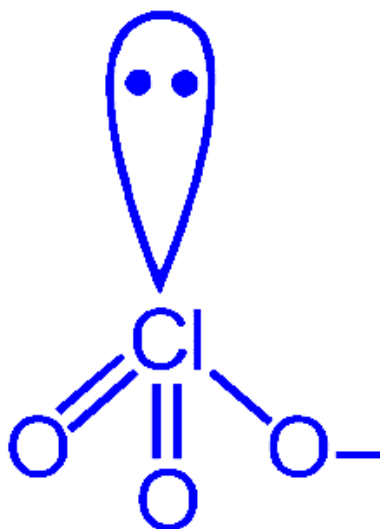

Number of l.p. = 1

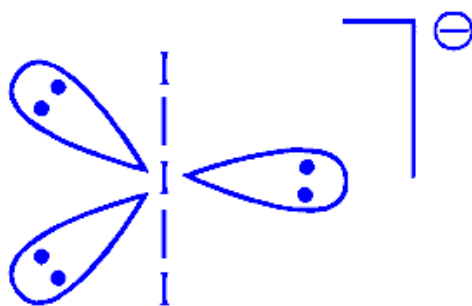

Number of l.p. = 3 (Maximum)

Question 104

Number of moles of ions produced by complete dissociation of one mole of Mohr's salt in water is

Options:

A.

3

B.

4

C.

5

D.

6

Answer: C

Solution:

To determine the number of moles of ions produced by complete dissociation of one mole of Mohr's salt in water, we first need to understand its chemical composition and how it dissociates.

Mohr's salt is a double salt with the chemical formula $\text{FeSO}_4 \cdot (\text{NH}_4)_2\text{SO}_4 \cdot 6\text{H}_2\text{O}$. When it dissociates completely in water, it produces ions from each of its constituent compounds.

The dissociation can be represented as follows:

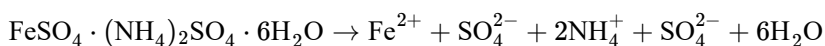

Let's break this down step by step:

1. One mole of FeSO_4 produces:

- 1 mole of Fe^{2+}
- 1 mole of SO_4^{2-}

2. One mole of $(\text{NH}_4)_2\text{SO}_4$ produces:

- 2 moles of NH_4^+
- 1 mole of SO_4^{2-}

Summing up all the ions produced, we get:

- 1 mole of Fe^{2+}
- 2 moles of SO_4^{2-}
- 2 moles of NH_4^+

Therefore total number of moles of ions produced by complete dissociation of one mole of Mohr's salt are:

$$1 + 2 + 2 = 5 \text{ moles of ions}$$

Thus, the correct answer is:

Option C: 5

Question 105

Which of the following species exhibits both LMCT and paramagnetism?

Options:

A.



B.



C.

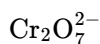

D.



Answer: A

Solution:

To determine which species exhibits both Ligand-to-Metal Charge Transfer (LMCT) and paramagnetism, we need to examine the electronic structure and bonding characteristics of each species.

Ligand-to-Metal Charge Transfer (LMCT): This occurs when an electron is transferred from a ligand orbital (usually nonbonding or occupied π orbitals) to an empty or partially filled metal d-orbital. For LMCT to occur, the metal should have accessible empty d-orbitals and the ligands must be capable of donating electrons.

Paramagnetism: A species is paramagnetic if it has one or more unpaired electrons. This can be determined using the electronic configuration of the metal center.

Let's analyze each given species:

Option A: MnO_4^{2-}

In MnO_4^{2-} , the oxidation state of Mn is +6. The electron configuration of Mn in the +6 oxidation state is $[\text{Ar}]3d^1$. It has one unpaired electron, so it is paramagnetic. However, LMCT typically involves the transfer of electrons from ligands to the metal's empty d-orbitals. Since MnO_4^{2-} is already in a high oxidation state, it is less likely to exhibit LMCT.

Option B: MnO_4^-

In MnO_4^- , the oxidation state of Mn is +7. The electron configuration of Mn in +7 oxidation state is $[\text{Ar}]3d^0$, which means there are no unpaired electrons. Therefore, it is diamagnetic. Additionally, it has empty d-orbitals, making it capable of exhibiting LMCT.

Option C: $\text{Cr}_2\text{O}_7^{2-}$

In $\text{Cr}_2\text{O}_7^{2-}$, each Cr is in the +6 oxidation state. The electron configuration of Cr in the +6 oxidation state is $[\text{Ar}]3d^0$. Like MnO_4^- , there are no unpaired electrons, so it is diamagnetic. However, it can exhibit LMCT due to the presence of empty d-orbitals.

Option D: CrO_4^{2-}

In CrO_4^{2-} , the oxidation state of Cr is +6. The electron configuration of Cr in the +6 oxidation state is also $[\text{Ar}]3d^0$. Therefore, it is diamagnetic. Similar to $\text{Cr}_2\text{O}_7^{2-}$, it can exhibit LMCT due to empty d-orbitals.

From the analysis, only MnO_4^{2-} exhibits paramagnetism (due to one unpaired electron) while also being capable of LMCT. Thus, the correct answer is:

Option A: MnO_4^{2-} .

Question 106

How many P – O – P linkages are there in P_4O_{10}

Options:

A.

Six

B.

Four

C.

Five

D.

One

Answer: A

Solution:

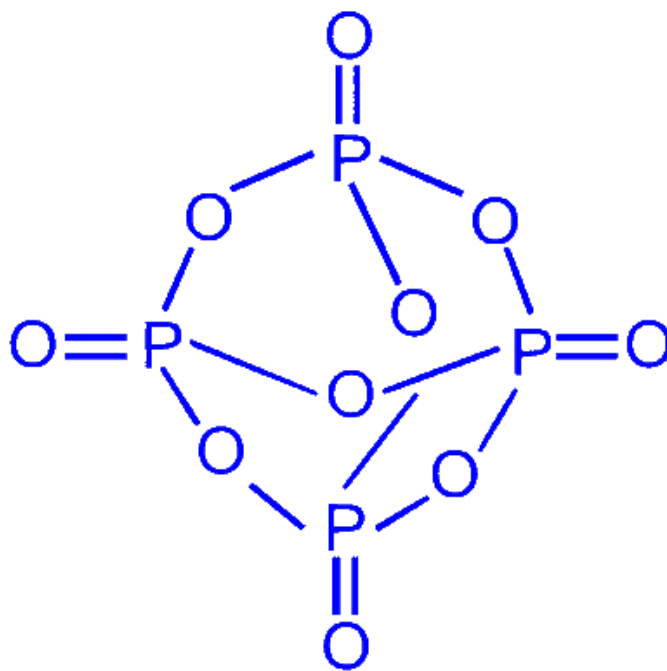

Here number of P – O – P linkages = 6

Question 107

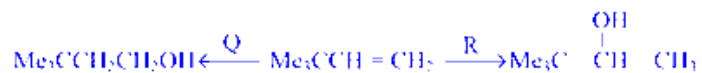

Q and R in the above reaction sequences are respectively

Options:

A.

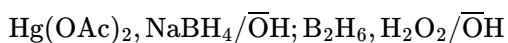

B.

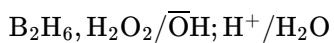

C.



D.

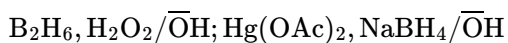

Answer: D

Solution:

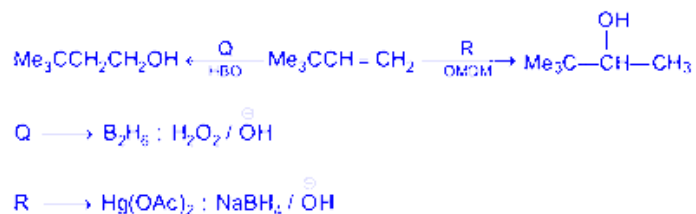

Question 108

pH of 10^{-8} (M) HCl solution is

Options:

A.

8

B.

greater than 7, less than 8

C.

greater than 8

D.

greater than 6, less than 7

Answer: D

Solution:

The calculation of pH for a diluted solution of strong acid like hydrochloric acid (HCl) requires consideration not only of the initial concentration of the acid but also the autoionization of water, which can significantly affect pH when dealing with very dilute solutions of strong acids.

HCl is a strong acid, which means it completely dissociates in water:

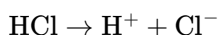

Therefore, in a solution of 10^{-8} M HCl, we would initially think the concentration of H^+ ions to also be 10^{-8} M, potentially yielding a pH of 8. However, we must also take into account the water dissociation:

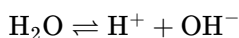

For pure water, the ion product of water (K_w) at 25°C is:

$$K_w = [\text{H}^+][\text{OH}^-] = 10^{-14}$$

In pure water, $[\text{H}^+] = [\text{OH}^-] = 10^{-7}$ M, giving a pH of 7. When we add a small amount of HCl, the initial thought would be that the hydrogen ion concentration simply increases to 10^{-8} M. However, since water itself contributes hydrogen ions and hydroxide ions of equal concentration (10^{-7} M), the total concentration of hydrogen ions becomes slightly more complicated.

Adding the hydrogen ion contributions from both the dissociation of HCl and the autoionization of water:

$$[\text{H}^+]_{\text{total}} = 10^{-7} + 10^{-8} = 1.1 \times 10^{-7} \text{M}$$

Now, calculating pH:

$$\text{pH} = -\log(1.1 \times 10^{-7})$$

To solve this, we remember that $\log(1.1) \approx 0.0414$, so:

$$\text{pH} = -\log(10^{-7}) - \log(1.1) \approx 7 - 0.0414 = 6.9586$$

Thus, the pH of a 10^{-8} M HCl solution is about 6.96, which means it is just a little lower than 7 due to the slight excess of hydrogen ions contributed by the very diluted HCl solution in combination with the hydrogen ions from autoionization of water.

The correct answer would be:

Option D: greater than 6, less than 7

Question 109

The specific conductance (κ) of 0.02(M) aqueous acetic acid solution at 298 K is $1.65 \times 10^{-4} \text{ S cm}^{-1}$. The degree of dissociation of acetic acid is

$$[\lambda_{\text{O}^{+}} = 349.1 \text{ S cm}^2 \text{ mol}^{-1} \text{ and } \lambda_{\text{CH}_3\text{COO}^{-}} = 40.9 \text{ S cm}^2 \text{ mol}^{-1}]$$

Options:

A.

0.021

B.

0.21

C.

0.012

D.

0.12

Answer: A

Solution:

To find the degree of dissociation of the acetic acid, we first need to calculate the molar conductivity (Λ_m) of the solution. The formula for molar conductivity is:

$$\Lambda_m = \frac{\kappa}{c}$$

where:

- κ (kappa) is the specific conductance.
- c is the concentration of the acetic acid solution.

Given:

- $\kappa = 1.65 \times 10^{-4} \text{ S cm}^{-1}$
- $c = 0.02 \text{ M}$

Substituting these values into the formula for molar conductivity:

$$\Lambda_m = \frac{1.65 \times 10^{-4}}{0.02}$$

Calculating this gives:

$$\Lambda_m = 8.25 \times 10^{-3} \text{ S cm}^2 \text{ mol}^{-1}$$

Next, we need to find the limiting molar conductivity (Λ_m^0) of acetic acid, which is the sum of the limiting molar conductivities of its ions:

$$\Lambda_m^0 = \lambda_{\text{O}^+}^{\circ} + \lambda_{\text{CH}_3\text{COO}^-}^{\circ}$$

Given:

- $\lambda_{\text{O}^+}^{\circ} = 349.1 \text{ S cm}^2 \text{ mol}^{-1}$
- $\lambda_{\text{CH}_3\text{COO}^-}^{\circ} = 40.9 \text{ S cm}^2 \text{ mol}^{-1}$

Calculating the limiting molar conductivity:

$$\Lambda_m^0 = 349.1 + 40.9 = 390 \text{ S cm}^2 \text{ mol}^{-1}$$

The degree of dissociation (α) can now be determined using the ratio of the molar conductivity to the limiting molar conductivity:

$$\alpha = \frac{\Lambda_m}{\Lambda_m^0}$$

Substituting the values we calculated:

$$\alpha = \frac{8.25 \times 10^{-3}}{390}$$

Calculating this gives:

$$\alpha = 2.115 \times 10^{-5} \approx 0.021$$

The degree of dissociation of the acetic acid is approximately 0.021. Hence, the correct option is:

Option A

Question 110

The number(s) of –OH group(s) present in H_3PO_3 and H_3PO_4 is/are

Options:

A.

3 and 3 respectively

B.

3 and 4 respectively

C.

2 and 3 respectively

D.

1 and 3 respectively

Answer: C

Solution:

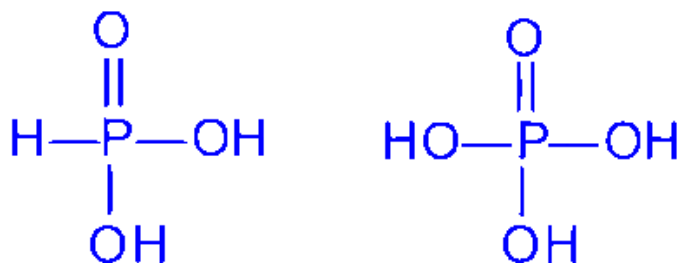

Question 111

Which of the following statements about the S_N2 reaction mechanism is/are true?

Options:

A.

The rate of reaction increases with increasing nucleophilicity.

B.

The number 2 denotes a second order reaction.

C.

Tertiary butyl substrates do not follow this mechanism.

D.

The optical rotation of substrates always changes from (+) to (−) or from (−) to (+) in the products.

Answer: A

Solution:

The correct statements about the S_N2 reaction mechanism are :

Option A : The rate of reaction increases with increasing nucleophilicity.

This statement is true. In an S_N2 reaction, the nucleophile attacks the electrophilic carbon in a single, concerted step. Therefore, a stronger (more nucleophilic) nucleophile will generally result in a faster reaction because it can more readily attack the carbon center.

Option B : The number 2 denotes a second order reaction.

This statement is also true. The term S_N2 stands for bimolecular nucleophilic substitution and indicates that the rate-determining step involves two reacting species: the nucleophile and the electrophilic substrate. The rate law for an S_N2 reaction is given by:

$$\text{Rate} = k[\text{Nucleophile}][\text{Electrophile}]$$

This indicates that the reaction is second order overall.

Option C : Tertiary butyl substrates do not follow this mechanism.

This statement is true. Tertiary butyl substrates are typically very sterically hindered, making it difficult for the nucleophile to approach the electrophilic carbon from the backside, which is required for the S_N2 mechanism. As a result, tertiary substrates usually do not undergo S_N2 reactions.

Option D : The optical rotation of substrates always changes from (+) to (-) or from (-) to (+) in the products.

This statement is incorrect because in an S_N2 reaction inversion does take place but we can never say a dextro substrate will produce a levo product or vice-versa. Because the dextro or levo nature of the reactant or product are purely experimental.

Question 112

Which of the following represent(s) the enantiomer of Y ?

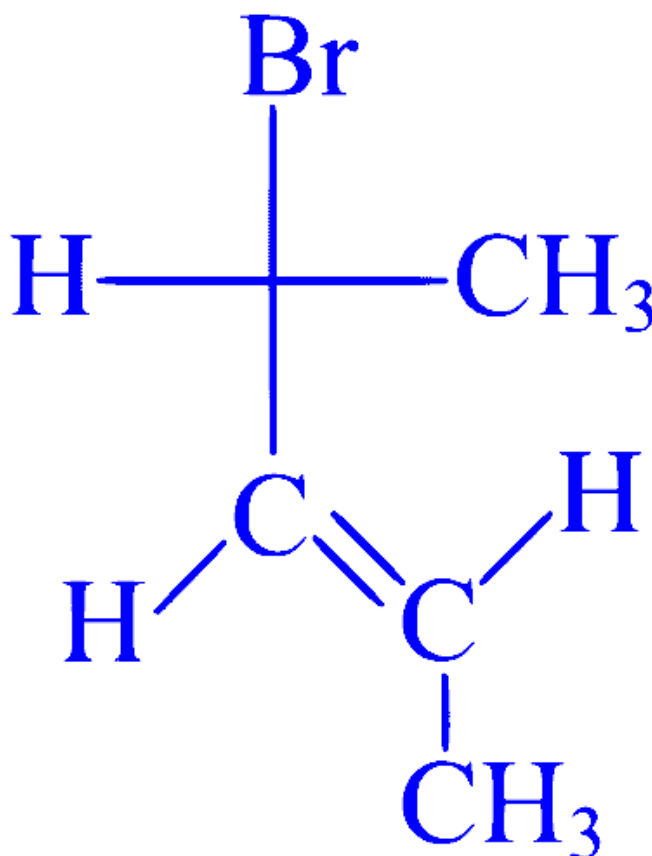

(Y)

Options:

A.

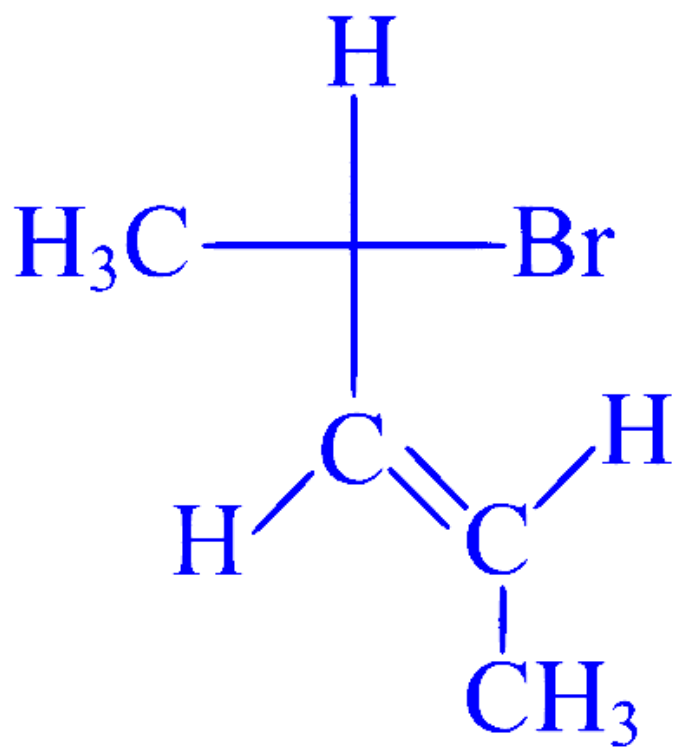

B.

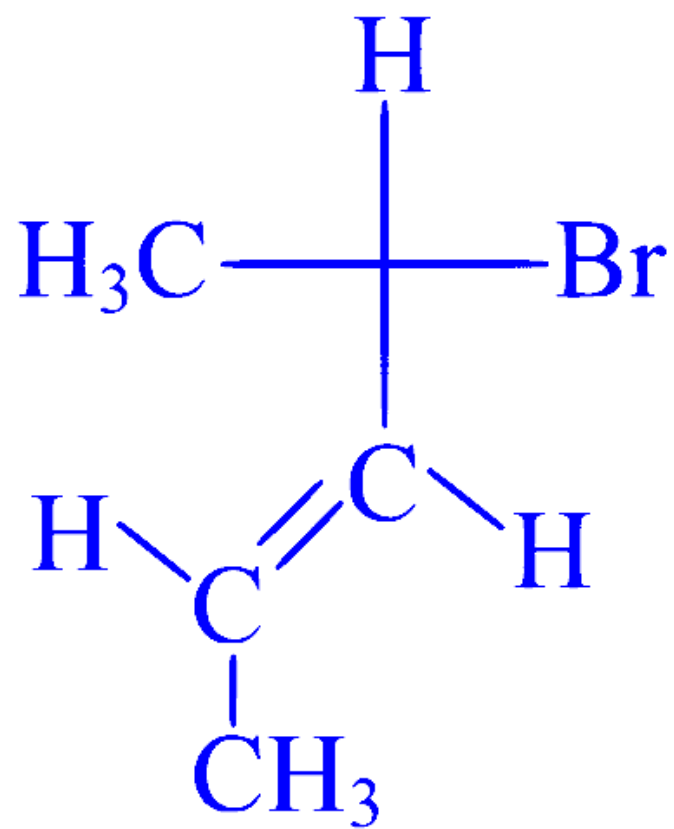

C.

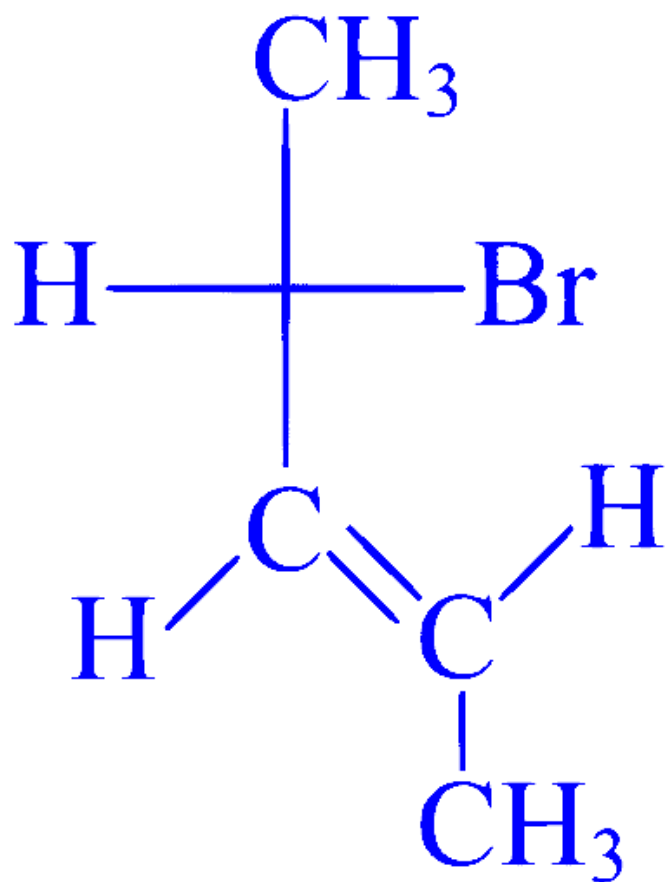

D.

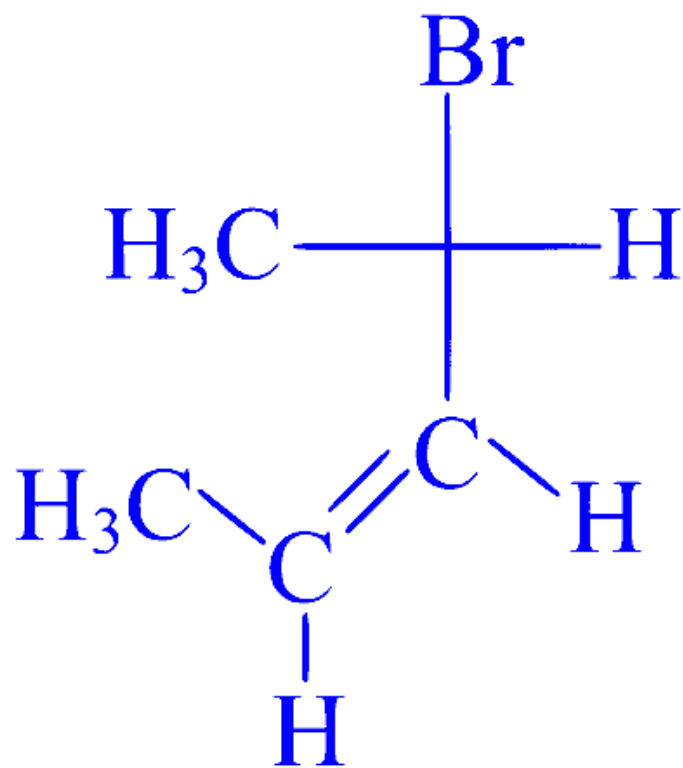

Answer: B

Solution:

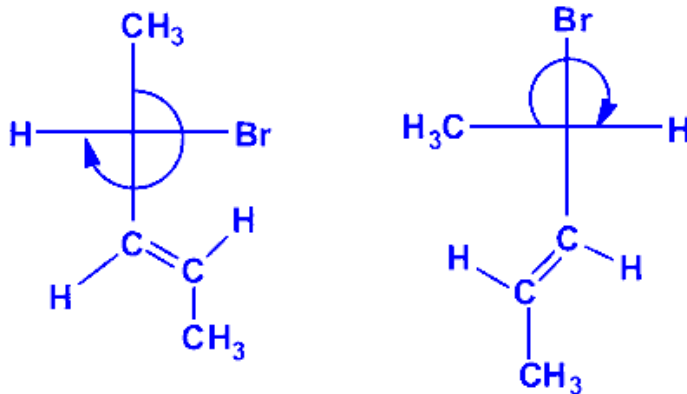

Both the compounds given in option (B) and (C) are with opposite configuration of the chiral carbon and with same (E) configuration of the double bond. So, they are enantiomeric to given compound Y.

Question 113

Identify the correct statement(s) :

Options:

A.

The oxidation number of Cr in CrO_5 is +6

B.

$\Delta H > \Delta U$ for the reaction $\text{N}_2\text{O}_4(\text{g}) \rightarrow 2\text{NO}_2(\text{g})$, provided both gases behave ideally

C.

pH of 0.1(N) H_2SO_4 is less than that of 0.1(N) HCl at 25°C

D.

$\left(\frac{RT}{F}\right) = 0.0591$ volt at 25°C

Answer: A

Solution:

Let's analyze each of the given statements one by one:

Option A: The oxidation number of Cr in CrO_5 is +6.

To determine the oxidation state of Cr in CrO_5 , we need to know the structure of CrO_5 . The compound CrO_5 has a peroxide linkage.

Let's calculate the oxidation state:

- The oxidation state of O in peroxides (O_2^{2-}) is -1.
- For the other two oxygens (not in peroxides), the oxidation state is -2 each.

Let the oxidation state of Cr in CrO_5 be x :

$$x + 2(-1) + 2(-2) = 0$$

Solving for x :

$$x - 2 - 4 = 0$$

$$x = 6$$

Thus, the oxidation state of Cr is indeed +6. Option A is correct.

Option B: $\Delta H > \Delta U$ for the reaction $N_2O_4(g) \rightarrow 2NO_2(g)$, provided both gases behave ideally.

We use the relation:

$$\Delta H = \Delta U + \Delta nRT$$

Here, Δn is the change in the number of moles of gases. For the reaction:

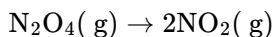

$\Delta n = 2 - 1 = 1$. Since Δn is positive, we have:

$$\Delta H = \Delta U + \Delta nRT$$

This implies:

$$\Delta H > \Delta U$$

Hence, Option B is correct.

Option C: pH of 0.1(N) H_2SO_4 is less than that of 0.1(N) HCl at $25^\circ C$.

Option (C) is incorrect because 0.1(N) H_2SO_4 furnishes less H^+ ion than 0.1(N) HCl, So, pH of the former solution will be more than the later.

Option D: $\left(\frac{RT}{F}\right) = 0.0591$ volt at $25^\circ C$.

Let's calculate $\left(\frac{RT}{F}\right)$ at $25^\circ C$:

- $R = 8.314 \text{ J/mol}\cdot\text{K}$
- $T = 298 \text{ K } (25^\circ C)$
- $F = 96485 \text{ C/mol}$

So:

$$\left(\frac{RT}{F}\right) = \frac{8.314 \times 298}{96485}$$

On calculation:

$$\left(\frac{RT}{F}\right) \approx 0.0257 \text{ V}$$

This value is not 0.0591 V. Thus, Option D is incorrect.

Summarizing, the correct statements are **Option A** and **Option B**.

Question 114

Which of the following ion/ions is/are diamagnetic ?

Options:

A.

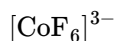

B.



C.

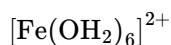

D.



Answer: B

Solution:

To determine which of the given ions are diamagnetic, we need to look at their electronic configurations and the nature of the ligands involved. A diamagnetic substance is one that has all of its electrons paired.

Let's analyze each option one by one:

Option A: $[\text{CoF}_6]^{3-}$

- Here, the central ion is Co^{3+} .
- Cobalt's atomic number is 27, so Co^{3+} has 24 electrons.
- The electron configuration of Co^{3+} is given by removing 3 electrons from Co: $[\text{Ar}]3d^6$.
- Fluoride (F^-) is a weak field ligand, meaning it does not cause a large split in the d-orbitals.
- In a weak field, the electron configuration remains as it is without pairing up, thus: $t_{2g}^4 e_g^2$.
- Since there are unpaired electrons, the ion $[\text{CoF}_6]^{3-}$ is paramagnetic.

Option B: $[\text{Co}(\text{NH}_3)_6]^{3+}$

- The central ion here is also Co^{3+} .
- Similarly, Co^{3+} : $[\text{Ar}]3d^6$.
- Ammonia (NH_3) is a strong field ligand, causing a large split in the d-orbitals which leads to pairing of electrons.
- In a strong field, the electron configuration can be rearranged to pair up electrons: $t_{2g}^6 e_g^0$.

- All electrons are paired.
- Therefore, the ion $[\text{Co}(\text{NH}_3)_6]^{3+}$ is diamagnetic.

Option C: $[\text{Fe}(\text{OH}_2)_6]^{2+}$

- The central ion is Fe^{2+} .
- Iron's atomic number is 26, so Fe^{2+} has 24 electrons.
- The electron configuration of Fe^{2+} is $[\text{Ar}]3d^6$.
- Water (H_2O) is a weak field ligand, similarly not causing a large split.
- In a weak field, the electron configuration remains: $t_{2g}^4 e_g^2$ with unpaired electrons.
- Therefore, the ion $[\text{Fe}(\text{OH}_2)_6]^{2+}$ is paramagnetic.

Option D: $[\text{Fe}(\text{CN})_6]^{4-}$

- For Fe^{2+} in $[\text{Fe}(\text{CN})_6]^{4-}$.
- The electron configuration of Fe^{2+} remains $[\text{Ar}]3d^6$.
- Cyanide (CN^-) is a very strong field ligand, causing a large split leading to pairing.
- In a strong field situation: $t_{2g}^6 e_g^0$ with paired electrons.
- Therefore, the ion $[\text{Fe}(\text{CN})_6]^{4-}$ is diamagnetic.

Therefore, the diamagnetic ions among the given options are:

- Option B: $[\text{Co}(\text{NH}_3)_6]^{3+}$
- Option D: $[\text{Fe}(\text{CN})_6]^{4-}$

Question 115

Which of the following statement/statements is/are correct ?

Options:

A.

Solid I_2 is freely soluble in water

B.

Solid I_2 is freely soluble in water but only in presence of excess KI

C.

Solid I_2 is freely soluble in CCl_4

D.

Solid I_2 is freely soluble in hot water

Answer: B

Solution:

Let's analyze each option to determine its correctness:

Option A: Solid I_2 is freely soluble in water

This statement is incorrect. Iodine (I_2) is only slightly soluble in water. It does not dissolve freely due to its non-polar nature, which does not interact well with polar solvent molecules like water.

Option B: Solid I_2 is freely soluble in water but only in presence of excess KI

This statement is correct. When KI (potassium iodide) is present in excess, iodine forms a soluble complex, KI_3 (potassium triiodide), which is much more soluble in water. The excess iodide ions from KI react with iodine:

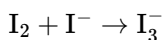

The triiodide ion I_3^- is soluble in water.

Option C: Solid I_2 is freely soluble in CCl_4

This statement is correct. Iodine (I_2) is non-polar and thus dissolves well in non-polar solvents such as carbon tetrachloride (CCl_4). The similar polarity allows I_2 to dissolve freely in CCl_4 .

Option D: Solid I_2 is freely soluble in hot water

This statement is incorrect. While solubility of substances generally increases with temperature, iodine remains only slightly more soluble in hot water than in cold water. It does not become "freely soluble" in hot water due to its inherent non-polar nature.

Therefore, the correct statements are:

Option B and Option C.

Physics

Question 116

Let θ be the angle between two vectors \vec{A} and \vec{B} . If \hat{a}_\perp is the unit vector perpendicular to \vec{A} , then the direction of $\vec{B} - B \sin \theta \hat{a}_\perp$ is

Options:

A.

along \vec{B}

B.

perpendicular \vec{B}

C.

along \vec{A}

D.

perpendicular \vec{A}

Answer: C

Solution:

To determine the direction of the vector expression

$\vec{B} - B \sin \theta \hat{a}_\perp$, let's break it down step-by-step:

1. Understanding the given vectors:

Let \vec{A} and \vec{B} be two vectors with an angle θ between them. The unit vector \hat{a}_\perp is perpendicular to \vec{A} .

2. Projection of \vec{B} :

The term $B \sin \theta$ is equivalent to the magnitude of the component of \vec{B} that is perpendicular to \vec{A} . Thus, multiplying it with \hat{a}_\perp gives a vector component of \vec{B} perpendicular to \vec{A} , which can be written as:

$B \sin \theta \hat{a}_\perp$

3. Subtracting the perpendicular component from \vec{B} :

When we subtract this perpendicular component from \vec{B} , we get:

$$\vec{B} - B \sin \theta \hat{a}_\perp$$

This operation essentially removes the part of \vec{B} that is perpendicular to \vec{A} , leaving only the component of \vec{B} that is parallel to \vec{A} .

4. Conclusion:

The resulting vector will be pointing in the direction along \vec{A} because the perpendicular component has been removed. Thus, the direction of

$$\vec{B} - B \sin \theta \hat{a}_\perp \text{ is along } \vec{A}.$$

Therefore, the correct answer is:

Option C: along \vec{A} .

Question 117

The Power (P) radiated from an accelerated charged particle is given by

$P \propto \frac{(qa)^m}{c^n}$ where q is the charge, a is the acceleration of the particle and c is speed of light in vacuum. From dimensional analysis, the value of m and n respectively, are

Options:

A.

$$m = 2, n = 2$$

B.

$$m = 2, n = 3$$

C.

$$m = 3, n = 2$$

D.

$$m = 0, n = 1$$

Answer: B

Solution:

To find the values of m and n through dimensional analysis, we must ensure that the dimensions on both sides of the proportionality equation are the same. The fundamental dimensions involved here are mass (M), length (L), and time (T).

Let's start with the dimensional analysis of each quantity:

The power P has the dimensions of energy per unit time, which is:

$$[P] = [ML^2T^{-3}]$$

The charge q has the dimensions of electric current (I) times time (T), giving us:

$$[q] = [IT]$$

The acceleration a is the change in velocity per unit time, where velocity (v) has dimensions of length per unit time:

$$[a] = [LT^{-2}]$$

The speed of light c has the dimensions of velocity, which are:

$$[c] = [LT^{-1}]$$

Given the proportionality relationship:

$$P \propto \frac{(qa)^m}{c^n}$$

The dimensions of the right-hand side are:

$$\left[\frac{(qa)^m}{c^n} \right] = \left[\frac{(IT \cdot LT^{-2})^m}{(LT^{-1})^n} \right]$$

Simplifying further:

$$\left[\frac{(IT \cdot LT^{-2})^m}{L^n T^{-n}} \right] = \left[\frac{(ILT^{-1})^m}{L^n T^{-n}} \right]$$

Combining the powers:

$$\left[\frac{\mathbf{I}^m \mathbf{L}^m \mathbf{T}^{-m}}{\mathbf{L}^n \mathbf{T}^{-n}} \right] = [\mathbf{I}^m \mathbf{L}^{m-n} \mathbf{T}^{-m+n}]$$

We want this to match the dimensions of power:

$$[\mathbf{ML}^2 \mathbf{T}^{-3}]$$

Therefore, we equate the dimensions of each term on both sides:

For the current (**I**):

$$m = 0 \quad (\text{since there is no current dimension in the power})$$

For the length (**L**):

$$m - n = 2$$

For the time (**T**):

$$-m + n = -3$$

Now, we solve these two simultaneous equations:

$$1. \quad m - n = 2$$

$$2. \quad -m + n = -3$$

Adding these two equations:

$$(m - n) + (-m + n) = 2 - 3$$

$$0 = -1$$

So we have:

$$m - n = 2$$

$$-m + n = -3$$

Solving these, we get:

$$m = 2$$

$$n = 3$$

Thus, the correct values are:

Option B

$$m = 2, n = 3$$

Question 118

Two convex lens (L_1 and L_2) of equal focal length f are placed at a distance $\frac{f}{2}$ apart. An object is placed at a distance $4f$ in the left of L_1 as shown in figure. The final image is at

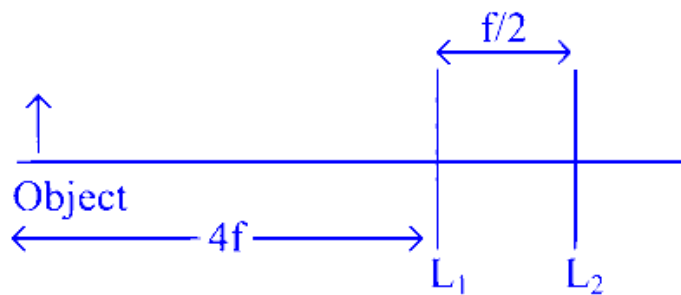

Options:

A.

$\frac{5f}{11}$ right of L_2

B.

$\frac{5f}{11}$ left of L_2

C.

5f right of L_2

D.

5f left of L_2

Answer: A

Solution:

$$L_1 : \frac{1}{v} - \frac{1}{-4f} = \frac{1}{f}$$

$$\frac{1}{v} = \frac{1}{f} - \frac{1}{4f} = \frac{4-1}{4f}$$

$$v = \frac{4f}{3}$$

$$L_2 : u = \frac{4f}{3} - \frac{f}{2} = \frac{8f-3f}{6} = \frac{5f}{6}$$

$$\frac{1}{v} - \frac{1}{u} = \frac{1}{f}$$

$$\frac{1}{v} - \frac{6}{5f} = \frac{1}{f}$$

$$\frac{1}{v} = \frac{1}{f} + \frac{6}{5f} = \frac{5+6}{5f}$$

$$v = \frac{5f}{11} \Rightarrow \text{right side of } L_2$$

Question 119

Which of the following quantity has the dimension of length ?

(h is Planck's constant, m is the mass of electron and c is the velocity of light)

Options:

A.

$$\frac{hc}{m}$$

B.

$$\frac{h}{mc^2}$$

C.

$$\frac{h^2}{mc^2}$$

D.

$$\frac{h}{mc}$$

Answer: D

Solution:

To determine which quantity has the dimension of length, we need to analyze the dimensions of each option provided. We have:

- h as Planck's constant
- m as the mass of the electron
- c as the velocity of light

First, we need to recall the dimensions of these constants:

- Planck's constant (h) has the dimension of action, which is energy multiplied by time:

$$[h] = [E][T]$$

where $[E]$ is the dimension of energy and $[T]$ is the dimension of time.

- The dimension of energy (E) is given by $[E] = [M][L]^2/[T]^2$, where $[M]$ is mass, $[L]$ is length, and $[T]$ is time.
- The dimension of mass (m) is simply $[M]$.
- The dimension of the velocity of light (c) is $[c] = [L]/[T]$.

We can calculate the dimensions for each option:

Option A:

$$\frac{hc}{m}$$

Substituting the known dimensions:

$$\left[\frac{hc}{m}\right] = \frac{[E][T][L]/[T]}{[M]} = \frac{[M][L]^2/[T]^2[L]/[T]}{[M]} = [L]^3$$

Option B:

$$\frac{h}{mc^2}$$

Substituting the known dimensions:

$$\left[\frac{h}{mc^2}\right] = \frac{[E][T]}{[M][L]^2/[T]^2} = \frac{[M][L]^2/[T]^2[T]}{[M][L]^2/[T]^2} = [T] = [1/c]^{-1}[L]$$

Option C:

$$\frac{h^2}{mc^2}$$

Substituting the known dimensions:

$$\left[\frac{h^2}{mc^2}\right] = \frac{([E][T])^2}{[M][L]^2/[T]^2} = \frac{[M]^2[L]^4/[T]^4[T]^2}{[M][L]^2/[T]^2} = [M][L]^2$$

Option D:

$$\frac{h}{mc}$$

Substituting the known dimensions:

$$\left[\frac{h}{mc}\right] = \frac{[E][T]}{[M][L]/[T]} = \frac{[M][L]^2/[T]^2[T]}{[M][L]/[T]} = [L]$$

Thus, the quantity that has the dimension of length is Option D:

$$\frac{h}{mc}$$

Question 120

The speed distribution for a sample of N gas particles is shown below. $P(v) = 0$ for $v > 2v_0$. How many particles have speeds between $1.2v_0$ and $1.8v_0$?

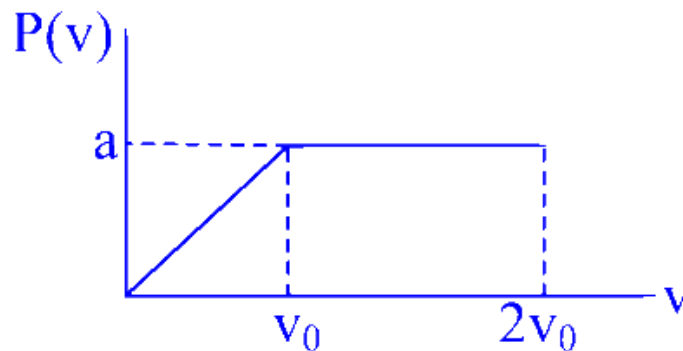

Options:

A.

0.2 N

B.

0.4 N

C.

0.6 N

D.

0.8 N

Answer: B

Solution:

$$\text{Favourable space} = \int_{1.2v_0}^{1.8v_0} P dv$$

$$= a \times 0.6v_0$$

$$\text{Sample space} = \int_0^{\infty} P dv$$

$$= \text{Area}$$

$$= \frac{1}{2}v_0a + (2v_0 - v_0)a$$

$$= 1.5av_0$$

$$\frac{n}{N} = \frac{0.6}{1.6} = \frac{2}{5}$$

$$n = \frac{2}{5}N = 0.4 N$$

Question 121

The internal energy of a thermodynamic system is given by $U = as^{4/3}V^\alpha$ where s is entropy, V is volume and 'a' and ' α ' are constants. The value of α is

Options:

A.

1

B.

-1

C.

$\frac{1}{3}$

D.

$$-\frac{1}{3}$$

Answer: D

Solution:

We know that for a system, the internal energy (U) is a function of entropy (S) and volume (V). We can write this as:

$$dU = TdS - PdV$$

Where:

- T is the temperature
- P is the pressure

Now, let's differentiate the given expression for internal energy:

$$dU = \frac{4}{3}as^{1/3}V^\alpha dS + a\alpha s^{4/3}V^{\alpha-1}dV$$

Comparing the coefficients of dS and dV in both expressions, we get:

$$T = \frac{4}{3}as^{1/3}V^\alpha$$

$$P = -a\alpha s^{4/3}V^{\alpha-1}$$

Now, let's find the relation between T, P, V, and S using the following thermodynamic relations:

$$T = \left(\frac{\partial U}{\partial S}\right)_V$$

$$P = -\left(\frac{\partial U}{\partial V}\right)_S$$

From the expression for T, we have:

$$T = \frac{4}{3}as^{1/3}V^\alpha$$

From the expression for P, we have:

$$P = -a\alpha s^{4/3}V^{\alpha-1}$$

Now, let's substitute the expressions for T and P into the relation $T = \left(\frac{\partial U}{\partial S}\right)_V$ and $P = -\left(\frac{\partial U}{\partial V}\right)_S$:

For $T = \left(\frac{\partial U}{\partial S}\right)_V$:

$$\frac{4}{3}as^{1/3}V^\alpha = \frac{4}{3}as^{1/3}V^\alpha$$

For $P = -\left(\frac{\partial U}{\partial V}\right)_S$:

$$-a\alpha s^{4/3}V^{\alpha-1} = -a\alpha s^{4/3}V^{\alpha-1}$$

We can see that both equations are consistent. Therefore, the value of α can be any number. However, in the context of thermodynamics, the internal energy is often expressed as a function of entropy and volume, where the exponent of volume is often -1/3. This leads to the following expression for internal energy:

$$U = as^{4/3}V^{-1/3}$$

Therefore, the correct answer is **D**. $-\frac{1}{3}$

Question 122

A particle of mass ' m ' moves in one dimension under the action of a conservative force whose potential energy has the form of $U(x) = -\frac{\alpha x}{x^2 + \beta^2}$ where α and β are dimensional parameters. The angular frequency of the oscillation is proportional to

Options:

A.

$$\sqrt{\frac{\alpha^3}{m\beta^4}}$$

B.

$$\sqrt{\frac{\alpha}{m\beta^4}}$$

C.

$$\sqrt{\frac{\alpha}{m\beta^3}}$$

D.

$$\sqrt{\frac{\alpha}{m\beta^6}}$$

Answer: C

Solution:

To determine the angular frequency of the oscillation of a particle under the given potential energy function, we first need to find the effective force acting on the particle by taking the negative gradient of the potential energy:

$$F(x) = -\frac{dU(x)}{dx}$$

Given the potential energy function:

$$U(x) = -\frac{\alpha x}{x^2 + \beta^2}$$

we can compute the force as follows:

$$F(x) = -\frac{d}{dx} \left(-\frac{\alpha x}{x^2 + \beta^2} \right)$$

Performing the differentiation using the quotient rule for $\frac{u}{v}$, where $u = \alpha x$ and $v = x^2 + \beta^2$:

$$\frac{d}{dx} \left(\frac{\alpha x}{x^2 + \beta^2} \right) = \frac{(\alpha)(x^2 + \beta^2) - (\alpha x)(2x)}{(x^2 + \beta^2)^2}$$

Simplifying the numerator:

$$\alpha x^2 + \alpha \beta^2 - 2\alpha x^2 = \alpha \beta^2 - \alpha x^2$$

So the force is:

$$F(x) = -\frac{\alpha \beta^2 - \alpha x^2}{(x^2 + \beta^2)^2}$$

In simple harmonic motion, near the equilibrium position at $x = 0$, the potential energy function can be approximated as a quadratic function of x . That is:

$$U(x) \approx \frac{1}{2} k x^2$$

where k is the effective spring constant. The force near the equilibrium can also be approximated as:

$$F(x) \approx -kx$$

Here, we can determine k by comparing the second derivative of the potential energy function at $x = 0$.

Taking the second derivative of $U(x)$ with respect to x :

$$\frac{d^2 U(x)}{dx^2} = \frac{d}{dx} \left(\frac{dU(x)}{dx} \right)$$

We previously found the first derivative as:

$$\frac{dU(x)}{dx} = \frac{\alpha \beta^2 - \alpha x^2}{(x^2 + \beta^2)^2}$$

Evaluating the second derivative at $x = 0$:

$$\frac{d^2U(x)}{dx^2} \Big|_{x=0} = \frac{d}{dx} \left(\frac{\alpha\beta^2}{(\beta^2)^2} \right) \Big|_{x=0}$$

Since the potential energy is symmetric around $x = 0$ and the first derivative at $x = 0$ is zero, we get:

$$\frac{d^2U(x)}{dx^2} \Big|_{x=0} = \frac{d}{dx} \left(\frac{\alpha}{\beta^2} \right) \Big|_{x=0}$$

So, the effective spring constant k is:

$$k = \frac{\alpha}{\beta^2}$$

The angular frequency ω of the oscillation for a mass m attached to a spring constant k is given by:

$$\omega = \sqrt{\frac{k}{m}}$$

Substituting the value of k :

$$\omega = \sqrt{\frac{\alpha}{m\beta^2}}$$

This shows that the angular frequency is proportional to:

$$\sqrt{\frac{\alpha}{m\beta^3}}$$

Thus, the correct option is:

Option C: $\sqrt{\frac{\alpha}{m\beta^3}}$

Question 123

Longitudinal waves cannot

Options:

A.

have a unique wave length

B.

have a unique wave velocity

C.

transmit energy

D.

be polarized

Answer: D

Solution:

To determine which of the options is correct, it helps to understand the properties of longitudinal waves. Longitudinal waves are waves in which the particle displacement is parallel to the direction of wave propagation. Sound waves in air are a common example of longitudinal waves.

Let's analyze each option:

Option A: Have a unique wavelength

Longitudinal waves, like any other type of waves, have a wavelength which is the distance between successive compressions or rarefactions. Therefore, longitudinal waves can have a unique wavelength.

Option B: Have a unique wave velocity

The wave velocity in a longitudinal wave is determined by the medium in which the wave is traveling. If the medium is uniform, the wave will have a unique velocity. Therefore, longitudinal waves can have a unique wave velocity.

Option C: Transmit energy

Waves, in general, transmit energy through the medium. This is true for both longitudinal and transverse waves. Longitudinal waves can transmit energy.

Option D: Be polarized

Polarization refers to the orientation of the oscillations in a wave. Only transverse waves can be polarized because their oscillations are perpendicular to the direction of wave propagation. Since the oscillations in longitudinal waves are parallel to the direction of wave propagation, they cannot be polarized.

Therefore, the correct answer is:

Option D: Be polarized

Question 124

A 2 V cell is connected across the points A and B as shown in the figure. Assume that the resistance of each diode is zero in forward bias and infinity in reverse bias. The current supplied by the cell is

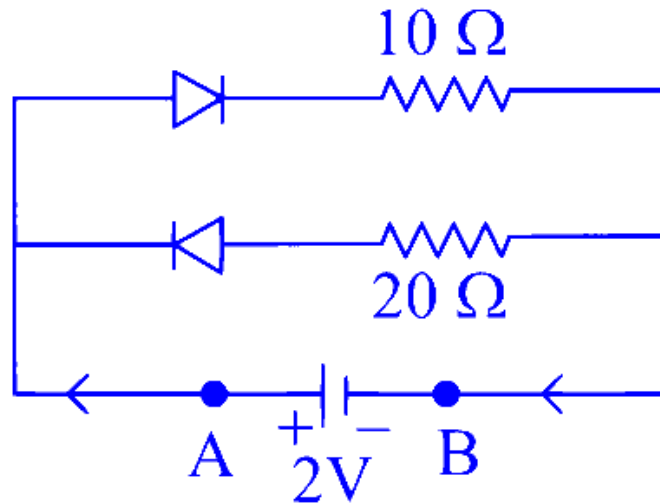

Options:

- A.
0.5 A
- B.
0.2 A
- C.
0.1 A
- D.
0.25 A

Answer: B

Solution:

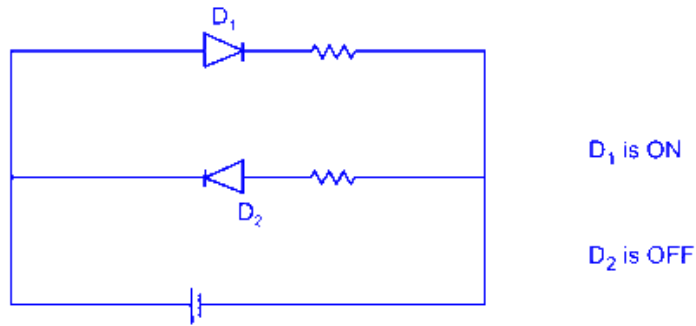

$$I = \frac{2}{10} = 0.2 \text{ A}$$

Question 125

A charge Q is placed at the centre of a cube of sides a . The total flux of electric field through the six surfaces of the cube is

Options:

A.

$$\frac{6Qa^2}{\epsilon_0}$$

B.

$$\frac{Qa^2}{6\epsilon_0}$$

C.

$$Q/\epsilon_0$$

D.

$$Qa^2/\epsilon_0$$

Answer: C

Solution:

To find the total flux of the electric field through the six surfaces of the cube, we can use Gauss's Law. Gauss's Law states that the total electric flux through a closed surface is proportional to the charge enclosed within that surface. Mathematically, it is expressed as:

$$\Phi_E = \frac{Q_{\text{enc}}}{\epsilon_0}$$

where:

- Φ_E is the electric flux
- Q_{enc} is the charge enclosed within the surface
- ϵ_0 is the permittivity of free space

In this scenario, the charge Q is placed at the center of the cube. The cube is a closed surface, and according to Gauss's Law, the total flux through this surface only depends on the enclosed charge Q and not on the dimensions of the cube.

Therefore, the total flux Φ_E through the six surfaces of the cube is:

$$\Phi_E = \frac{Q}{\epsilon_0}$$

So, the correct answer is:

Option C

$$Q/\epsilon_0$$

Question 126

The elastic potential energy of a strained body is

Options:

A.

stress \times strain

B.

stress / strain

C.

stress \times strain / volume

D.

$\frac{1}{2} \times$ stress \times strain \times volume

Answer: D

Solution:

The elastic potential energy stored in a strained body can be derived from the relationship between stress, strain, and the deformation energy per unit volume. This relationship is often represented using the formula for the elastic potential energy density in a material. The correct option is:

Option D: $\frac{1}{2} \times$ stress \times strain \times volume

Explanation:

Elastic potential energy is the energy stored in an object when it is deformed but not permanently. When a material follows Hooke's Law, the stress (force per unit area) and strain (deformation per unit length) are linearly related. The formula for elastic potential energy U in a body is given by:

$$U = \frac{1}{2} \times \text{stress} \times \text{strain} \times \text{volume}$$

Where:

- Stress is the internal force per unit area within the material.

- Strain is the relative deformation, i.e., the change in length divided by the original length.
- Volume is the measure of the space occupied by the body where the deformation occurs.

The factor $\frac{1}{2}$ comes from the integration of the linear stress-strain relationship, considering that stress increases linearly with strain from 0 to its maximum value. Thus, the correct representation of the elastic potential energy is given by Option D.

Question 127

Which of the following statement(s) is/are true in respect of nuclear binding energy ?

(i) The mass energy of a nucleus is larger than the total mass energy of its individual protons and neutrons.

(ii) If a nucleus could be separated into its nucleons, an energy equal to the binding energy would have to be transferred to the particles during the separating process.

(iii) The binding energy is a measure of how well the nucleons in a nucleus are held together.

(iv) The nuclear fission is somehow related to acquiring higher binding energy.

Options:

A.

Statements (i), (ii) and (iii) are true

B.

Statements (ii), (iii) and (iv) are true

C.

Statements (ii) and (iii) are true

D.

All the four statements are true

Answer: B

Solution:

Let's analyze each of the statements in detail to determine their correctness in respect to nuclear binding energy.

(i) The mass energy of a nucleus is larger than the total mass energy of its individual protons and neutrons.

This statement is actually false. Due to the binding energy, the mass of a nucleus is less than the sum of the masses of its individual protons and neutrons. This difference in mass is converted into binding energy, which is given by Einstein's mass-energy equivalence principle: $E = mc^2$. Therefore, the mass energy of a nucleus is smaller, not larger, than the total mass energy of its constituent nucleons.

(ii) If a nucleus could be separated into its nucleons, an energy equal to the binding energy would have to be transferred to the particles during the separating process.

This statement is true. The binding energy is precisely the energy required to separate a nucleus into its individual protons and neutrons. Without this energy, the nucleons would remain bound within the nucleus.

(iii) The binding energy is a measure of how well the nucleons in a nucleus are held together.

This statement is true. The binding energy quantifies the stability of a nucleus. A higher binding energy indicates that the nucleons are held together more tightly.

(iv) The nuclear fission is somehow related to acquiring higher binding energy.

This statement is true. In nuclear fission, a large nucleus splits into two or more smaller nuclei, and the total binding energy of the resulting nuclei is higher than that of the original nucleus. This release of energy is what drives the process of nuclear fission.

Given the analysis above, we find that statements (ii), (iii), and (iv) are true, while statement (i) is false. Thus, the correct answer is:

Option B

Statements (ii), (iii), and (iv) are true.

Question 128

A satellite of mass m rotates round the earth in a circular orbit of radius R . If the angular momentum of the satellite is J , then its kinetic energy (K) and the total energy (E) of the satellite are

Options:

A.

$$K = \frac{J^2}{mR^2}, E = -\frac{J^2}{2mR^2}$$

B.

$$K = \frac{J^2}{2mR^2}, E = -\frac{J^2}{2mR^2}$$

C.

$$K = \frac{J^2}{2mR^2}, E = -\frac{J^2}{mR^2}$$

D.

$$K = \frac{J^2}{2mR^2}, E = \frac{J^2}{mR^2}$$

Answer: B

Solution:

Here's how to determine the kinetic energy (K) and total energy (E) of the satellite:

1. Angular Momentum and Velocity:

The angular momentum (J) of a satellite in circular orbit is given by:

$$J = I\omega = mR^2\omega$$

where:

- m is the mass of the satellite
- R is the orbital radius
- ω is the angular velocity

We can relate angular velocity (ω) to linear velocity (v) using:

$$v = R\omega$$

2. Kinetic Energy:

The kinetic energy of the satellite is:

$$K = \frac{1}{2}mv^2$$

Substituting $v = R\omega$ and $J = mR^2\omega$, we get:

$$K = \frac{1}{2}m(R\omega)^2 = \frac{1}{2}m(J^2/m^2R^4) = \frac{J^2}{2mR^2}$$

3. Total Energy:

The total energy (E) of the satellite is the sum of its kinetic energy (K) and potential energy (U). The potential energy in a gravitational field is:

$$U = -\frac{GMm}{R}$$

where G is the gravitational constant and M is the mass of the Earth.

The total energy is then:

$$E = K + U = \frac{J^2}{2mR^2} - \frac{GMm}{R}$$

We can express the gravitational constant (G) and the mass of the Earth (M) in terms of the acceleration due to gravity (g) at the Earth's surface:

$$GM = gR^2$$

Substituting this into the equation for total energy:

$$E = \frac{J^2}{2mR^2} - \frac{gR^2m}{R} = \frac{J^2}{2mR^2} - gRm$$

Now, using the centripetal acceleration equation, $g = v^2/R = (R\omega)^2/R = R\omega^2$ and substituting $J = mR^2\omega$, we get:

$$gRm = R\omega^2m = \frac{J^2}{mR^2}$$

Therefore, the total energy is:

$$E = \frac{J^2}{2mR^2} - \frac{J^2}{mR^2} = -\frac{J^2}{2mR^2}$$

Conclusion:

The correct answer is **Option B**:

$$K = \frac{J^2}{2mR^2}, E = -\frac{J^2}{2mR^2}$$

Question 129

What force F is required to start moving this 10 kg block shown in the figure if it acts at an angle of 60° as shown? ($\mu_s = 0.6$)

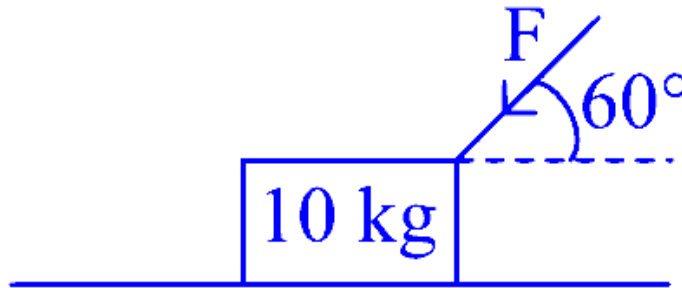

Question is Wrong

Options:

A.

22.72 N

B.

24.97 N

C.

25.56 N

D.

27.32 N

Solution:

$$F \cos 60^\circ < \mu F \sin 60^\circ$$

Block does not move

Question 130

Light of wavelength 6000Å is incident on a thin glass plate of r.i. 1.5 such that the angle of refraction into the plate is 60° . Calculate the smallest thickness of the plate which will make dark fringe by reflected beam interference.

Options:

A.

$$1.5 \times 10^{-7} \text{ m}$$

B.

$$2 \times 10^{-7} \text{ m}$$

C.

$$3.5 \times 10^{-7} \text{ m}$$

D.

$$4 \times 10^{-7} \text{ m}$$

Answer: D

Solution:

Given Data

- Wavelength of light, $\lambda = 6000 \text{Å} = 6000 \times 10^{-10} \text{ m}$
- Refractive index of glass plate, $n = 1.5$
- Angle of refraction, $r = 60^\circ$

Formula for Destructive Interference

The condition for destructive interference (dark fringe) in the reflected light for the smallest thickness is:

$$2nt \cos r = \lambda$$

Applying the Given Values

1. Substitute the given values into the formula:

$$2 \times 1.5 \times t \times \cos 60^\circ = 6000 \times 10^{-10} \text{ m}$$

1. Since $\cos 60^\circ = 0.5$, the equation simplifies to:

$$2 \times 1.5 \times t \times 0.5 = 6000 \times 10^{-10} \text{ m}$$

$$1.5 \times t = 6000 \times 10^{-10} \text{ m}$$

$$t = \frac{6000 \times 10^{-10} \text{ m}}{1.5}$$

1. Solving for t :

$$t = 4000 \times 10^{-10} \text{ m}$$

$$t = 4 \times 10^{-7} \text{ m}$$

Correct Answer

Option D: $4 \times 10^{-7} \text{ m}$

Question 131

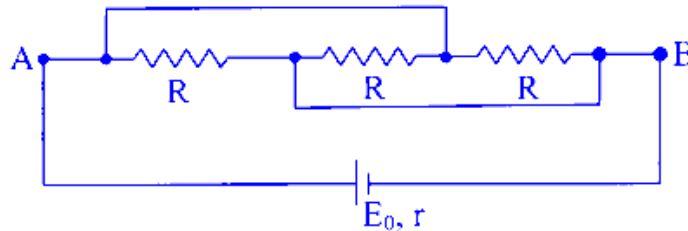

Consider a circuit where a cell of emf E_0 and internal resistance r is connected across the terminal A and B as shown in figure. The value of R for which the power generated in the circuit is maximum, is given by

Options:

A.

$$R = r$$

B.

$$R = 2r$$

C.

$$R = 3r$$

D.

$$R = \frac{r}{3}$$

Answer: C

Solution:

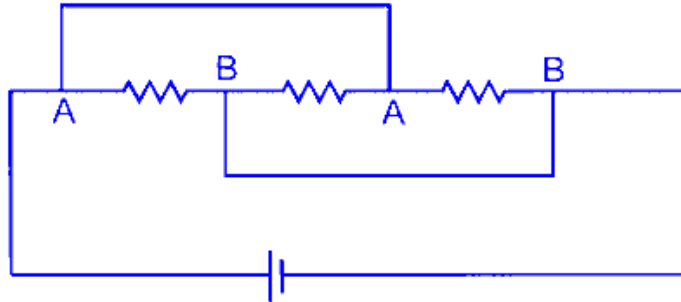

$$R_{eq} = R \parallel R \parallel R = \frac{R}{3}$$

$$\Rightarrow r = R_{eq} = \frac{R}{3}$$

$$\therefore R = 3r$$

Question 132

The equivalent capacitance of a combination of connected capacitors shown in the figure between the points P and N is

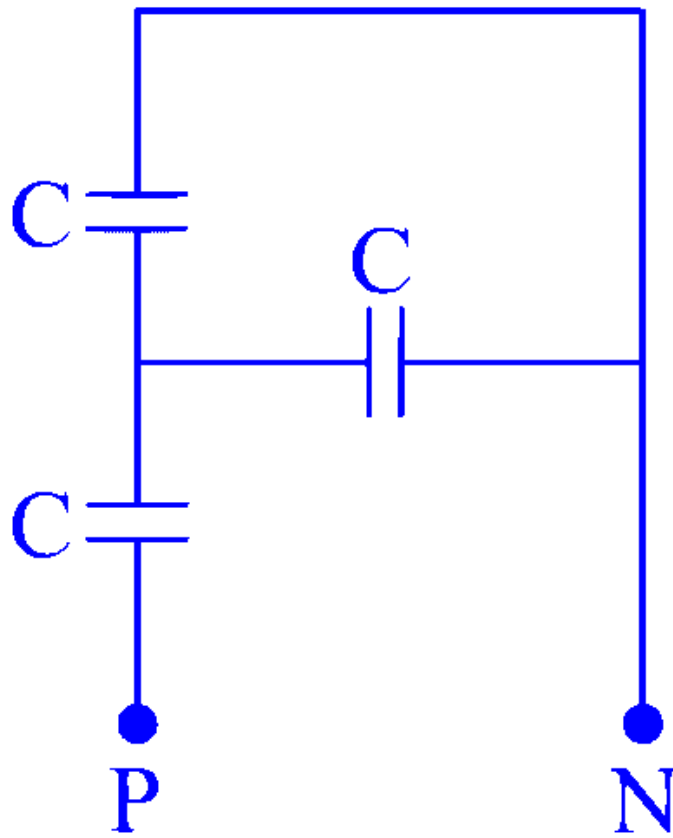

Options:

A.

$3C$

B.

$\frac{2C}{3}$

C.

$\frac{4C}{5}$

D.

$\frac{3}{2}C$

Answer: B

Solution:

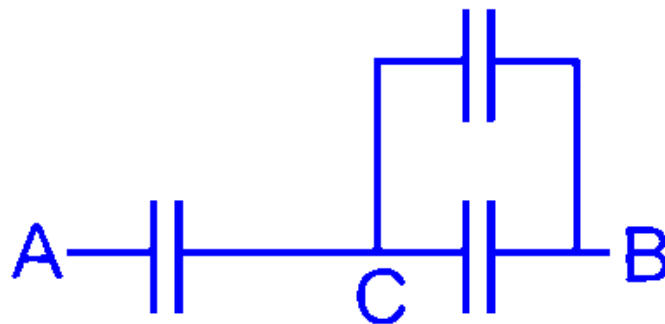
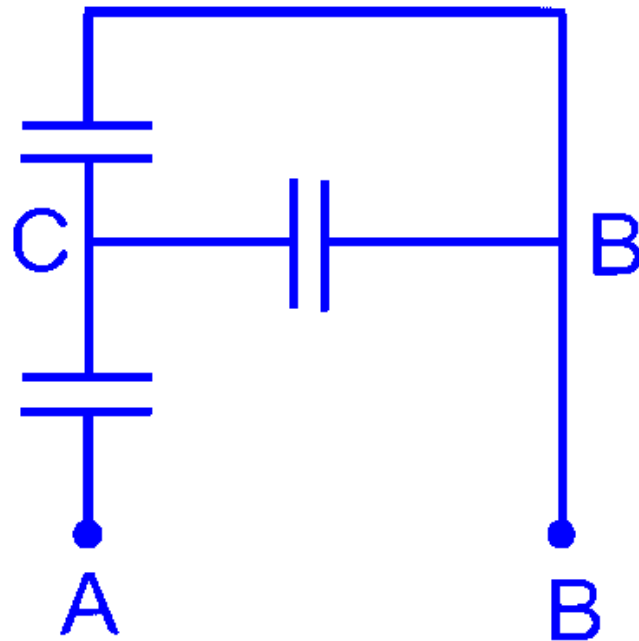

$$C_{\text{eq}} = C \text{ series } (C \parallel C) = \frac{2C}{3}$$

Question 133

In a single-slit diffraction experiment, the slit is illuminated by light of two wavelengths λ_1 and λ_2 . It is observed that the 2nd order diffraction minimum for λ_1 coincides with the 3rd diffraction minimum for λ_2 . Then

Options:

A.

$$\frac{\lambda_1}{\lambda_2} = \frac{2}{3}$$

B.

$$\frac{\lambda_1}{\lambda_2} = \frac{5}{7}$$

C.

$$\frac{\lambda_1}{\lambda_2} = \frac{3}{2}$$

D.

$$\frac{\lambda_1}{\lambda_2} = \frac{7}{5}$$

Answer: C

Solution:

In a single-slit diffraction experiment, the position of the diffraction minima is given by the condition:

$$a \sin \theta = n\lambda$$

where a is the slit width, θ is the angle of diffraction, n is the order of the minimum, and λ is the wavelength of light.

Let's denote the two wavelengths by λ_1 and λ_2 . According to the problem, the 2nd order diffraction minimum for λ_1 coincides with the 3rd order diffraction minimum for λ_2 . This can be written as:

$$a \sin \theta = 2\lambda_1$$

and

$$a \sin \theta = 3\lambda_2$$

Since both conditions are satisfied simultaneously at the same angle θ , we can equate the two expressions:

$$2\lambda_1 = 3\lambda_2$$

Thus, the ratio of the wavelengths is:

$$\frac{\lambda_1}{\lambda_2} = \frac{3}{2}$$

Therefore, the correct option is:

Option C: $\frac{\lambda_1}{\lambda_2} = \frac{3}{2}$

Question 134

The acceleration-time graph of a particle moving in a straight line is shown in the figure. If the initial velocity of the particle is zero then the velocity-time graph of the particle will be

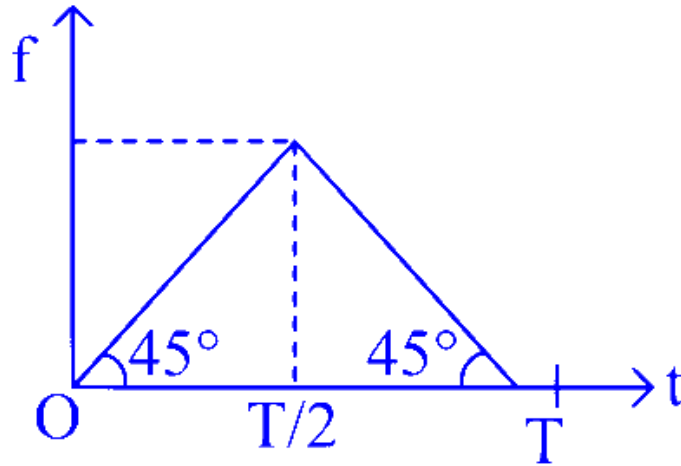

Options:

A.

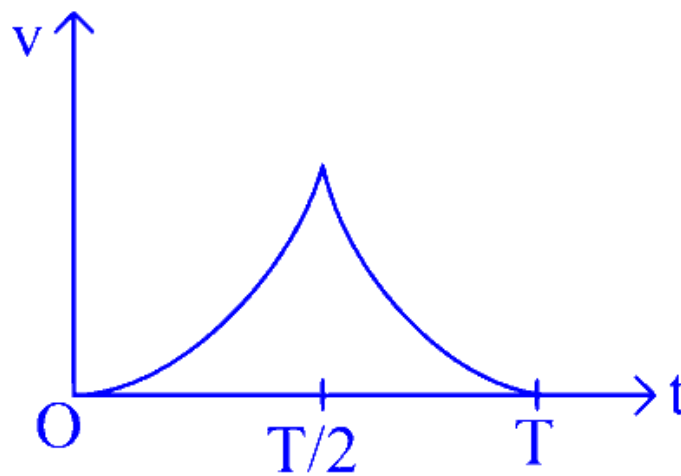

B.

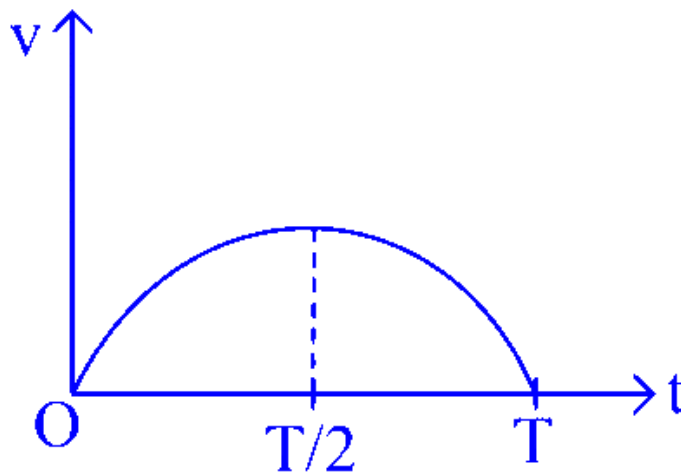

C.

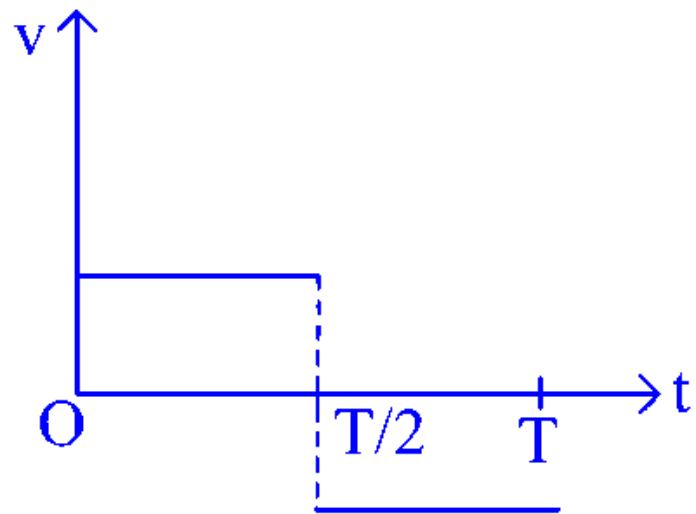

D.

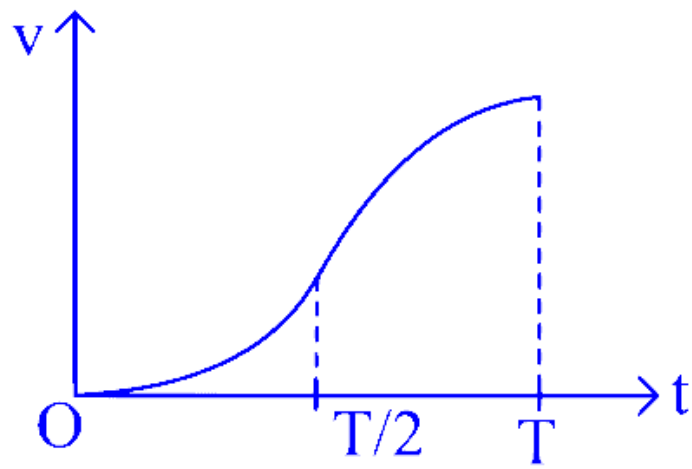

Answer: D

Solution:

$$(a) 0 \leq t \leq \frac{T}{2}$$

$$\frac{df}{dt} = 1$$

$$f = t$$

$$\frac{dv}{dt} = t$$

$$v = \frac{t^2}{2} \text{ parabola (} v \text{ is axis)}$$

$$(v)_{\frac{T}{2}} = \frac{T^2}{8}$$

(b)

$$\frac{T}{2} \leq t \leq T$$

$$\frac{df}{dt} = -1$$

$$f = -t + C_1$$

$$\frac{T}{2} = -\frac{T}{2} + C_1$$

$$C_1 = T$$

$$f = T - t$$

$$V = Tt - \frac{t^2}{2} + C_2$$

$$\frac{T^2}{8} = \frac{T^2}{2} - \frac{T^2}{8} + C_2$$

$$C_2 = \frac{T^2}{4} - \frac{T^2}{2} = -\frac{T^2}{4}$$

$$\therefore V = Tt = \frac{t^2}{2} - \frac{T^2}{4}$$

parabola (axis is parallel to v and downward)

Question 135

The position vector of a particle of mass m moving with a constant velocity \vec{v} is given by $\vec{r} = x(t)\hat{i} + b\hat{j}$, where b is a constant. At an instant, \vec{r} makes an angle θ

with the x -axis as shown in the figure. The variation of the angular momentum of the particle about the origin with θ will be

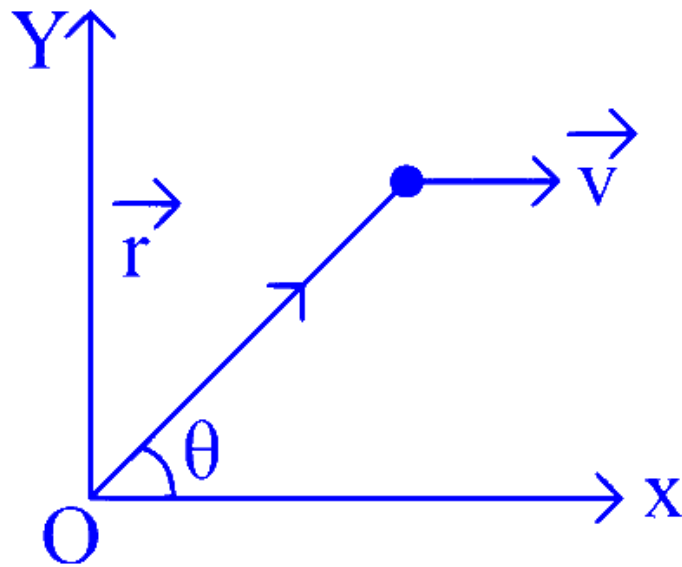

Options:

A.

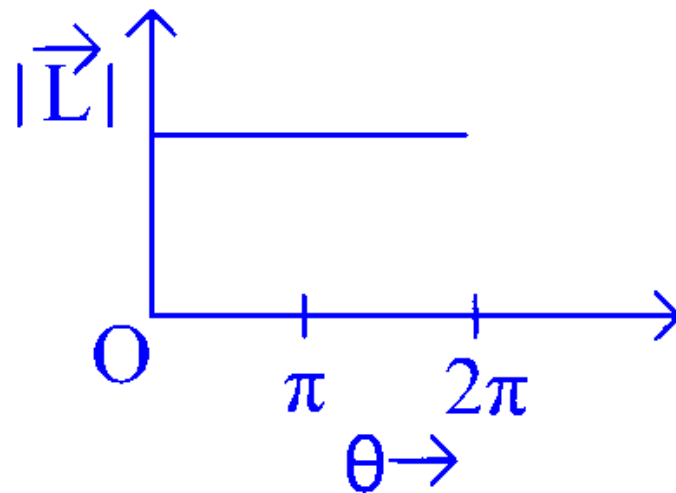

B.

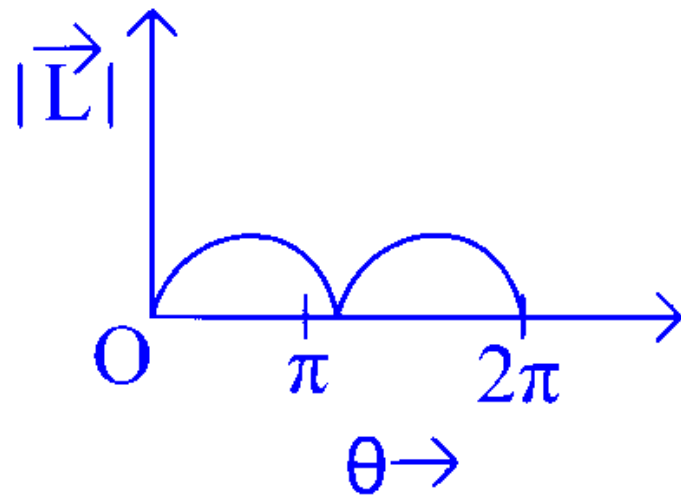

C.

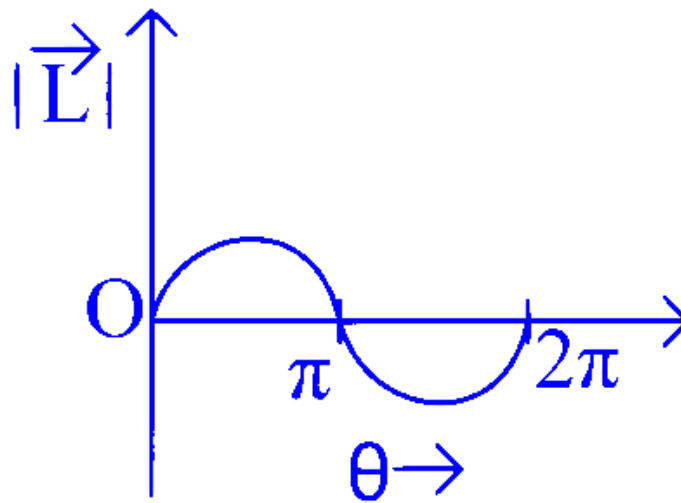

D.

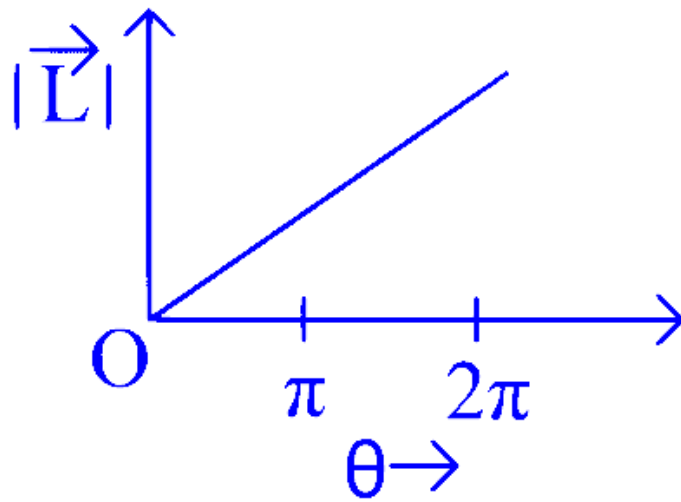

Answer: A

Solution:

$$3M \times x + M \times \frac{a}{2} = 4M \times 0$$

$$\Rightarrow x = -\frac{a}{6}$$

Similarly, $y = -\frac{b}{6}$

Question 137

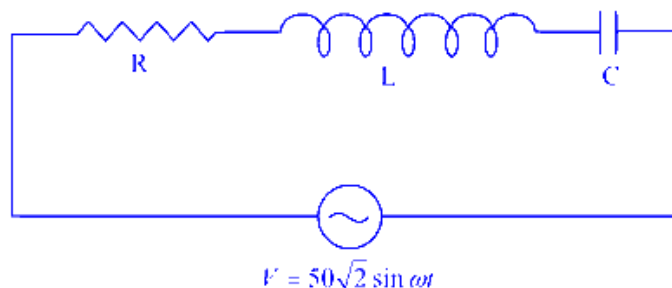

In a series LCR circuit, the rms voltage across the resistor and the capacitor are 30 V and 90 V respectively. If the applied voltage is $50\sqrt{2} \sin \omega t$, then the peak voltage across the inductor is

Options:

A.

70 V

B.

50 V

C.

$70\sqrt{2}$ V

D.

$50\sqrt{2}$ V

Answer: D

Solution:

In a series LCR circuit, we need to find the peak voltage across the inductor given the following data:

The rms voltage across the resistor, V_R , is 30 V.

The rms voltage across the capacitor, V_C , is 90 V.

The applied voltage, V_{applied} , is given by: $V_{\text{applied}} = 50\sqrt{2} \sin \omega t$. This means the peak value of the applied voltage is $V_{\text{peak}} = 50\sqrt{2} \text{ V}$.

First, let's determine the rms voltage of the applied voltage. Since rms voltage is the peak voltage divided by $\sqrt{2}$, we have:

$$V_{\text{rms, applied}} = \frac{50\sqrt{2}}{\sqrt{2}} = 50 \text{ V}.$$

In a series LCR circuit, the total rms voltage is the square root of the sum of the squares of the individual voltage drops. Since the total voltage is applied across the resistor, inductor, and capacitor, we have:

$$V_{\text{total}} = \sqrt{V_R^2 + (V_L - V_C)^2}$$

Given:

- $V_R = 30 \text{ V}$
- $V_C = 90 \text{ V}$
- $V_{\text{rms, total}} = 50 \text{ V}$

Rearranging the equation, we find:

$$50 = \sqrt{30^2 + (V_L - 90)^2}$$

$$50^2 = 30^2 + (V_L - 90)^2$$

$$2500 = 900 + (V_L - 90)^2$$

$$2500 - 900 = (V_L - 90)^2$$

$$1600 = (V_L - 90)^2$$

Taking the square root of both sides:

$$V_L - 90 = \pm 40$$

This gives us two possible values for V_L :

$$V_L = 130 \text{ V or } V_L = 50 \text{ V}$$

To find the peak voltage across the inductor, we need to multiply the rms voltage by $\sqrt{2}$ (since peak voltage $V_{\text{peak}} = V_{\text{rms}} \times \sqrt{2}$):

- For $V_L = 130 \text{ V}$: $V_{\text{peak, L}} = 130 \times \sqrt{2} = 130\sqrt{2} \text{ V}$
- For $V_L = 50 \text{ V}$: $V_{\text{peak, L}} = 50 \times \sqrt{2} = 50\sqrt{2} \text{ V}$

The correct peak voltage across the inductor that matches the options provided is $50\sqrt{2} \text{ V}$. Therefore, the answer is:

Option D: $50\sqrt{2} \text{ V}$

Question 138

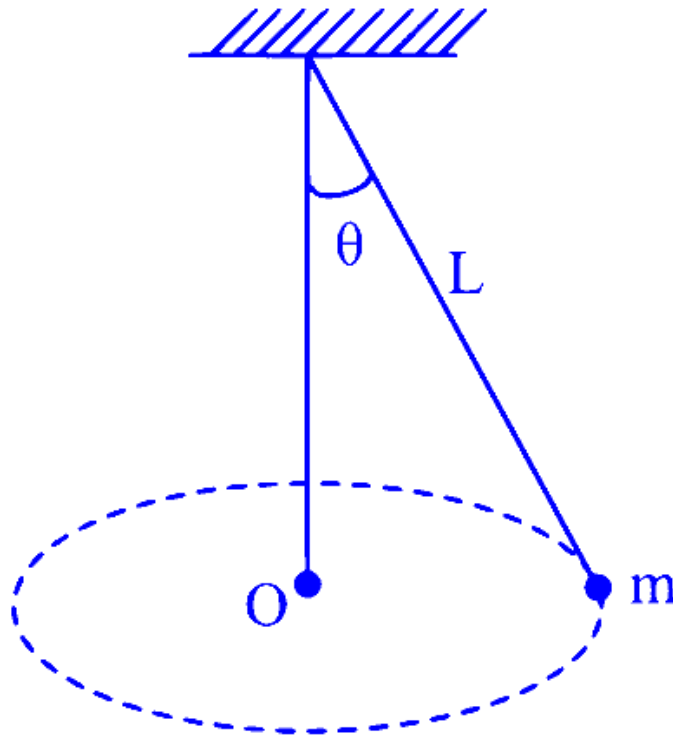

A small ball of mass m is suspended from the ceiling of a floor by a string of length L . The ball moves along a horizontal circle with constant angular velocity ω , as shown in the figure. The torque about the centre (O) of the horizontal circle is

Options:

A.

$$mgL \sin \theta$$

B.

$$mgL$$

C.

$$0$$

D.

$$mgL \cos \theta$$

Answer: C

Solution:

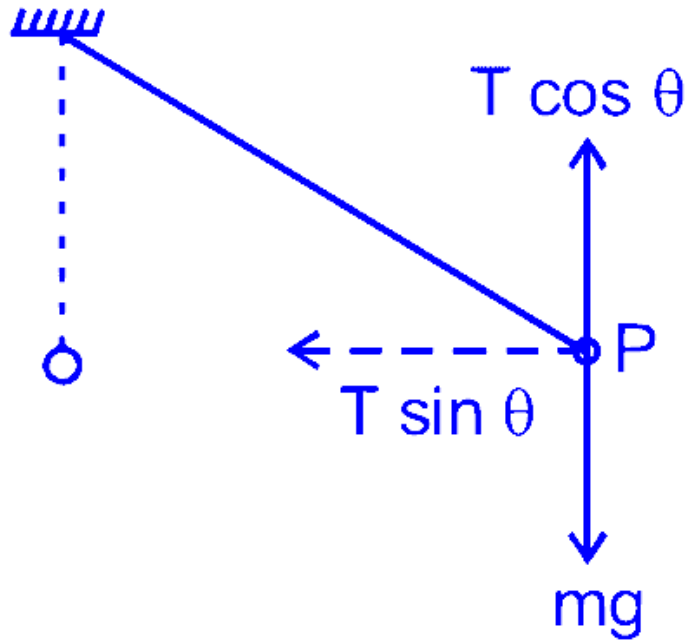

Net force = $T \sin \theta$ along $\overrightarrow{PO} \Rightarrow$ Torque about O is zero.

Question 139

If \hat{n}_1 , \hat{n}_2 and \hat{t} represent, unit vectors along the incident ray, reflected ray and normal to the surface respectively, then

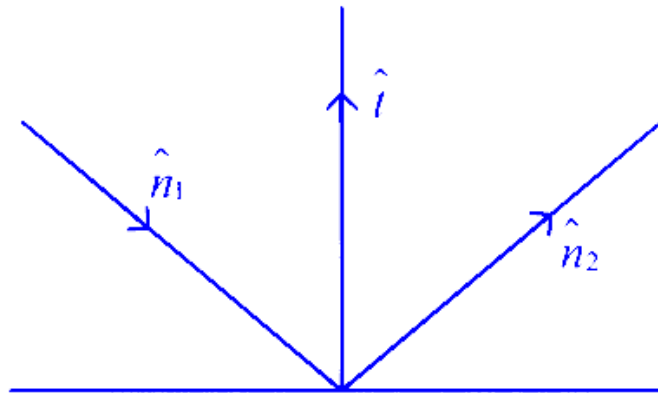

Options:

A.

$$\hat{n}_2 = \hat{n}_1 - 2(\hat{n}_1 \cdot \hat{t})\hat{t}$$

B.

$$\hat{n}_2 = \hat{n}_1 + 2(\hat{n}_1 \cdot \hat{t})\hat{t}$$

C.

$$\hat{n}_2 = -\hat{n}_1$$

D.

$$\hat{n}_2 = 2\hat{n}_1 - (\hat{n}_1 \times \hat{t}) \cdot \hat{n}_1$$

Answer: B

Solution:

Angle of incidence = θ

$$\hat{n}_1 = \cos \theta(-\hat{j}) + \sin \theta(\hat{i})$$

$$\hat{n}_2 = \cos \theta(\hat{j}) + \sin \theta(\hat{i})$$

$$\hat{n}_1 \cdot \hat{t} = \cos(180^\circ - \theta) = -\cos \theta$$

$$\hat{n}_1 - \hat{n}_2 = -2 \cos \theta(\hat{j}) = -2 \cos \theta \hat{t} = +2 (\hat{n}_1 \cdot \hat{t}) \hat{t}$$

$$\hat{n}_2 = \hat{n}_1 - 2 (\hat{n}_1 \cdot \hat{t}) \hat{t}$$

Question 140

A beam of light of wavelength λ falls on a metal having work function ϕ placed in a magnetic field B . The most energetic electrons, perpendicular to the field are bent in circular arcs of radius R . If the experiment is performed for different values of λ , then B^2 vs. $\frac{1}{\lambda}$ graph will look like (keeping all other quantities constant)

Options:

A.

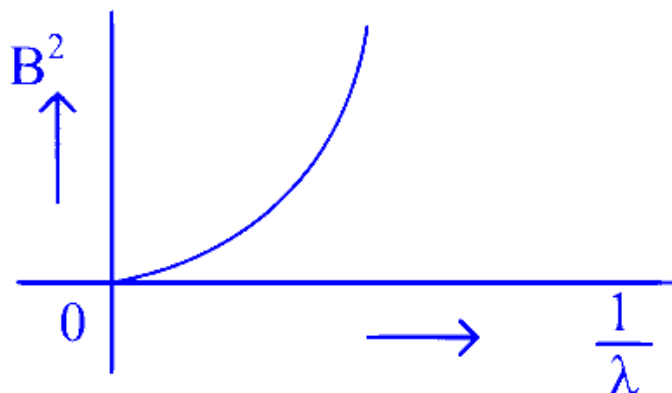

B.

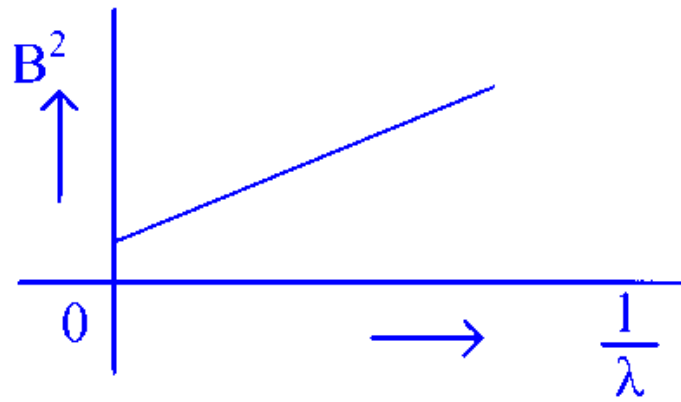

C.

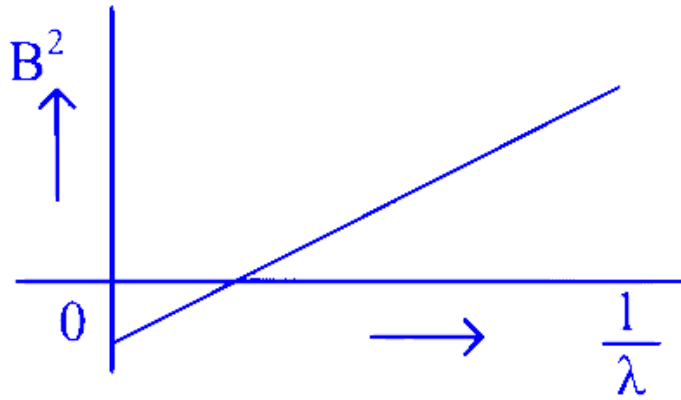

D.

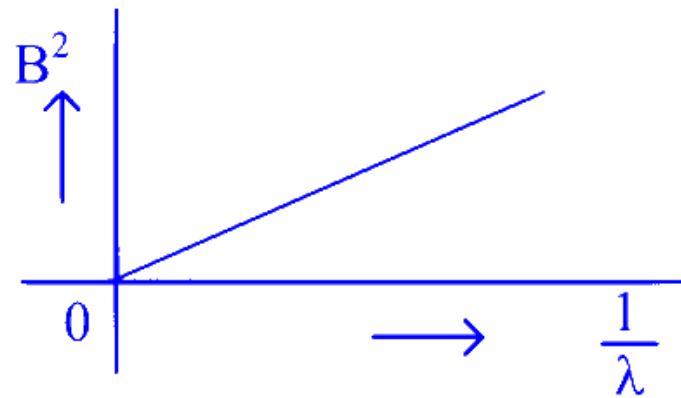

Answer: C

Solution:

To determine the nature of the graph of B^2 vs. $\frac{1}{\lambda}$, we start by analyzing the given problem using the photoelectric effect and the behavior of electrons in a magnetic field.

Photoelectric Effect and Kinetic Energy

The energy of the incident light is given by:

$$E = \frac{hc}{\lambda}$$

where h is Planck's constant, c is the speed of light, and λ is the wavelength of the incident light.

The kinetic energy ($K. E.$) of the emitted photoelectrons, given the work function ϕ , is:

$$K. E. = \frac{hc}{\lambda} - \phi$$

Electron in a Magnetic Field

When these electrons enter a perpendicular magnetic field B , they experience a force that causes them to move in a circular path. The centripetal force required for this motion is provided by the Lorentz force:

$$\frac{mv^2}{R} = evB$$

where:

- m is the mass of the electron,
- v is the velocity of the electron,
- R is the radius of the circular path,
- e is the charge of the electron.

From the above equation, we can solve for v :

$$v = \frac{eBR}{m}$$

Relationship between Kinetic Energy and Velocity

The kinetic energy of the electrons can also be expressed as:

$$K. E. = \frac{1}{2}mv^2$$

Substituting $v = \frac{eBR}{m}$ into the kinetic energy equation, we get:

$$\frac{1}{2}m\left(\frac{eBR}{m}\right)^2 = \frac{1}{2}\frac{e^2B^2R^2}{m}$$

$$K. E. = \frac{e^2B^2R^2}{2m}$$

Combining Both Expressions for Kinetic Energy

We already have:

$$K. E. = \frac{hc}{\lambda} - \phi$$

Equating both expressions for kinetic energy:

$$\frac{e^2B^2R^2}{2m} = \frac{hc}{\lambda} - \phi$$

Rearranging to isolate B^2 :

$$B^2 = \frac{2m}{e^2R^2} \left(\frac{hc}{\lambda} - \phi \right)$$

$$B^2 = \frac{2mhc}{e^2R^2} \cdot \frac{1}{\lambda} - \frac{2m\phi}{e^2R^2}$$

Form of the Graph

This equation is in the form of a straight line $y = mx + c$ where:

- $y = B^2$

- $x = \frac{1}{\lambda}$
- $m = \frac{2mhc}{e^2 R^2}$
- $c = -\frac{2m\phi}{e^2 R^2}$

Thus, the graph of B^2 vs. $\frac{1}{\lambda}$ will be a straight line with a positive slope and a negative y-intercept.

The correct graph will be a straight line with a positive slope and negative y-intercept:

Option C

Question 141

A charged particle moving with a velocity $\vec{v} = v_1\hat{i} + v_2\hat{j}$ in a magnetic field \vec{B} experiences a force $\vec{F} = F_1\hat{i} + F_2\hat{j}$. Here v_1, v_2, F_1, F_2 all are constants. Then \vec{B} can be

Options:

A.

$$\vec{B} = B_1\hat{i} + B_2\hat{j} \text{ with } \frac{v_1}{v_2} = \frac{B_1}{B_2}$$

B.

$$\vec{B} = B_1\hat{i} + B_2\hat{j} + B_3\hat{k} \text{ with } \frac{v_1}{v_2} = \frac{B_1}{B_2}$$

C.

$$\vec{B} = B_3\hat{j} \text{ with } B_1 = B_2 = 0$$

D.

$$\vec{B} = B_1\hat{j} + B_2\hat{k} \text{ with } \frac{B_1}{B_2} = \frac{v_1}{v_2}$$

Answer: B

Solution:

To determine the magnetic field \vec{B} , we need to apply the Lorentz force equation. The force experienced by a charged particle moving with velocity \vec{v} in a magnetic field \vec{B} is given by:

$$\vec{F} = q \cdot (\vec{v} \times \vec{B})$$

Here, \vec{v} is the velocity of the particle and \vec{B} is the magnetic field. Given:

$$\vec{v} = v_1 \hat{i} + v_2 \hat{j}$$

and

$$\vec{F} = F_1 \hat{i} + F_2 \hat{j}$$

We need to calculate $\vec{v} \times \vec{B}$ in different scenarios and equate to \vec{F} to determine the appropriate \vec{B} .

Let's consider each option:

Option A: $\vec{B} = B_1 \hat{i} + B_2 \hat{j}$, where $\frac{v_1}{v_2} = \frac{B_1}{B_2}$.

Calculating the cross product:

$$\vec{v} \times \vec{B} = (v_1 \hat{i} + v_2 \hat{j}) \times (B_1 \hat{i} + B_2 \hat{j})$$

Since

$$\hat{i} \times \hat{i} = 0,$$

$$\hat{j} \times \hat{j} = 0,$$

$$\hat{i} \times \hat{j} = \hat{k}, \text{ and } \hat{j} \times \hat{i} = -\hat{k},$$

The cross product will be zero:

$$\vec{v} \times \vec{B} = 0$$

This means that the force would be zero, which contradicts the given condition. Thus, Option A is invalid.

Option B: $\vec{B} = B_1 \hat{i} + B_2 \hat{j} + B_3 \hat{k}$, with $\frac{v_1}{v_2} = \frac{B_1}{B_2}$.

Calculating the cross product:

$$\vec{v} \times \vec{B} = (v_1\hat{i} + v_2\hat{j}) \times (B_1\hat{i} + B_2\hat{j} + B_3\hat{k})$$

$$= v_1(\hat{i} \times B_3\hat{k}) + v_2(\hat{j} \times B_3\hat{k})$$

Which yields:

$$= v_1B_3(-\hat{j}) + v_2B_3\hat{i}$$

$$= B_3(v_2\hat{i} - v_1\hat{j})$$

This produces a force in the \hat{i} and \hat{j} directions, aligned correctly for constants F_1 and F_2 . Therefore, Option B is valid under the given conditions.

Option C: $\vec{B} = B_3\hat{j}$, where $B_1 = B_2 = 0$.

Calculating the cross product:

$$\vec{v} \times \vec{B} = (v_1\hat{i} + v_2\hat{j}) \times (0\hat{i} + B_3\hat{j})$$

The resultant force will be :

$$\vec{v} \times \vec{B} = 0$$

Thus, Option C is invalid.

Option D: $\vec{B} = B_1\hat{j} + B_2\hat{k}$, with $\frac{B_1}{B_2} = \frac{v_1}{v_2}$.

Calculating the cross product:

$$\vec{v} \times \vec{B} = (v_1\hat{i} + v_2\hat{j}) \times (B_1\hat{j} + B_2\hat{k})$$

The resultant force will be:

$$v_1\hat{i} \times B_1\hat{j} = v_1B_1\hat{k}$$

$$v_2 \hat{j} \times B_2 \hat{k} = v_2 B_2 \hat{i}$$

Therefore:

$$\vec{v} \times \vec{B} = v_2 B_2 \hat{i} + v_1 B_1 \hat{k}$$

This produces a force in both directions, but does not align with the given force vectors. Therefore, Option D is not valid.

The correct and valid option is:

Option B: $\vec{B} = B_1 \hat{i} + B_2 \hat{j} + B_3 \hat{k}$ with $\frac{v_1}{v_2} = \frac{B_1}{B_2}$.

Question 142

Two straight conducting plates form an angle θ where their ends are joined. A conducting bar in contact with the plates and forming an isosceles triangle with them starts at the vertex at time $t = 0$ and moves with constant velocity \vec{v} to the right as shown in figure. A magnetic field \vec{B} points out of the page. The magnitude of emf induced at $t = 1$ second will be

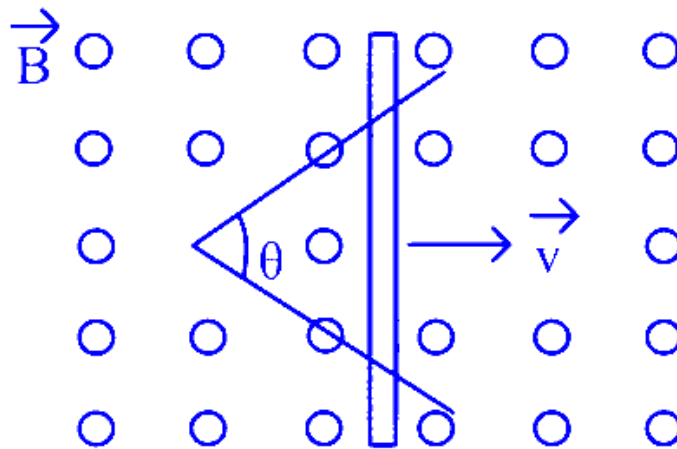

Options:

A.

$$Bv \tan \frac{\theta}{2}$$

B.

$$2Bv^2 \tan \frac{\theta}{2}$$

C.

$$2Bv^2 \cot \frac{\theta}{2}$$

D.

$$2Bv^2 \sin \frac{\theta}{2}$$

Answer: B

Solution:

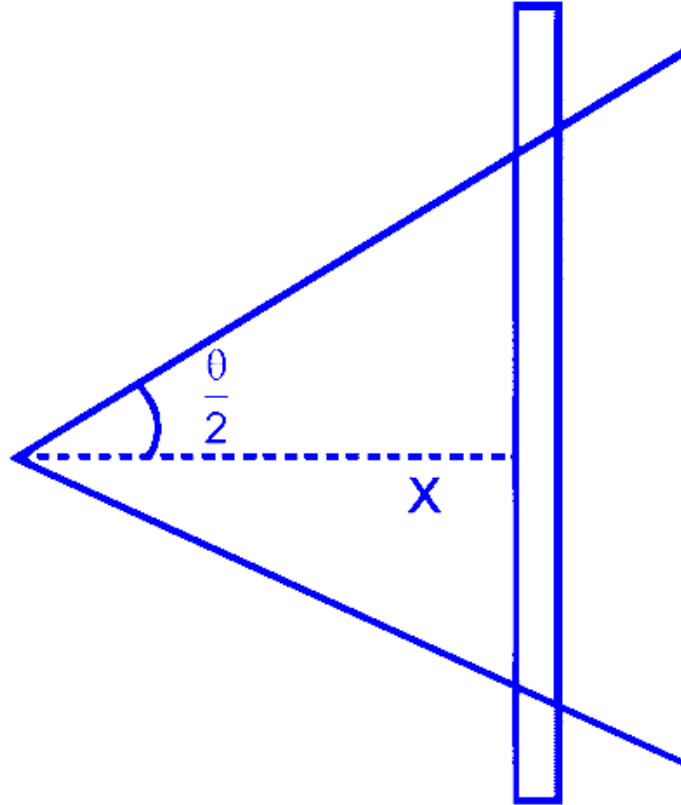

$$\text{Area} = \frac{1}{2} (2x \tan \frac{\theta}{2}) x$$

$$\text{flux, } \varphi = \left(x^2 \tan \frac{\theta}{2} \right) B$$

$$\frac{d\varphi}{dt} = \left(2x \frac{dx}{dt} \tan \frac{\theta}{2} \right) B = 2xvB \tan \frac{\theta}{2} = 2(vt)vB \tan \frac{\theta}{2}$$

$$\text{At } t = 1 \text{ sec, } \varepsilon = 2v^2 B \tan \frac{\theta}{2}$$

Question 143

Three point charges q , $-2q$ and q are placed along x axis at $x = -a$, 0 and a respectively. As $a \rightarrow 0$ and $q \rightarrow \infty$ while $qa^2 = Q$ remains finite, the electric field at a point P, at a distance x ($x \gg a$) from $x = 0$ is $\vec{E} = \frac{\alpha Q}{4\pi\epsilon_0 x^\beta} \hat{i}$. Then

Options:

A.

$$\alpha = \beta$$

B.

$$\alpha = 2\beta$$

C.

$$\alpha = \frac{2}{3}\beta$$

D.

$$2\alpha = 3\beta$$

Answer: C

Solution:

The electric field at point P due to each charge can be calculated using Coulomb's law. Let's consider the electric field due to the charge +q at x = -a.

The distance between the charge and point P is approximately x + a (since x >> a). So, the electric field due to this charge is:

$$\vec{E}_1 = \frac{kq}{(x+a)^2} \hat{i}$$

Similarly, the electric field due to the charge -2q at x = 0 is:

$$\vec{E}_2 = -\frac{2kq}{x^2} \hat{i}$$

And the electric field due to the charge +q at x = a is:

$$\vec{E}_3 = \frac{kq}{(x-a)^2} \hat{i}$$

The total electric field at point P is the vector sum of these three fields:

$$\vec{E} = \vec{E}_1 + \vec{E}_2 + \vec{E}_3$$

Substituting the expressions for each field, we get:

$$\vec{E} = \frac{kq}{(x+a)^2} \hat{i} - \frac{2kq}{x^2} \hat{i} + \frac{kq}{(x-a)^2} \hat{i}$$

Now, let's simplify this expression using the binomial approximation, since x >> a. The binomial approximation states that for small values of a/x, we can approximate $(1 + a/x)^n \approx 1 + na/x$. Applying this approximation to the terms in the expression for E, we get:

$$\vec{E} = kq \left[\frac{1}{(x+a)^2} - \frac{2}{x^2} + \frac{1}{(x-a)^2} \right] \hat{i}$$

$$\vec{E} = kq \left[\frac{1}{x^2(1+a/x)^2} - \frac{2}{x^2} + \frac{1}{x^2(1-a/x)^2} \right] \hat{i}$$

$$\vec{E} = \frac{kq}{x^2} [(1 + a/x)^{-2} - 2 + (1 - a/x)^{-2}] \hat{i}$$

$$\vec{E} = \frac{kq}{x^2} [(1 - 2a/x + 3a^2/x^2) - 2 + (1 + 2a/x + 3a^2/x^2)] \hat{i}$$

$$\vec{E} = \frac{kq}{x^2} [6a^2/x^2] \hat{i}$$

$$\vec{E} = \frac{6kqa^2}{x^4} \hat{i}$$

Now, we are given that $qa^2 = Q$. Substituting this into the expression for E, we get:

$$\vec{E} = \frac{6kQ}{x^4} \hat{i} = \frac{1}{4\pi\epsilon_0} \frac{6Q}{x^4}$$

Comparing this to the given expression for E, we see that $\alpha = 6$ and $\beta = 4$. Therefore, $2\alpha = 3\beta$.

So the correct answer is **Option D: $2\alpha = 3\beta$** .

Question 144

A body floats with $\frac{1}{n}$ of its volume keeping outside of water. If the body has been taken to height h inside water and released, it will come to the surface after time t. Then

Options:

A.

$$t \propto \sqrt{n}$$

B.

$$t \propto n$$

C.

$$t \propto \sqrt{n+1}$$

D.

$$t \propto \sqrt{n-1}$$

Answer: D

Solution:

$$Vdg = V \left(1 - \frac{1}{n}\right) \rho g$$

$$d = \left(\frac{n-1}{n}\right) \rho$$

$$a = \frac{V\rho g - Vdg}{Vd} = \left(\frac{\rho}{d} - 1\right)g = \left(\frac{n}{n-1} - 1\right)g = \frac{g}{n-1}$$

$$h = \frac{1}{2}at^2, \quad t = \sqrt{\frac{2h}{a}} = \sqrt{\frac{2h(n-1)}{g}}$$

$$\therefore t \propto \sqrt{n-1}$$

Question 145

A small sphere of mass m and radius r slides down the smooth surface of a large hemispherical bowl of radius R . If the sphere starts sliding from rest, the total kinetic energy of the sphere at the lowest point A of the bowl will be [given, moment of inertia of sphere = $\frac{2}{5}mr^2$]

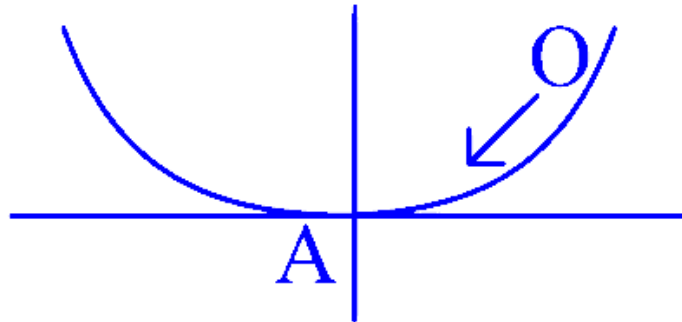

Options:

A.

$$mg(R - r)$$

B.

$$\frac{7}{10}mg(R - r)$$

C.

$$\frac{2}{7}mg(R - r)$$

D.

$$\frac{10}{7}mg(R - r)$$

Answer: A

Solution:

Here sphere is sliding instead of rolling, there is no rotational kinetic energy to consider. Therefore, we only need to consider the translational kinetic energy.

Initial and Final Energy States

Initial Energy (at the top):

The sphere starts from rest, so the initial kinetic energy is zero. The initial potential energy is given by:

$$\text{Potential Energy}_{\text{initial}} = mg(h)$$

Since the sphere starts sliding from the top of the hemispherical bowl, the height h from which it slides is the distance from the center of the sphere to the bottom of the bowl, which is $R - r$:

$$\text{Potential Energy}_{\text{initial}} = mg(R - r)$$

Final Energy (at the bottom):

At the lowest point A , the potential energy is zero (as we take this as the reference level). The kinetic energy at the lowest point is purely translational because the sphere is sliding:

$$K = \frac{1}{2}mv^2$$

Energy Conservation

Using conservation of energy, the initial potential energy is completely converted into translational kinetic energy at the bottom:

$$mg(R - r) = \frac{1}{2}mv^2$$

Thus, the total kinetic energy at the bottom is:

$$K = mg(R - r)$$

Correct Answer

Option A: $mg(R - r)$

Question 146

When a convex lens is placed above an empty tank, the image of a mark at the bottom of the tank, which is 45 cm from the lens is formed 36 cm above the lens. When a liquid is poured in the tank to a depth of 40 cm, the distance of the image of the mark above the lens is 48 cm. The refractive index of the liquid is

Options:

A.

1.353

B.

1.544

C.

1.472

D.

1.366

Answer: D

Solution:

Let's start by analyzing the situation when the tank is empty. According to the lens formula:

$$\frac{1}{f} = \frac{1}{v} - \frac{1}{u}$$

Here, u is the object distance (negative because the object is on the same side as the incident light), and v is the image distance.

When the tank is empty:

$$u = -45 \text{ cm}, \quad v = 36 \text{ cm}$$

Using the lens formula, we can find the focal length f :

$$\frac{1}{f} = \frac{1}{36} - \frac{1}{-45}$$

$$\frac{1}{f} = \frac{1}{36} + \frac{1}{45}$$

$$\frac{1}{f} = \frac{45+36}{36 \times 45} = \frac{81}{1620} = \frac{1}{20}$$

$$f = 20 \text{ cm}$$

Now, when the tank is filled with liquid to a depth of 40 cm, the refractive index μ of the liquid will affect the apparent depth of the mark.

The mark appears to be upward due to the refraction and new object distance can be given by:

$$\frac{\text{Apparent depth}}{\text{Actual depth}} = \frac{h'}{h} = \frac{u'}{u}$$

$$\frac{u'}{-45} = \frac{u'}{-(45-40)} = -\frac{\mu-1}{\mu}$$

Now the apparent mark will form a new object for the lens, let the new object distance be:

$$u' = -5 \text{ cm}$$

$$u_{\text{new}} = -5\mu$$

Image formation now:

$$v = 48 \text{ cm}$$

$$\frac{1}{f} = \frac{1}{48} - \frac{1}{u}$$

$$\frac{1}{20} = \frac{1}{48} - \frac{1}{u}$$

$$\frac{1}{u} = \frac{1}{48} - \frac{1}{20}$$

$$\frac{1}{u} = \frac{20-48}{20 \times 48} = \frac{-28}{960} = -\frac{1}{34.28}$$

$$u = -34.28$$

$$5\mu = 34.28$$

$$\mu = \frac{34.28}{5} = 1.366$$

Therefore, the refractive index of the liquid is 1.366, which corresponds to Option D.

Question 147

In the given network of AND and OR gates, output Q can be written as (assuming n even)

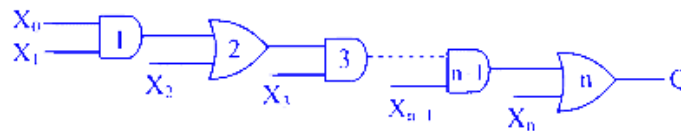

Options:

A.

$$X_0X_1 + X_2X_3 + \dots + X_{n-1}X_n$$

B.

$$X_0X_1 \dots X_n + X_1X_2 \dots X_n + X_2X_3 \dots X_n + X_n$$

C.

$$X_0X_1 \dots X_{n-1} + X_{n-2}X_{n-1} + X_n$$

D.

$$X_0X_1 \dots X_{n-1} + X_2X_3X_5 \dots X_{n-1} + X_{n-2}X_{n-1} + X_n$$

Answer: D

Solution:

To find the pattern and the correct expression for the output Q in the given network of AND and OR gates, let's analyze the structure and the recursive formation of the expressions.

Step-by-Step Analysis

1. First Layer (Base case):

- $Q_1 = X_0 \wedge X_1$

1. Second Layer:

- $Q_2 = (X_0 \wedge X_1) \vee X_2$

- $Q_2 = X_0X_1 + X_2$

1. Third Layer:

- $Q_3 = ((X_0 \wedge X_1) \vee X_2) \wedge X_3$

- $Q_3 = (X_0X_1 + X_2) \wedge X_3$

- $Q_3 = X_0X_1X_3 + X_2X_3$

1. Fourth Layer:

- $Q_4 = ((X_0 \wedge X_1) \vee (X_2 \wedge X_3)) \vee X_4$

- $Q_4 = (X_0X_1X_3 + X_2X_3) + X_4$

- $Q_4 = X_0X_1X_3 + X_2X_3 + X_4$

1. Fifth Layer:

- $Q_5 = ((X_0 \wedge X_1 \wedge X_3) \vee (X_2 \wedge X_3) \vee X_4) \wedge X_5$

- $Q_5 = (X_0X_1X_3 + X_2X_3 + X_4) \wedge X_5$

- $Q_5 = X_0X_1X_3X_5 + X_2X_3X_5 + X_4X_5$

General Pattern

From the above steps, the output Q at each layer can be generalized as:

$$Q_n = X_0X_1X_3X_5 \dots X_{n-1} + X_2X_3X_5 \dots X_{n-1} + \dots + X_{n-2}X_{n-1} + X_n$$

Thus, we can see that:

- The output Q consists of products of increasing sequences of inputs, where each sequence starts from the lowest indexed unpaired input and progresses through alternating even and odd indices.

Correct Answer

Based on the general pattern and the final expression for Q :

Option D: $X_0X_1 \dots X_{n-1} + X_2X_3X_5 \dots X_{n-1} + X_{n-2}X_{n-1} + X_n$

Question 148

Water is filled in a cylindrical vessel of height H . A hole is made at height z from the bottom, as shown in the figure. The value of z for which the range (R) of the emerging water through the hole will be maximum for

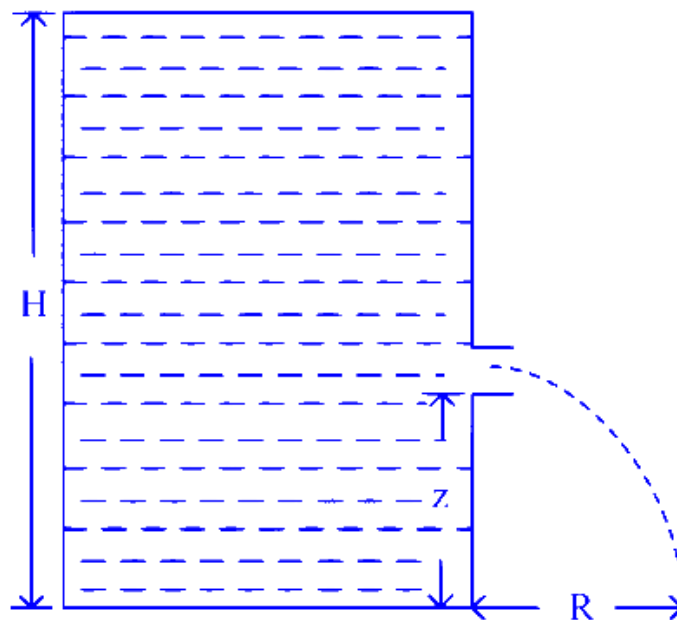

Options:

A.

$$z = \frac{H}{4}$$

B.

$$z = \frac{H}{2}$$

C.

$$z = \frac{H}{8}$$

D.

$$z = \frac{H}{3}$$

Answer: B

Solution:

To determine the height z for which the range R of the emerging water through the hole will be maximum, we need to analyze the problem using the principles of fluid dynamics and projectile motion.

When fluid flows out of a hole in a tank, the speed at which it exits can be described by Torricelli's theorem, which states:

$$v = \sqrt{2g(H - z)}$$

where:

- v is the velocity of the water exiting the hole,
- g is the acceleration due to gravity,
- H is the height of the water column above the hole, and
- z is the height of the hole from the bottom of the vessel.

Next, we consider that the water emerging from the hole would follow a parabolic trajectory due to gravity. The range R (horizontal distance) is given by:

$$R = v \cdot t$$

where:

- v is the horizontal component of the initial velocity (since it exits horizontally), and
- t is the time of flight, given by the time it takes to fall from height z to the ground.

Time of flight t can be determined from the kinematic equation:

$$z = \frac{1}{2}gt^2 \implies t = \sqrt{\frac{2z}{g}}$$

So, the range R can be expressed as:

$$R = \sqrt{2g(H - z)} \cdot \sqrt{\frac{2z}{g}}$$

$$R = 2\sqrt{z(H - z)}$$

To maximize R , we need to find the value of z that maximizes the function $R = 2\sqrt{z(H - z)}$. We can do this by taking the derivative with respect to z and setting it to zero:

$$\frac{d}{dz} \left(2\sqrt{z(H - z)} \right) = 0$$

Let:

$$R = 2\sqrt{z(H - z)}$$

$$\frac{dR}{dz} = 2 \cdot \frac{1}{2} (z(H - z))^{-\frac{1}{2}} \cdot (H - 2z) = \frac{H - 2z}{\sqrt{z(H - z)}}$$

Setting the derivative to zero:

$$\frac{H - 2z}{\sqrt{z(H - z)}} = 0$$

$$H - 2z = 0$$

$$z = \frac{H}{2}$$

Therefore, the height z for which the range R of the emerging water will be maximum is:

Option B: $z = \frac{H}{2}$

Question 149

A metal plate of area 10^{-2} m^2 rests on a layer of castor oil, $2 \times 10^{-3} \text{ m}$ thick, whose coefficient of viscosity is 1.55 N s m^{-2} . The approximate horizontal force required to move the plate with a uniform speed of $3 \times 10^{-2} \text{ ms}^{-1}$ is

Options:

A.

0.6718 N

B.

0.2325 N

C.

0.2022 N

D.

0.6615 N

Answer: B

Solution:

To determine the horizontal force required to move the metal plate with a uniform speed, we can use the formula for viscous force, which is given by:

$$F = \eta \cdot A \cdot \frac{v}{d}$$

where:

- η is the coefficient of viscosity (given as 1.55 N s m^{-2}).
- A is the area of the metal plate (given as 10^{-2} m^2).
- v is the uniform speed of the plate (given as $3 \times 10^{-2} \text{ ms}^{-1}$).
- d is the thickness of the castor oil layer (given as $2 \times 10^{-3} \text{ m}$).

Substituting the given values into the formula, we get:

$$F = 1.55 \cdot 10^{-2} \cdot \frac{3 \times 10^{-2}}{2 \times 10^{-3}}$$

First, handle the fraction:

$$\frac{3 \times 10^{-2}}{2 \times 10^{-3}} = \frac{3}{2} \times 10^1 = 1.5 \times 10$$

Now, substitute this back into the equation for the force:

$$F = 1.55 \cdot 10^{-2} \cdot 15 = 1.55 \cdot 0.15$$

Finally, calculate the force:

$$F = 0.2325 \text{ N}$$

Therefore, the approximate horizontal force required to move the plate with a uniform speed is:

Option B: 0.2325 N

Question 150

The following figure shows the variation of potential energy $V(x)$ of a particle with distance x . The particle has

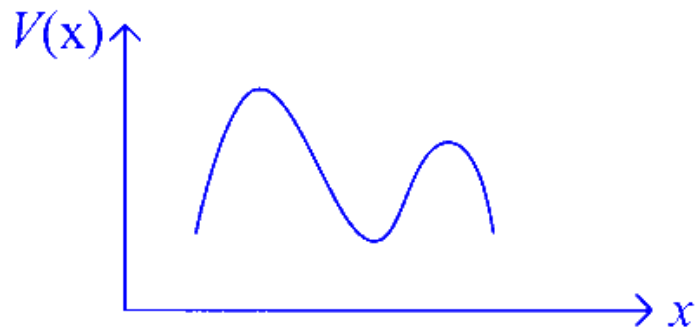

Options:

A.

Two equilibrium points, one stable another unstable

B.

Two equilibrium points, both stable

C.

Three equilibrium points, one stable two unstable

D.

Three equilibrium points, two stable one unstable

Answer: C

Solution:

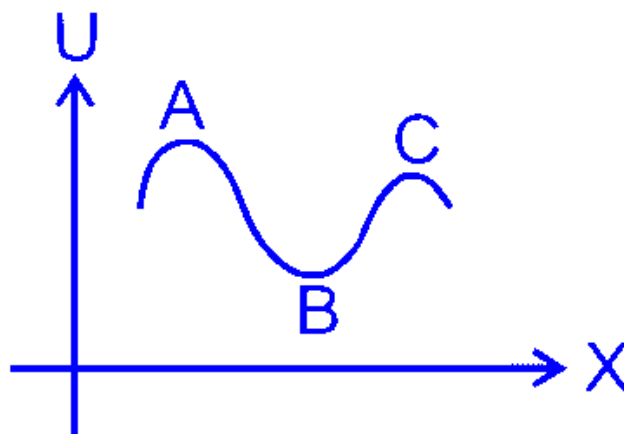

A, C : Unstable equilibrium

B : Stable equilibrium

Question 151

Monochromatic light of wavelength $\lambda = 4770\overset{\circ}{\text{A}}$ is incident separately on the surfaces of four different metals A, B, C and D. The work functions of A, B, C and D are 4.2 eV, 3.7 eV, 3.2 eV and 2.3 eV, respectively. The metal / metals from which electrons will be emitted is / are

Options:

A.

A, B, C and D

B.

B, C and D

C.

C and D

D.

D only

Answer: D

Solution:

To determine from which metals electrons will be emitted, we need to determine if the energy of the incident monochromatic light is greater than the work function of the metal. The energy of the incident light can be calculated using the formula:

$$E = \frac{hc}{\lambda}$$

where:

- h is Planck's constant: 6.626×10^{-34} Js
- c is the speed of light: 3×10^8 m/s
- λ is the wavelength of the light in meters

Given that the wavelength $\lambda = 4770\overset{\circ}{\text{A}}$ (which is equivalent to 4770×10^{-10} m), we can substitute into the formula:

$$E = \frac{6.626 \times 10^{-34} \times 3 \times 10^8}{4770 \times 10^{-10}}$$

By calculating this, we get:

$$E \approx 4.155 \times 10^{-19} \text{ J}$$

To convert this energy from joules (J) to electron volts (eV), we use the conversion factor of $1 \text{ eV} = 1.602 \times 10^{-19} \text{ J}$:

$$E \approx \frac{4.155 \times 10^{-19}}{1.602 \times 10^{-19}} \text{ eV}$$

This simplifies to:

$$E \approx 2.59 \text{ eV}$$

Now, we compare this energy with the work functions of the metals A, B, C, and D:

- A: 4.2 eV
- B: 3.7 eV
- C: 3.2 eV
- D: 2.3 eV

Since the energy of the incident light (2.59 eV) is less than the work functions of metals A (4.2 eV), B (3.7 eV), and C (3.2 eV), electrons will not be emitted from these metals. However, the energy is greater than the work function of metal D (2.3 eV), so electrons will be emitted from metal D.

Therefore, the correct answer is:

Option D: D only

Question 152

Consider the integral form of the Gauss' law in electrostatics

$$\oint \vec{E} \cdot d\vec{S} = \frac{Q}{\epsilon_0}$$

Which of the following statements are correct?

Options:

A.

It contains law of Coulomb.

B.

It contains superposition principle.

C.

An elementary patch on the enclosing surface is a polar vector.

D.

An elementary patch on the enclosing surface is a pseudo-vector.

Answer: A

Solution:

To answer this question, we need to understand the various components of Gauss' Law in electrostatics and how it relates to the given options:

Gauss' Law in electrostatics is given by the integral form:

$$\oint \vec{E} \cdot d\vec{S} = \frac{Q}{\epsilon_0}$$

In this equation:

- \vec{E} is the electric field vector.
- $d\vec{S}$ is the differential vector element of the surface area on a closed surface.
- Q is the total charge enclosed within the surface.
- ϵ_0 is the permittivity of free space.

Let's examine each option to determine which statements are correct:

Option A: It contains the law of Coulomb.

Gauss' Law is directly derived from Coulomb's law for a point charge. It states that the net electric flux through any closed surface is proportional to the charge enclosed within that surface. Therefore, this statement is correct. Gauss' Law essentially generalizes Coulomb's law to any closed surface.

Option B: It contains the superposition principle.

Gauss' Law inherently relies on the superposition principle. The total electric field due to multiple charges is the vector sum of the electric fields due to individual charges. This is because the law of superposition applies to electric fields, which are linear, allowing Gauss' Law to hold for systems with multiple charges. Hence, this statement is also correct.

Option C: An elementary patch on the enclosing surface is a polar vector.

The vector $d\vec{S}$ represents an infinitesimal area element on the surface, with the direction of the vector normal (perpendicular) to the surface. A normal vector to a surface is considered a polar vector because its properties do not change under a coordinate inversion. Therefore, this statement is correct.

Option D: An elementary patch on the enclosing surface is a pseudo-vector.

A pseudo-vector (or axial vector) is a vector that changes sign under inversion of the coordinate system (like angular momentum or magnetic field). The normal vector to a surface element does not change sign under inversion; hence, it is not a pseudo-vector but a polar vector. Thus, this statement is incorrect.

Therefore the correct statements are: Option A, Option B, and Option C.

Question 153

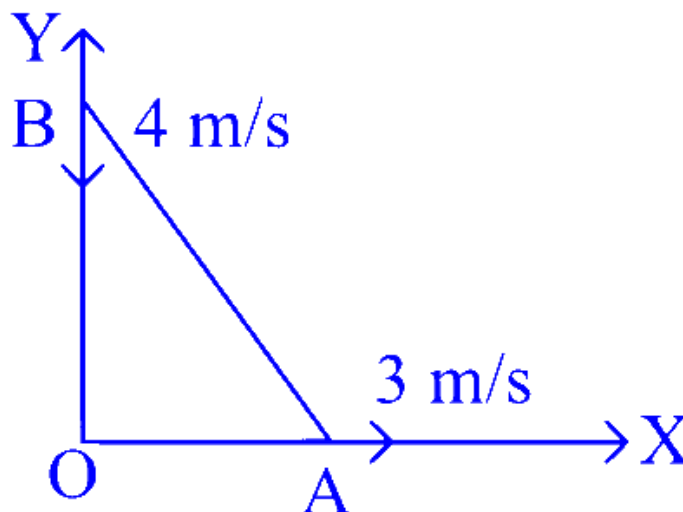

A uniform rod AB of length 1 m and mass 4 kg is sliding along two mutually perpendicular frictionless walls OX and OY. The velocity of the two ends of the

rod A and B are 3 m/s and 4 m/s respectively, as shown in the figure. Then which of the following statement(s) is/are correct?

Options:

A.

The velocity of the centre of mass of the rod is 2.5 m/s.

B.

Rotational kinetic energy of the rod is $\frac{25}{6}$ joule.

C.

The angular velocity of the rod is 5 rad/s clockwise.

D.

The angular velocity of the rod is 5 rad/s anticlockwise.

Answer: A

Solution:

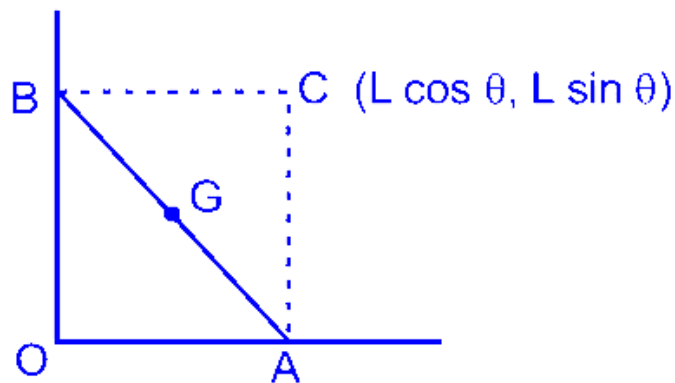

$$\omega = \frac{v_A}{CA} = \frac{v_B}{CB}$$

$$\omega^2 = \frac{v_A^2}{CA^2} = \frac{v_B^2}{CB^2} = \frac{v_A^2 + v_B^2}{L^2} = \frac{3^2 + 4^2}{1^2}$$

$$\omega = 5 \text{ rad/s} \Rightarrow (D)$$

$$CG = \frac{1}{2}, \quad \omega = \frac{v_G}{CG}, \quad v_G = 2.5 \text{ m/s} \Rightarrow (A)$$

$$\frac{1}{2} I_c \omega^2 = \frac{1}{2} \left[\frac{1}{12} mL^2 + m \left(\frac{L}{2} \right)^2 \right] \omega^2$$

$$= \frac{1}{2} \left(\frac{1}{3} mL^2 \right) \omega^2$$

$$= \frac{1}{6} mL^2 \omega^2$$

$$= \frac{1}{6} \times 4 \times 1^2 \times 25 = \frac{50}{3} \text{ J}$$

$$\frac{1}{2} mv_G^2 = \frac{1}{2} \times 4 \times \frac{25}{4} = \frac{25}{2} \text{ J}$$

$$\frac{50}{3} - \frac{25}{2} = \frac{100 - 75}{6} = \frac{25}{6} \text{ J} \Rightarrow (B)$$

Question 154

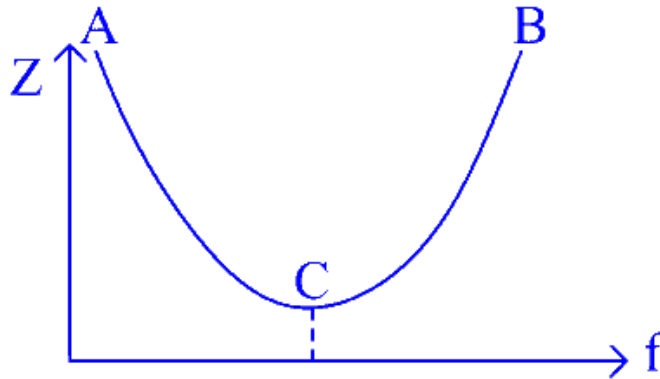

The variation of impedance Z of a series LCR circuit with frequency of the source is shown in the figure. Which of the following statement(s) is/are true ?

Options:

A.

The impedance Z is inductive in the portion AC

B.

The impedance Z is capacitive in the portion BC

C.

The impedance Z is inductive in the portion BC

D.

The impedance Z is capacitive in the portion AC

Answer: C

Question 155

The electric field of a plane electromagnetic wave in a medium is given by

$$\vec{E}(x, y, z, t) = E_0 \hat{n} e^{ik_o[(x+y+z)-ct]}$$

where c is the speed of light in free space. \vec{E} field is polarized in the $x - z$ plane. The speed of wave is v in the medium. Then

Options:

A.

$$\hat{n} = \hat{i} - \hat{k}; v = c.$$

B.

$$\hat{n} = \frac{\hat{i}-\hat{k}}{\sqrt{2}}; v = \frac{c}{\sqrt{3}}.$$

C.

refractive index of the medium is $\sqrt{3}$.

D.

$$\hat{n} = \frac{\hat{i}+\hat{k}}{\sqrt{2}}; v = \frac{c}{\sqrt{2}}.$$

Answer: B

Solution:

The given electric field is:

$$\vec{E}(x, y, z, t) = E_0 \hat{n} e^{ik_o[(x+y+z)-ct]}$$

We can rewrite this as:

$$\vec{E}(x, y, z, t) = E_0 \hat{n} e^{ik_o[(\hat{i}+\hat{j}+\hat{k})\cdot\vec{r}-ct]}$$

where $\vec{r} = x\hat{i} + y\hat{j} + z\hat{k}$ is the position vector. This represents a plane wave propagating in the direction of $\hat{i} + \hat{j} + \hat{k}$.

The wave vector is given by:

$$\vec{k} = k_o(\hat{i} + \hat{j} + \hat{k})$$

The magnitude of the wave vector is:

$$k = |\vec{k}| = k_o\sqrt{3}$$

The speed of the wave in the medium is given by:

$$v = \frac{\omega}{k} = \frac{ck_0}{k_0\sqrt{3}} = \frac{c}{\sqrt{3}}$$

The refractive index of the medium is given by:

$$n = \frac{c}{v} = \sqrt{3}$$

Since the electric field is polarized in the $x - z$ plane, the polarization vector \hat{n} must be a linear combination of \hat{i} and \hat{k} . To ensure the polarization is in the $x - z$ plane, and considering the wave is propagating along $\hat{i} + \hat{j} + \hat{k}$, the polarization vector must be perpendicular to the direction of propagation. Thus:

$$\hat{n} = \frac{\hat{i} - \hat{k}}{\sqrt{2}}$$

Therefore, the correct options are:

Option B: $\hat{n} = \frac{\hat{i} - \hat{k}}{\sqrt{2}}; v = \frac{c}{\sqrt{3}}$.

Option C: Refractive index of the medium is $\sqrt{3}$.
