



collegebatch.com

click to campus

MHT CET 2020 Question Paper with Solution

Maharashtra Common Entrance Test

Download more MHT CET Previous Year Question Papers: [Click Here](#)

# MHT-CET 2020

## General Instructions

- This question booklet contains 150 Multiple Choice Questions (MCQs).  
**Section-A:** Physics & Chemistry - 50 Questions each and  
**Section-B:** Mathematics - 50 Questions.
- Choice and sequence for attempting questions will be as per the convenience of the candidate.
- Read each question carefully.
- Determine the one correct answer out of the four available options given for each question.
- Each question with correct response shall be awarded one (1) mark. There shall be no negative marking.
- No mark shall be granted for marking two or more answers of same question, scratching or overwriting.
- Duration of paper is 3 Hours.

## SECTION-A

### PHYSICS

- For the same cross-sectional area and for a given load, the ratio of depressions for the beam of a square cross-section and circular cross-section is  
(a)  $3:\pi$  (b)  $\pi:3$  (c)  $1:\pi$  (d)  $\pi:1$
- If three equal masses  $m$  are placed at the three vertices of an equilateral triangle of side  $1/m$  then what force acts on a particle of mass  $2m$  placed at the centroid?  
(a)  $Gm^2$  (b)  $2Gm^2$  (c) Zero (d)  $-Gm^2$
- In a reverse biased diode when the applied voltage changes by 1 V, the current is found to change by  $0.5 \mu\text{A}$ . The reverse bias resistance of the diode is  
(a)  $2 \times 10^5 \text{ W}$  (b)  $2 \times 10^6 \text{ W}$   
(c)  $200 \Omega$  (d)  $2 \Omega$
- Two simple harmonic motions are represented by the equations  $y_1 = 0.1 \sin \left( 100\pi t + \frac{\pi}{3} \right)$  and  $y_2 = 0.1 \cos \pi t$ .  
The phase difference of the velocity of particle 1 with respect to the velocity of particle 2 is  
(a)  $\frac{\pi}{3}$  (b)  $-\frac{\pi}{6}$  (c)  $\frac{\pi}{6}$  (d)  $-\frac{\pi}{3}$
- A stretched wire 60 cm long is vibrating with its fundamental frequency of 256 Hz. If the length of the wire is decreased to 15 cm and the tension remains the same. Then the fundamental frequency of the vibration of the wire will be  
(a) 1024 (b) 572  
(c) 256 (d) 64
- A soap film of surface tension  $3 \times 10^{-2}$  formed in a rectangular frame can support a straw as shown in Fig. If  $g = 10 \text{ ms}^{-2}$ , the mass of the straw is  
(a) 0.006 g (b) 0.06 g  
(c) 0.6 g (d) 6 g
- A circular disc of radius  $R$  is removed from a bigger circular disc of radius  $2R$  such that the circumferences of the discs coincide. The centre of mass of the new disc is  $\alpha/R$  from the centre of the bigger disc. The value of  $\alpha$  is  
(a)  $1/4$  (b)  $1/3$   
(c)  $1/2$  (d)  $1/6$

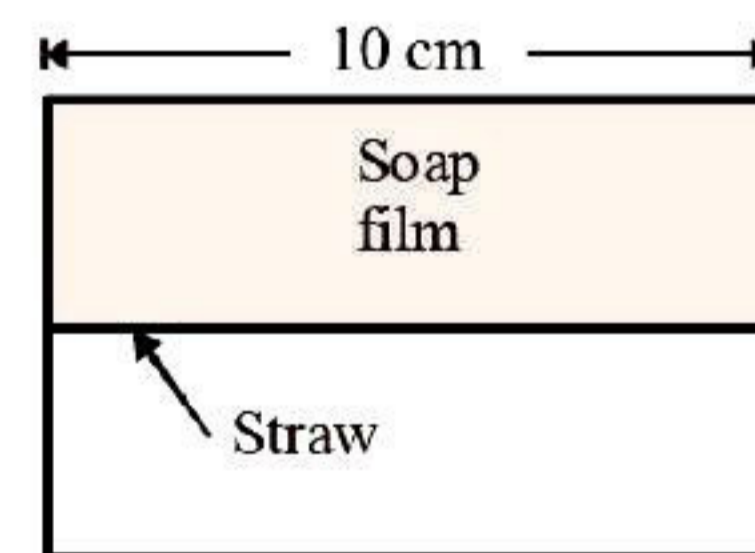

8. Two sources of equal emf are connected to an external resistance  $R$ . The internal resistance of the two sources are  $R_1$  and  $R_2$  ( $R_2 > R_1$ ). If the potential difference across the source having internal resistance  $R_2$  is zero, then

- (a)  $R = R_2 - R_1$   
 (b)  $R = R_2 \times (R_1 + R_2) / (R_2 - R_1)$   
 (c)  $R = R_1 R_2 / (R_2 - R_1)$   
 (d)  $R = R_1 R_2 / (R_1 - R_2)$

9. A vessel contains oil (density =  $0.8 \text{ gm/cm}^3$ ) over mercury (density =  $13.6 \text{ gm/cm}^3$ ). A homogeneous sphere floats with half of its volume immersed in mercury and the other half in oil. The density of the material of the sphere in  $\text{gm/cm}^3$  is

- (a) 3.3      (b) 6.4      (c) 7.2      (d) 12.8

10. A current of  $I$  ampere flows in a wire forming a circular arc of radius  $r$  metres subtending an angle  $\theta$  at the centre as shown. The magnetic field at the centre  $O$  in tesla is

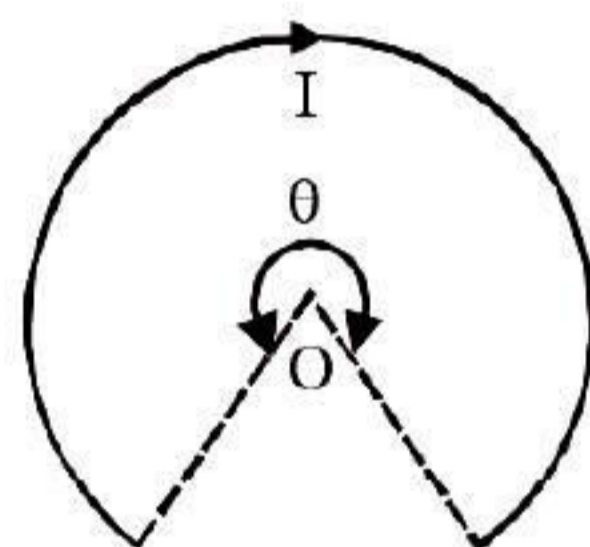

- (a)  $\frac{\mu_0 I \theta}{4\pi r}$       (b)  $\frac{\mu_0 I \theta}{2\pi r}$   
 (c)  $\frac{\mu_0 I \theta}{2r}$       (d)  $\frac{\mu_0 I \theta}{4r}$

11. A broadcast radio transmitter radiates 12 kW when percentage of modulation is 50%, then the unmodulated carrier power is

- (a) 5.67 kW      (b) 7.15 kW  
 (c) 9.6 kW      (d) 12 kW

12. Two trains are moving towards each other with speeds of 20 m/s and 15 m/s relative to the ground. The first train sounds a whistle of frequency 600 Hz. The frequency of the whistle heard by a passenger in the second train before the train meets, is (the speed of sound in air is 340 m/s)

- (a) 600 Hz      (b) 585 Hz  
 (c) 645 Hz      (d) 666 Hz

13. A particle of mass  $M$  is situated at the centre of a spherical shell of same mass and radius  $a$ . The gravitational potential at a point situated at  $\frac{a}{2}$  distance from the centre, will be:

- (a)  $-\frac{3GM}{a}$       (b)  $-\frac{2GM}{a}$   
 (c)  $-\frac{GM}{a}$       (d)  $-\frac{4GM}{a}$

14. For a particle executing SHM the displacement  $x$  is given by  $x = A \cos \omega t$ . Identify the graph which represents the variation of potential energy (P.E.) as a function of time  $t$  and displacement  $x$ .

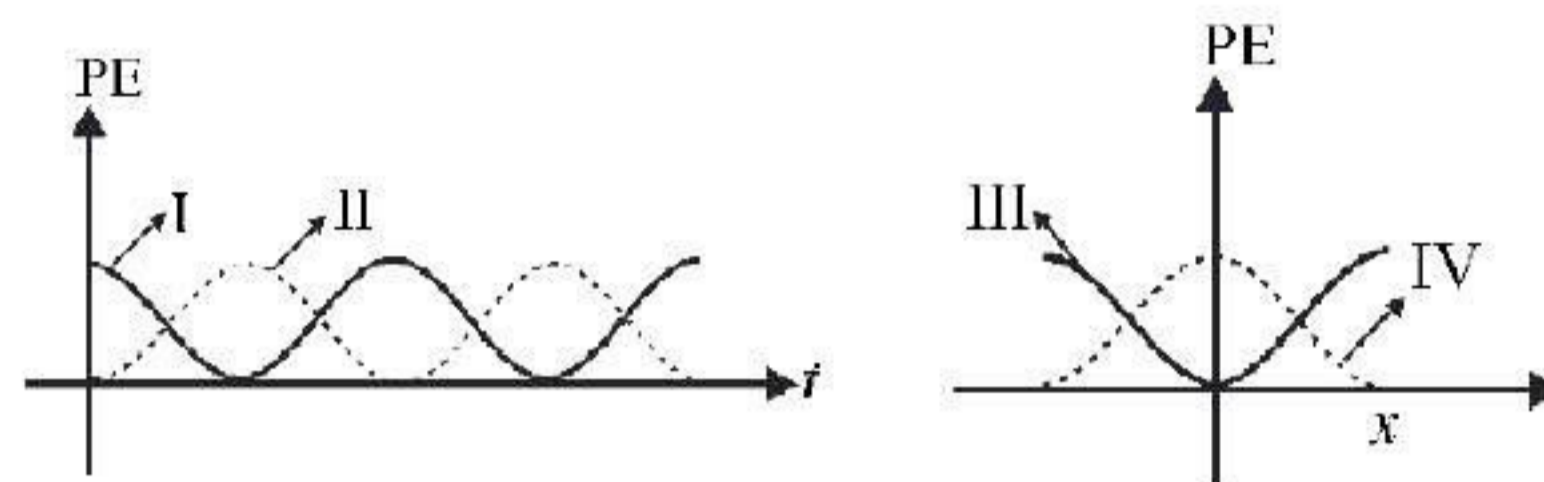

- (a) I, III      (b) II, IV  
 (c) II, III      (d) I, IV

15. A beam of electrons is moving with constant velocity in a region having simultaneous perpendicular electric and magnetic fields of strength  $20 \text{ Vm}^{-1}$  and  $0.5 \text{ T}$  respectively at right angles to the direction of motion of the electrons. Then the velocity of electrons must be

- (a) 8 m/s      (b) 20 m/s  
 (c) 40 m/s      (d)  $\frac{1}{40} \text{ m/s}$

16. The period of oscillation of a magnet in a vibration magnetometer is 2 sec. The period of oscillation of a magnet whose magnetic moment is four times that of the first magnet is

- (a) 1 sec      (b) 5 sec  
 (c) 8 sec      (d) 0.5 sec

17. A cell having an emf  $\varepsilon$  and internal resistance  $r$  is connected across a variable external resistance  $R$ . As the resistance  $R$  is increased, the plot of potential difference  $V$  across  $R$  is given by

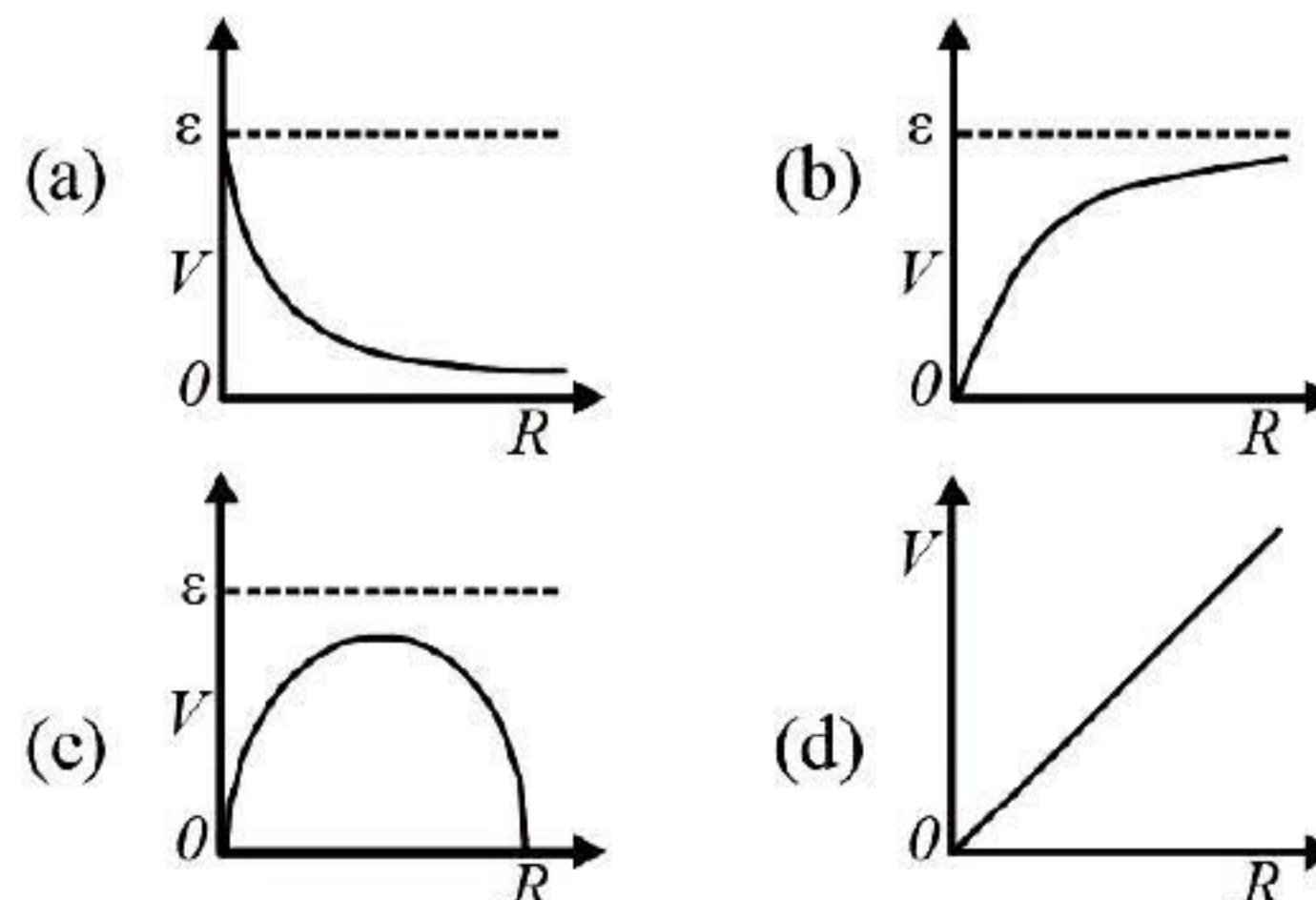

18. The transition from the state  $n = 4$  to  $n = 3$  in a hydrogen like atom results in ultraviolet radiation. Infrared radiation will be obtained in the transition from
- (a)  $2 \rightarrow 1$                       (b)  $3 \rightarrow 2$   
(c)  $4 \rightarrow 2$                       (d)  $5 \rightarrow 4$
19. A light rod of length  $2m$  suspended from the ceiling horizontally by means of two vertical wires of equal length. A weight  $W$  is hung from a light rod as shown in figure.

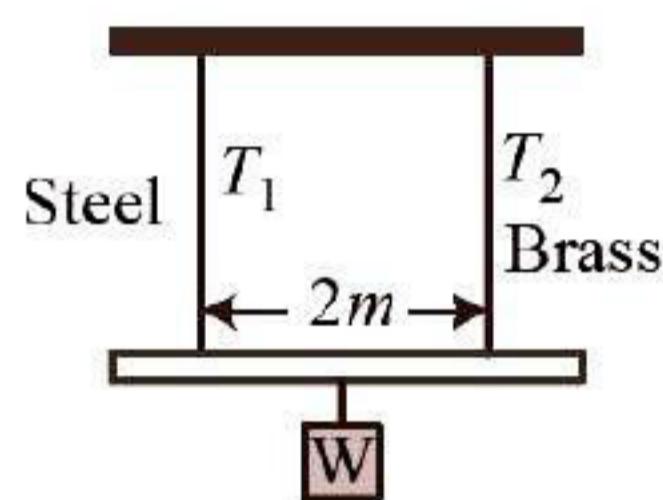

The rod hung by means of a steel wire of cross-sectional area  $A_1 = 0.1 \text{ cm}^2$  and brass wire of cross-sectional area  $A_2 = 0.2 \text{ cm}^2$ . To have equal stress in both wires,  $T_1/T_2 =$

- (a)  $1/3$     (b)  $1/4$     (c)  $4/3$     (d)  $1/2$
20. For which angle between two equal vectors  $\vec{A}$  and  $\vec{B}$  will the magnitude of the sum of two vectors be equal to the magnitude of each vector?
- (a)  $\theta = 60^\circ$                       (b)  $\theta = 120^\circ$   
(c)  $\theta = 0^\circ$                       (d)  $\theta = 90^\circ$
21. The width of a slit is  $0.012 \text{ mm}$ . Monochromatic light is incident on it. The angular position of first bright line is  $5.2^\circ$ . The wavelength of incident light is  $[\sin 5.2^\circ = 0.0906]$ .
- (a)  $6040 \text{ \AA}$                       (b)  $4026 \text{ \AA}$   
(c)  $5890 \text{ \AA}$                       (d)  $7248 \text{ \AA}$
22. The least coefficient of friction for an inclined plane inclined at angle  $\alpha$  with horizontal in order that a solid cylinder will roll down without slipping is
- (a)  $\frac{2}{3} \tan \alpha$                       (b)  $\frac{2}{7} \tan \alpha$   
(c)  $\tan \alpha$                       (d)  $\frac{5}{7} \tan \alpha$
23. Two balls are projected at an angle  $\theta$  and  $(90^\circ - \theta)$  to the horizontal with the same speed. The ratio of their maximum vertical heights is
- (a)  $1 : 1$                       (b)  $\tan \theta : 1$   
(c)  $1 : \tan \theta$                       (d)  $\tan^2 \theta : 1$

24. A rod PQ of mass  $M$  and length  $L$  is hinged at end P. The rod is kept horizontal by a massless string tied to point Q as shown in figure. When string is cut, the initial angular acceleration of the rod is

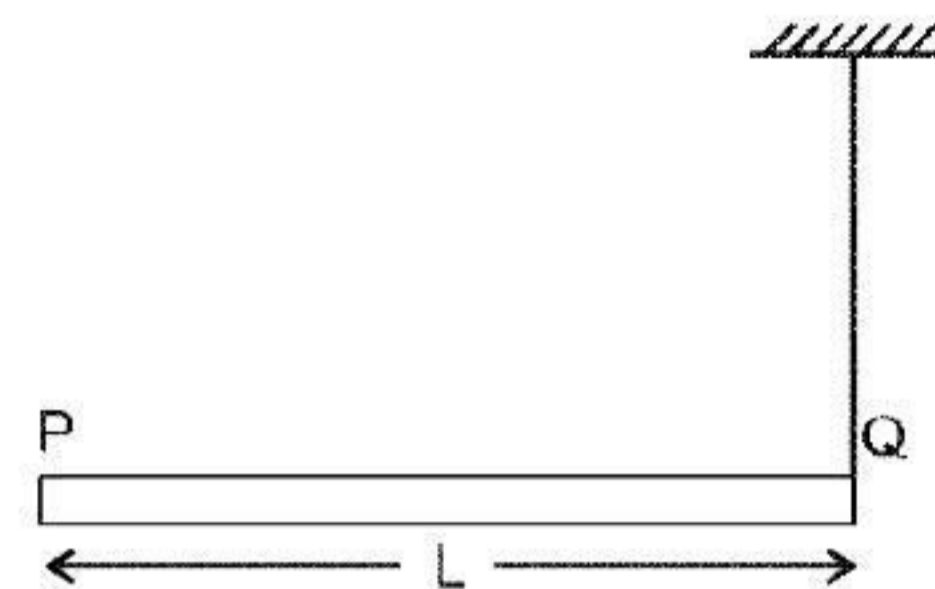

- (a)  $g/L$   
(b)  $2g/L$   
(c)  $\frac{2g}{3L}$   
(d)  $\frac{3g}{2L}$
25. Let  $Q$  denote the charge on the plate of a capacitor of capacitance  $C$ . The dimensional formula for  $\frac{Q^2}{C}$  is
- (a)  $[L^2M^2T]$                       (b)  $[LMT^2]$   
(c)  $[L^2MT^{-2}]$                       (d)  $[L^2M^2T^2]$
26. A common emitter amplifier has a voltage gain of 50, an input impedance of  $100\Omega$  and an output impedance of  $200\Omega$ . The power gain of the amplifier is
- (a) 500    (b) 1000    (c) 1250    (d) 50
27. A glass flask is filled up to a mark with  $50 \text{ cc}$  of mercury at  $18^\circ\text{C}$ . If the flask and contents are heated to  $38^\circ\text{C}$ , how much mercury will be above the mark? ( $\alpha$  for glass is  $9 \times 10^{-6}/^\circ\text{C}$  and coefficient of real expansion of mercury is  $180 \times 10^{-6}/^\circ\text{C}$ )
- (a)  $0.85 \text{ cc}$                       (b)  $0.46 \text{ cc}$   
(c)  $0.153 \text{ cc}$                       (d)  $0.05 \text{ cc}$
28. With the increase in temperature, the angle of contact
- (a) decreases  
(b) increases  
(c) remains constant  
(d) sometimes increases and sometimes decreases
29. A prism has a refracting angle of  $60^\circ$ . When placed in the position of minimum deviation, it produces a deviation of  $30^\circ$ . The angle of incidence is
- (a)  $30^\circ$     (b)  $45^\circ$     (c)  $15^\circ$     (d)  $60^\circ$
30. A planet in a distant solar system is 10 times more massive than the earth and its radius is 10 times smaller. Given that the escape velocity from the earth's surface is  $11 \text{ km s}^{-1}$ , the escape velocity from the surface of the planet would be
- (a)  $1.1 \text{ km s}^{-1}$                       (b)  $11 \text{ km s}^{-1}$   
(c)  $110 \text{ km s}^{-1}$                       (d)  $0.11 \text{ km s}^{-1}$

31. The fringe width in a Young's double slit experiment can be increased if we decrease  
 (a) width of slits  
 (b) separation of slits  
 (c) wavelength of light used  
 (d) distance between slits and screen
32. Two radiations of photons energies 1 eV and 2.5 eV, successively illuminate a photosensitive metallic surface of work function 0.5 eV. The ratio of the maximum speeds of the emitted electrons is  
 (a) 1:4 (b) 1:2 (c) 1:1 (d) 1:5
33. An electromagnetic wave going through vacuum is described by  $E = E_0 \sin(kx - \omega t)$ ;  $B = B_0 \sin(kx - \omega t)$ . Which of the following equations is true?  
 (a)  $E_0 k = B_0 \omega$  (b)  $E_0 \omega = B_0 k$   
 (c)  $E_0 B_0 = \omega k$  (d) None of these
34. A galvanometer of resistance  $100 \Omega$  gives a full scale deflection for a current of  $10^{-5}$  A. To convert it into an ammeter capable of measuring upto 1 A, we should connect a resistance of  
 (a)  $1 \Omega$  in parallel (b)  $10^{-3} \Omega$  in parallel  
 (c)  $10^5 \Omega$  in series (d)  $100 \Omega$  in series
35. A spherical ball of iron of radius 2 mm is falling through a column of glycerine. If densities of glycerine and iron are respectively  $1.3 \times 10^3 \text{ kg/m}^3$  and  $8 \times 10^3 \text{ kg/m}^3$ .  $\eta$  for glycerine =  $0.83 \text{ Nm}^{-2} \text{ sec}$ , then the terminal velocity is  
 (a) 0.7 m/s (b) 0.07 m/s  
 (c) 0.007 m/s (d) 0.0007 m/s
36. A Carnot engine whose low temperature reservoir is at  $7^\circ\text{C}$  has an efficiency of 50%. It is desired to increase the efficiency to 70%. By how many degrees should the temperature of the high temperature reservoir be increased?  
 (a) 840 K (b) 280 K (c) 560 K (d) 380 K
37. The two blocks,  $m = 10 \text{ kg}$  and  $M = 50 \text{ kg}$  are free to move as shown. The coefficient of static friction between the blocks is 0.5 and there is no friction between  $M$  and the ground. A minimum horizontal force  $F$  is applied to hold  $m$  against  $M$  that is equal to

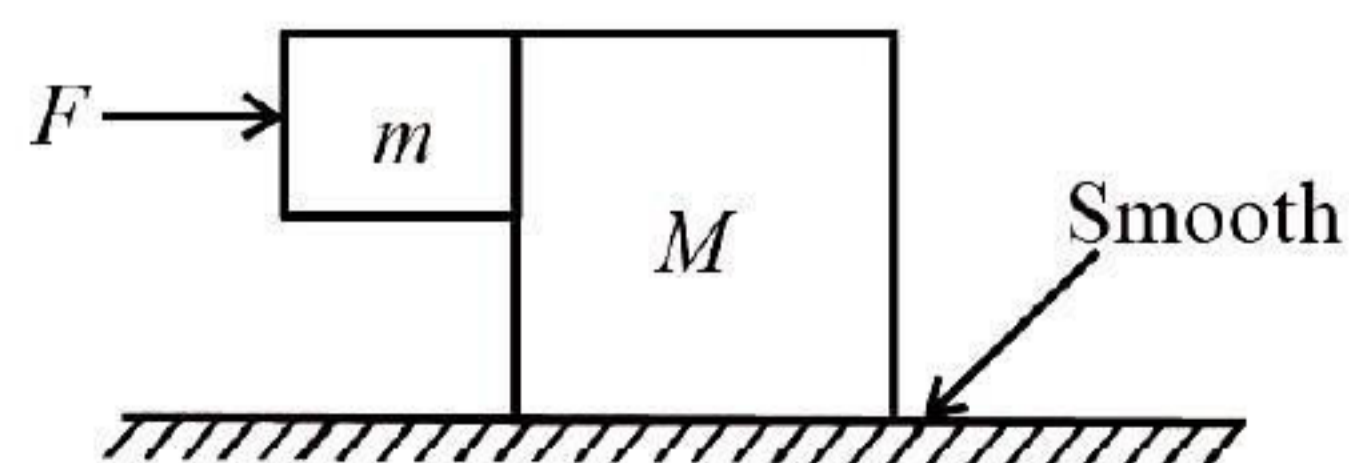

- (a) 100 N (b) 50 N (c) 240 N (d) 180 N

38. The pressure on a square plate is measured by measuring the force on the plate and length of the sides of the plate by using the formula  $P = \frac{F}{\ell^2}$ . If the maximum errors in the measurement of force and length are 6% and 3% respectively, then the maximum error in the measurement of pressure is  
 (a) 1% (b) 2% (c) 12% (d) 10%
39. An electron of mass  $m$  and charge  $e$  initially at rest gets accelerated by a constant electric field  $E$ . The rate of change of de-Broglie wavelength of this electron at time  $t$  ignoring relativistic effects is  
 (a)  $\frac{-h}{eEt^2}$  (b)  $\frac{-eht}{E}$   
 (c)  $\frac{-mh}{eEt^2}$  (d)  $\frac{-h}{eE}$
40. A plano-convex lens is made of material of refractive index 1.6. The radius of curvature of the curved surface is 60 cm. The focal length of the lens is  
 (a) 50 cm (b) 100 cm  
 (c) 200 cm (d) 400 cm
41. A mass  $m$  is revolving in a vertical circle at the end of a string of length 20 cm. By how much does the tension of the string at the lowest point exceed the tension at the topmost point?  
 (a) 2 mg (b) 4 mg (c) 6 mg (d) 8 mg
42. Two conducting circular loops of radii  $R_1$  and  $R_2$  are placed in the same plane with their centres coinciding. If  $R_1 \gg R_2$ , the mutual inductance  $M$  between them will be directly proportional to  
 (a)  $R_1/R_2$  (b)  $R_2/R_1$   
 (c)  $R_1^2/R_2$  (d)  $R_2^2/R_1$
43. If  $x = at + bt^2$ , where  $x$  is the distance travelled by the body in kilometers while  $t$  is the time in seconds, then the unit of  $b$  is  
 (a) km/s (b) kms  
 (c)  $\text{km/s}^2$  (d)  $\text{kms}^2$
44. An organ pipe  $P_1$  closed at one end vibrating in its first overtone and another pipe  $P_2$  open at both ends vibrating in third overtone are in resonance with a given tuning fork. The ratio of the length of  $P_1$  to that of  $P_2$  is  
 (a)  $8/3$  (b)  $3/8$  (c)  $1/2$  (d)  $1/3$

45. If one mole of monoatomic gas ( $\gamma = \frac{5}{3}$ ) is mixed with one mole of diatomic gas ( $\gamma = \frac{7}{5}$ ), the value of  $\gamma$  for the mixture is  
 (a) 1.40 (b) 1.50 (c) 1.53 (d) 3.07
46. In a series resonant circuit, having L, C and R as its elements, the resonant current is  $i$ . The power dissipated in circuit at resonance is

- (a)  $\frac{i^2 R}{(\omega L - 1/\omega C)}$  (b) zero  
 (c)  $i^2 \omega L$  (d)  $i^2 R$

Whereas  $\omega$  is angular resonant frequency

47. A U-tube is of non uniform cross-section. The area of cross-sections of two sides of tube are  $A$  and  $2A$  (see fig.). It contains non-viscous liquid of mass  $m$ . The liquid is displaced slightly and free to oscillate. Its time period of oscillations is

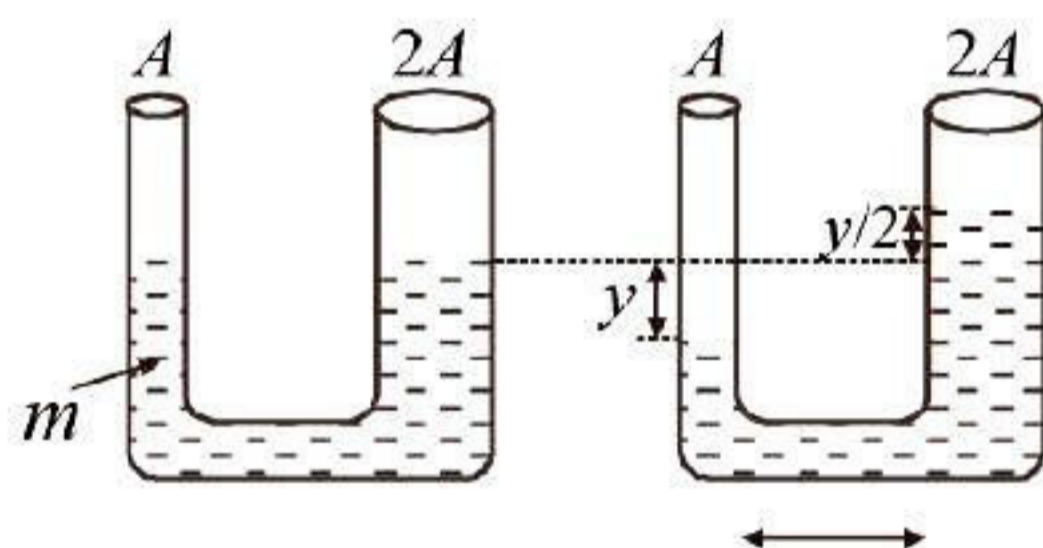

- (a)  $T = 2\pi \sqrt{\frac{m}{3\rho g A}}$  (b)  $T = 2\pi \sqrt{\frac{m}{2\rho g A}}$   
 (c)  $T = 2\pi \sqrt{\frac{m}{\rho g A}}$  (d) None of these
48. From a supply of identical capacitors rated 8 mF, 250V, the minimum number of capacitors required to form a composite 16 mF, 1000V is  
 (a) 2 (b) 4 (c) 16 (d) 32
49. An  $\alpha$ -particle of energy 5 MeV is scattered through  $180^\circ$  by a fixed uranium nucleus. The distance of closest approach is of the order of  
 (a)  $10^{-12}$  cm (b)  $10^{-10}$  cm  
 (c)  $10^{-20}$  cm (d)  $10^{-15}$  cm
50. A moving coil galvanometer has  $N$  number of turns in a coil of effective area  $A$ , it carries a current  $I$ . The magnetic field  $B$  is radial. The torque acting on the coil is  
 (a)  $NA^2 B^2 I$  (b)  $NAB I^2$   
 (c)  $N^2 ABI$  (d)  $NABI$

## CHEMISTRY

51.  $KO_2$  (potassium super oxide) is used in oxygen cylinders in space and submarines because it  
 (a) absorbs  $CO_2$  and increases  $O_2$  content  
 (b) eliminates moisture  
 (c) absorbs  $CO_2$   
 (d) produces ozone.
52. Which of the following is a bactericidal antibiotic?  
 (a) Ofloxacin (b) Tetracycline  
 (c) Chloramphenicol (d) Erythromycin
53. An ideal gas expands against a constant external pressure of 2.0 atmosphere from 20 litre to 40 litre and absorbs 10 kJ of heat from surrounding. What is the change in internal energy of the system? (given : 1 atm-litre = 101.3 J)  
 (a) 4052 J (b) 5948 J  
 (c) 14052 J (d) 9940 J
54. In a solution of  $CuSO_4$  how much time will be required to precipitate 2 g copper by 0.5 ampere current?  
 (a) 12157.48 sec (b) 102 sec  
 (c) 510 sec (d) 642 sec
55. Which of the following compounds will undergo self aldol condensation in the presence of cold dilute alkali?  
 (a)  $CH_2 = CH - CHO$  (b)  $CH \equiv C - CHO$   
 (c)  $C_6H_5CHO$  (d)  $CH_3CH_2CHO$
56. An element having an atomic radius of 0.14 nm crystallizes in an fcc unit cell. What is the length of a side of the cell?  
 (a) 0.56 nm (b) 0.24 nm  
 (c) 0.96 nm (d) 0.4 nm
57. 120 g of an ideal gas of molecular weight 40 g  $mol^{-1}$  are confined to a volume of 20 L at 400 K. Using  $R = 0.0821$  L atm  $K^{-1}$   $mol^{-1}$ , the pressure of the gas is  
 (a) 4.90 atm (b) 4.92 atm  
 (c) 5.02 atm (d) 4.96 atm

58. Fluorobenzene ( $C_6H_5F$ ) can be synthesized in the laboratory

- (a) by direct fluorination of benzene with  $F_2$  gas  
 (b) by reacting bromobenzene with NaF solution  
 (c) by heating phenol with HF and KF  
 (d) from aniline by diazotisation followed by heating the diazonium salt with  $HBF_4$

59. Substance used for the preservation of coloured fruit juices is

- (a) benzene  
 (b) benzoic acid  
 (c) phenol  
 (d) sodium meta bisulphite

60. Which of the following compounds gives dye test?

- (a) Aniline (b) Methylamine  
 (c) Diphenylamine (d) Ethylamine

61. The correct statement with regard to  $H_2^+$  and  $H_2^-$  is

- (a) Both  $H_2^+$  and  $H_2^-$  do not exist  
 (b)  $H_2^-$  is more stable than  $H_2^+$   
 (c)  $H_2^+$  is more stable than  $H_2^-$   
 (d) Both  $H_2^+$  and  $H_2^-$  are equally stable

62. 18 g of glucose ( $C_6H_{12}O_6$ ) is added to 178.2 g of water. The vapour pressure of water for this aqueous solution is

- (a) 76.00 torr (b) 752.40 torr  
 (c) 759.00 torr (d) 7.60 torr

63. Mark the oxide which is amphoteric in character

- (a)  $CO_2$  (b)  $SiO_2$  (c)  $SnO_2$  (d)  $CaO$

64. The standard EMF for the cell reaction,

$Zn + Cu^{2+} \longrightarrow Cu + Zn^{2+}$  is 1.1 volt at  $25^\circ C$ . The EMF for the cell reaction, when 0.1 M  $Cu^{2+}$  and 0.1 M  $Zn^{2+}$  solutions are used, at  $25^\circ C$  is

- (a) 1.10V (b) 0.10V  
 (c) -1.10V (d) -0.110V

65. The reactant (X) in the reaction

(X)  $\xrightarrow{(CH_3CO)_2O} CH_3COONa$  Cinnamic acid, is

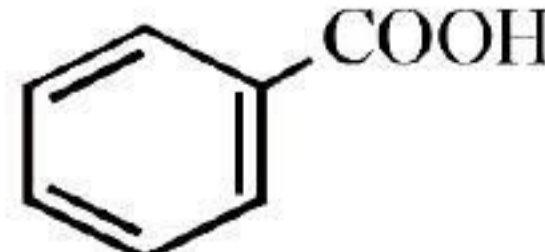
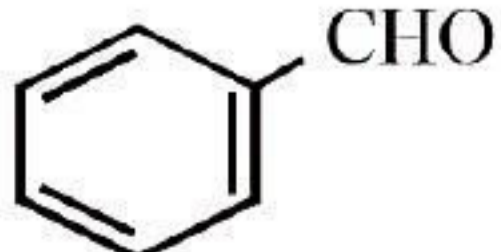
- (a)  (b) 

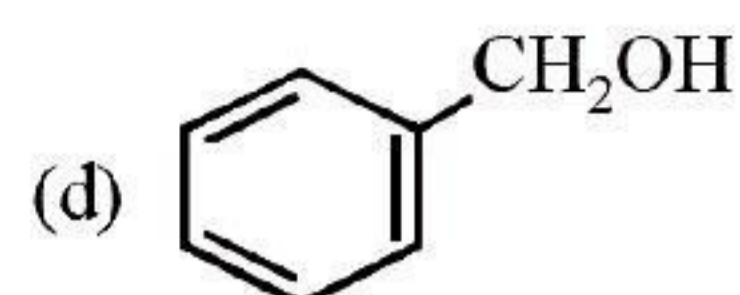
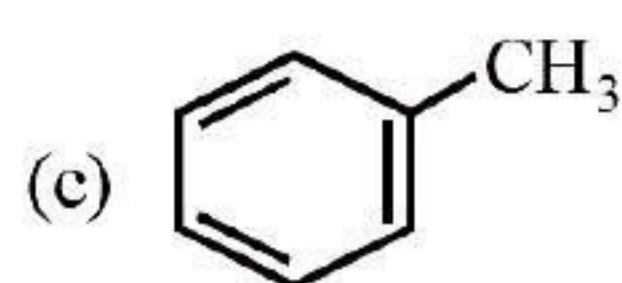

66. The brown ring complex is formulated as  $[Fe(H_2O)_5NO]SO_4$ . The oxidation number of iron is

- (a) 1 (b) 2 (c) 3 (d) 0

67. A substance  $C_4H_{10}O$  yields on oxidation a compound,  $C_4H_8O$  which gives an oxime and a positive iodoform test. The original substance on treatment with conc.  $H_2SO_4$  gives  $C_4H_8$ . The structure of the compound is

- (a)  $CH_3CH_2CH_2CH_2OH$   
 (b)  $CH_3CHOHCH_2CH_3$   
 (c)  $(CH_3)_3COH$   
 (d)  $CH_3CH_2-O-CH_2CH_3$

68. Number of moles of  $KMnO_4$  required to oxidize one mole of  $Fe(C_2O_4)$  in acidic medium is

- (a) 0.167 (b) 0.6 (c) 0.2 (d) 0.4

69. Predict the product C obtained in the following reaction of butyne-1.

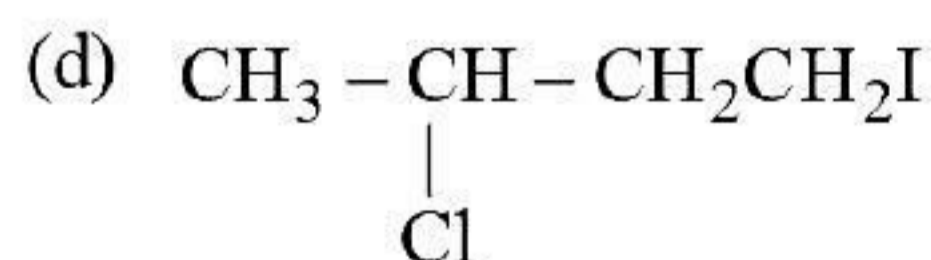
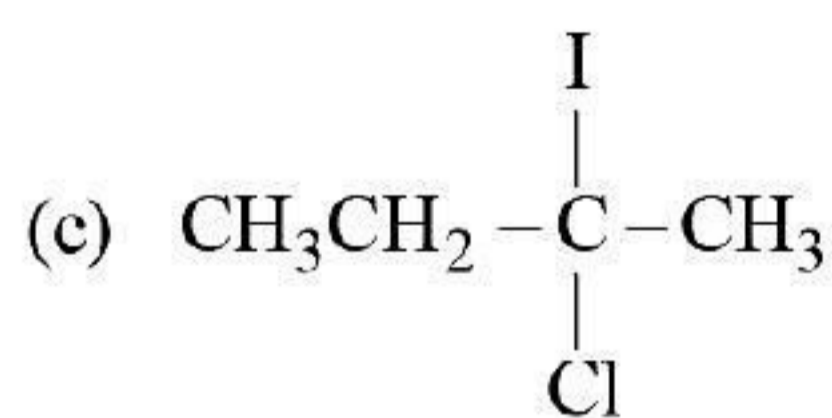
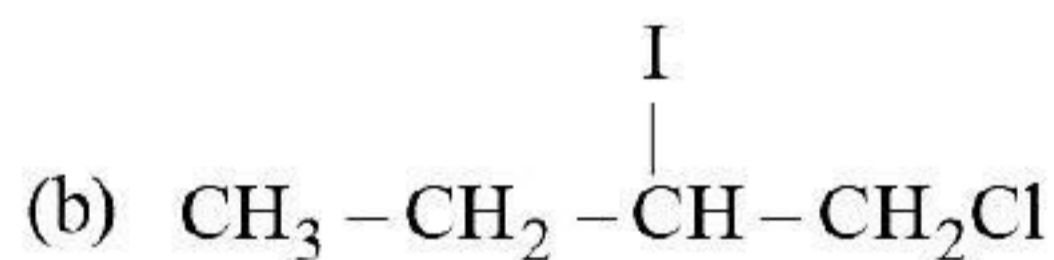
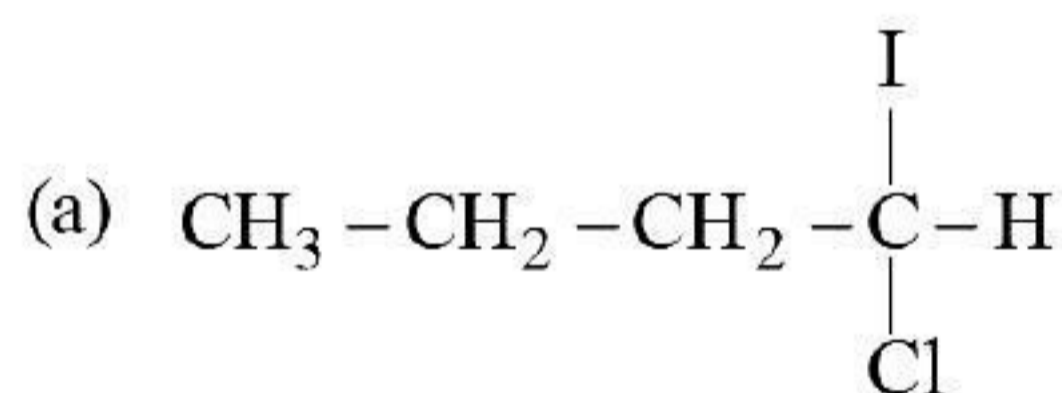
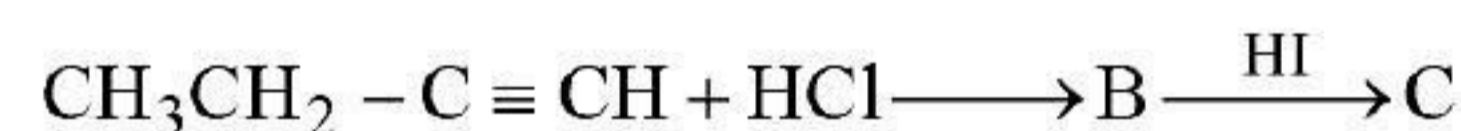

70. The vapour pressure of a solvent A is 0.80 atm. When a non-volatile substance B is added to this solvent its vapour pressure drops to 0.6 atm. the mole fraction of B in the solution is

- (a) 0.25 (b) 0.50 (c) 0.75 (d) 0.90

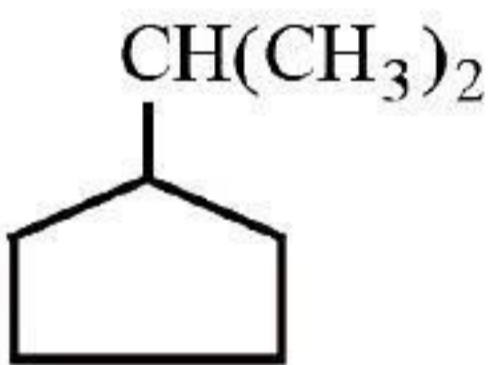
71. The electric cookers have a coating that protects them against fire. The coating is made of  
 (a) heavy lead (b) zinc oxide  
 (c) magnesium oxide (d) sodium sulphate
72. Chlorine is liberated when we heat  
 (a)  $\text{KMnO}_4 + \text{NaCl}$  (b)  $\text{K}_2\text{Cr}_2\text{O}_7 + \text{MnO}_2$   
 (c)  $\text{Pb}(\text{NO}_3)_2 + \text{MnO}_2$  (d)  $\text{K}_2\text{Cr}_2\text{O}_7 + \text{HCl}$
73. Which of the following solutions will have the maximum lowering of vapour pressure at 300 K  
 (a) 1 M  $\text{CaCl}_2$  (b) 1 M  $\text{NaCl}$   
 (c) 1 M Phenol (d) 1 M sucrose
74. Which of the following electrolyte will be most effective in coagulation of negative sol?  
 (a)  $\text{KNO}_3$  (b)  $\text{K}_4[\text{Fe}(\text{CN})_6]$   
 (c)  $\text{Na}_3\text{PO}_4$  (d)  $\text{MgCl}_2$
75. The element which has not yet been reacted with  $\text{F}_2$  is  
 (a) Ar (b) Xe (c) Kr (d) Rn
76. Which is the best oxidising agent among the following?  
 (a) S (b) O (c) Se (d) Te
77. Which of the following is correct for a first order reaction?  
 (a)  $t_{1/2} \propto a$  (b)  $t_{1/2} \propto 1/a$   
 (c)  $t_{1/2} \propto a^0$  (d)  $t_{1/2} \propto 1/a^2$
78. Standard enthalpy and standard entropy changes for the oxidation of ammonia at 298 K are  $-382.64 \text{ kJ mol}^{-1}$  and  $-145.6 \text{ JK}^{-1} \text{ mol}^{-1}$ , respectively. Standard Gibb's energy change for the same reaction at 298 K is  
 (a)  $-22.1 \text{ kJ mol}^{-1}$  (b)  $-339.3 \text{ kJ mol}^{-1}$   
 (c)  $-439.3 \text{ kJ mol}^{-1}$  (d)  $-523.2 \text{ kJ mol}^{-1}$
79. Which of the following polymers do not involve cross linkages?  
 (a) Melmac (b) Bakelite  
 (c) Polythene (d) Vulcanised rubber
80. When a metal is to be extracted from its ore and the gangue associated with the ore is silica, then  
 (a) an acidic flux is needed  
 (b) a basic flux is needed  
 (c) both acidic and basic fluxes are needed  
 (d) Neither of them is needed
81.  $\text{A} \rightarrow \text{B}$ ,  $\Delta H = -10 \text{ kJ mol}^{-1}$ ,  $E_{a(f)} = 50 \text{ kJ mol}^{-1}$ , then  $E_a$  of  $\text{B} \rightarrow \text{A}$  will be  
 (a)  $40 \text{ kJ mol}^{-1}$  (b)  $50 \text{ kJ mol}^{-1}$   
 (c)  $-50 \text{ kJ mol}^{-1}$  (d)  $60 \text{ kJ mol}^{-1}$
82. At anode in the electrolysis of fused  $\text{NaCl}$   
 (a)  $\text{Na}^+$  is oxidized (b)  $\text{Cl}^-$  is oxidized  
 (c) Cl is reduced (d) Na is reduced
83. Molarity of liquid  $\text{HCl}$  will be, if density of solution is  $1.17 \text{ g/cc}$   
 (a) 36.5 (b) 32.05  
 (c) 18.25 (d) 42.10
84. Which of the following bicarbonates does not exist as solid?  
 (a)  $\text{KHCO}_3$  (b)  $\text{NaHCO}_3$   
 (c)  $\text{CsHCO}_3$  (d)  $\text{LiHCO}_3$
85.  $\text{P}_2\text{O}_5$  is heated with water to give  
 (a) hypophosphorous acid  
 (b) phosphorous acid  
 (c) hypophosphoric acid  
 (d) orthophosphoric acid
86. What is the IUPAC name of the compound?  

- (a) 1, 1 – dimethyl – 1 – cyclopentyl methane  
 (b) 2 – cyclopentyl propane  
 (c) 1 – (1 – methyl) ethyl cyclopentane  
 (d) Cumene.
87. Which one of the following reactions is expected to readily give a hydrocarbon product in good yields?  
 (a)  $\text{RCOOK} \xrightarrow[\text{oxidation}]{\text{Electrolytic}}$   
 (b)  $\text{RCOO}^- \text{Ag}^+ \xrightarrow{\text{Br}_2}$   
 (c)  $\text{CH}_3\text{CH}_3 \xrightarrow[\text{h}\nu]{\text{Cl}_2}$   
 (d)  $(\text{CH}_3)_3\text{CCl} \xrightarrow{\text{C}_2\text{H}_5\text{OH}}$
88. Among the trihalides of nitrogen which one is most basic?  
 (a)  $\text{NF}_3$  (b)  $\text{NCl}_3$   
 (c)  $\text{NI}_3$  (d)  $\text{NBr}_3$

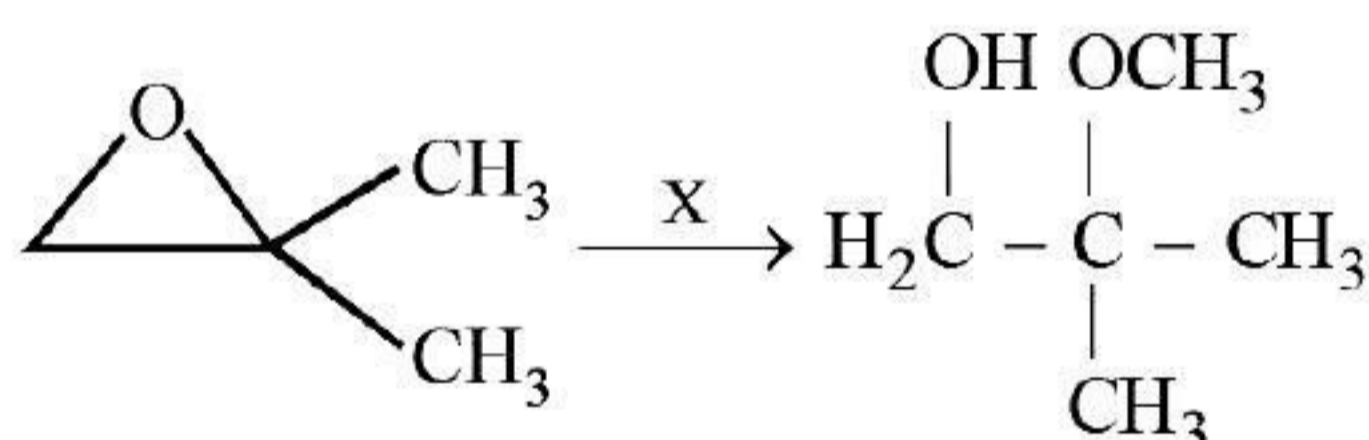

89. Omeprazole and lansoprazole are used as –  
 (a) antifertility (b) antiallergic  
 (c) antibiotic (d) antacid
90. Hydrolysis of sucrose is called  
 (a) hydration (b) saponification  
 (c) esterification (d) inversion
91. van Arkel method of purification of metals involves converting the metal to a  
 (a) volatile stable compound  
 (b) volatile unstable compound  
 (c) non volatile stable compound  
 (d) None of the above
92. When  $\text{SO}_2$  is passed through acidified solution of potassium dichromate, then chromium sulphate is formed. The change in valency of chromium is  
 (a) +4 to +2 (b) +5 to +3  
 (c) +6 to +3 (d) +7 to +2
93. Which of the following polymer is used for manufacturing of buckets, dustbins, pipes etc ?  
 (a) Low density polythene  
 (b) High density polythene  
 (c) Teflon  
 (d) Polyacrylonitrile
94. What is X in the following reaction ?

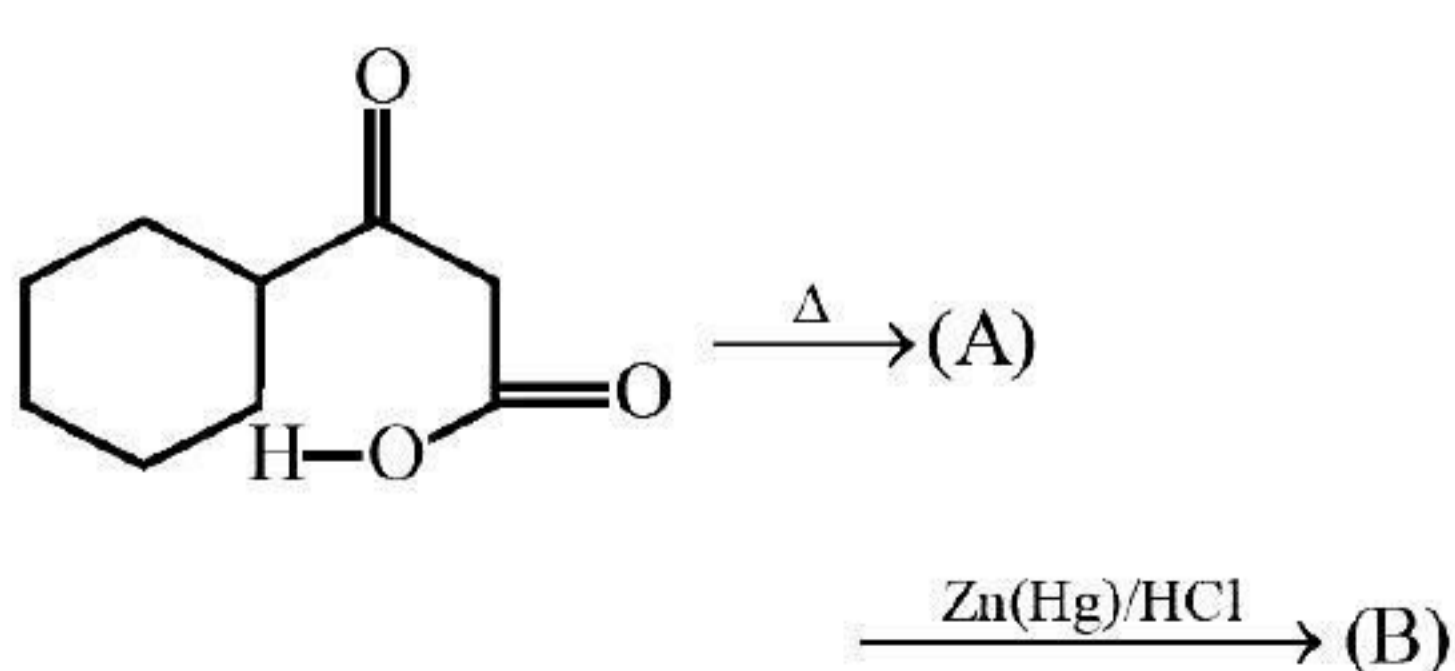

- (a)  $\text{CH}_3\text{OH}, \text{H}_2\text{SO}_4$   
 (b)  $\text{CH}_3\text{OH}, \text{CH}_3\text{O}^- \text{Na}^+$   
 (c)  $\text{H}_2\text{O} / \text{H}_2\text{SO}_4$  followed by  $\text{CH}_3\text{OH}$   
 (d)  $\text{CH}_3\text{MgBr}$  / ether followed by  $\text{H}_3\text{O}^+$
95. 

In the above reaction, product (B) is:

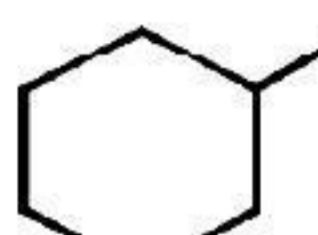
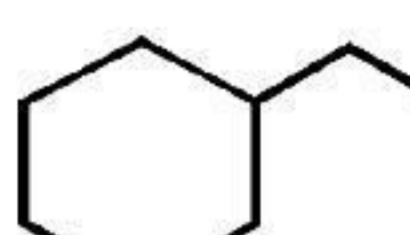
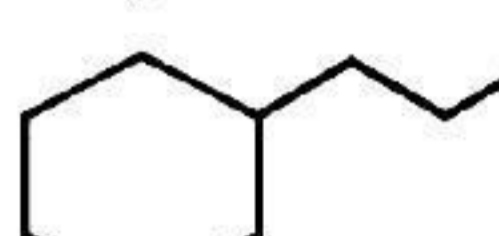
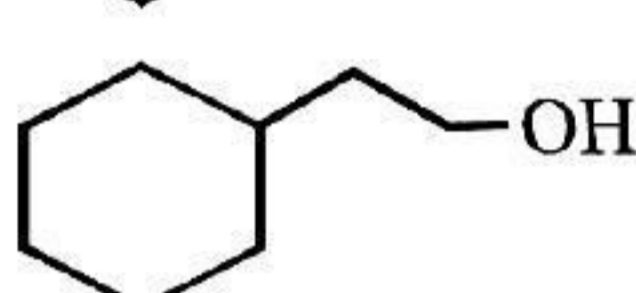
- (a)   
 (b)   
 (c)   
 (d) 

96. The compounds  $[\text{PtCl}_2(\text{NH}_3)_4]\text{Br}_2$  and  $[\text{PtBr}_2(\text{NH}_3)_4]\text{Cl}_2$  constitutes a pair of  
 (a) coordination isomers  
 (b) linkage isomers  
 (c) ionization isomers  
 (d) optical isomers
97. Which of the following factors may be regarded as the main cause of lanthanoid contraction?  
 (a) Greater shielding of  $5d$  electrons by  $4f$  electrons  
 (b) Poorer shielding of  $5d$  electrons by  $4f$  electrons  
 (c) Effective shielding of one of  $4f$  electrons by another in the subshell  
 (d) Poor shielding of one of  $4f$  electron by another in the subshell
98. The polymer used in making synthetic hair wigs is made up of  
 (a)  $\text{CH}_2=\text{CHCl}$   
 (b)  $\text{CH}_2=\text{CHCOOCH}_3$   
 (c)  $\text{C}_6\text{H}_5\text{CH}=\text{CH}_2$   
 (d)  $\text{CH}_2=\text{CH}-\text{CH}=\text{CH}_2$
99. Which of the following is called Wilkinson's catalyst?  
 (a)  $[(\text{Ph}_3\text{P})_3\text{RhCl}]$  (b)  $\text{TiCl}_4 + (\text{C}_2\text{H}_5)_3\text{Al}$   
 (c)  $(\text{C}_2\text{H}_5)_4\text{Pb}$  (d)  $[\text{PtCl}_2(\text{NH}_3)_2]$
100. One mole of an ideal gas is allowed to expand reversibly and adiabatically from a temperature of  $27^\circ\text{C}$ . If the work done during the process is  $3 \text{ kJ}$ , the final temperature will be equal to ( $C_v = 20 \text{ JK}^{-1}$ )  
 (a)  $150 \text{ K}$  (b)  $100 \text{ K}$   
 (c)  $26.85 \text{ K}$  (d)  $295 \text{ K}$

## SECTION-B

### MATHEMATICS

1. In an entrance test, there are multiple choice questions. There are four possible answers to each question, of which one is correct. The probability that a student knows the answer to a question is 90%. If he gets the correct answer to a question, then the probability that he was guessing is  
 (a)  $\frac{1}{40}$     (b)  $\frac{1}{39}$     (c)  $\frac{1}{37}$     (d)  $\frac{2}{43}$
2. If  $\pi/2 < x < \pi$ , then  $\int x \sqrt{\frac{1+\cos 2x}{2}} dx =$   
 (a)  $\cos x + x \sin x + C$     (b)  $-\cos x - x \sin x + C$   
 (c)  $\sin x + x \cos x + C$     (d)  $x \sin x - \cos x + C$
3. A rectangle with one side lying along the  $x$ -axis is to be inscribed in the closed region of the  $xy$  plane bounded by the lines  $y=0$ ,  $y=3x$  and  $y=30-2x$ . The largest area of such a rectangle is  
 (a)  $135/8$     (b)  $45$     (c)  $135/2$     (d)  $90$
4. If  $f: \mathbb{R} \rightarrow \mathbb{R}$  be a function defined by  $f(x) = 4x^3 - 7$ . Then  
 (a)  $f$  is one-one -into    (b)  $f$  is many-one -into  
 (c)  $f$  is many-one onto    (d)  $f$  is bijective
5.  $\sim((\sim p) \wedge q)$  is equal to  
 (a)  $p \vee (\sim q)$     (b)  $p \vee q$   
 (c)  $p \wedge (\sim q)$     (d)  $\sim p \wedge \sim q$
6. With the usual notation  $\int_1^2 ([x^2] - [x]^2) dx$  is equal to  
 (a)  $4 + \sqrt{2} - \sqrt{3}$     (b)  $4 - \sqrt{2} + \sqrt{3}$   
 (c)  $4 - \sqrt{2} - \sqrt{3}$     (d) none of these
7. The general solution of  $x(1+y^2)^{1/2} dx + y(1+x^2)^{1/2} dy = 0$  is  
 (a)  $\cos^{-1} x + \cos^{-1} y = C$   
 (b)  $x^2 + y^2 = (1+x^2)^{1/2} + (1+y^2)^{1/2} + C$   
 (c)  $(1+x^2)^{1/2} + (1+y^2)^{1/2} = C$   
 (d)  $\tan^{-1} x - \tan^{-1} y = C$
8. If  $A = \begin{bmatrix} 0 & 0 & 1 \\ 0 & 1 & 0 \\ 1 & 0 & 0 \end{bmatrix}$ , then  $A^{2008}$  is equal to  
 (a)  $A$     (b)  $A^{-1}$     (c)  $I_3$     (d)  $0$
9. Three vertices of a parallelogram ABCD are  $A(3, -1, 2)$ ,  $B(1, 2, -4)$  and  $C(-1, 1, 2)$ . The coordinates of fourth vertex D are  
 (a)  $(1, 1, 1)$     (b)  $(1, -2, 8)$   
 (c)  $(2, -2, 6)$     (d)  $(1, 0, 2)$
10. The value of  $\int \frac{\sin x + \cos x}{\sqrt{1 - \sin 2x}} dx$  is equal to  
 (a)  $\sqrt{\sin 2x} + c$   
 (b)  $\sqrt{\cos 2x} + c$   
 (c)  $\pm(\sin x - \cos x) + c$   
 (d)  $\pm \log(\sin x - \cos x) + c$
11. The equation of the plane containing the line  $\frac{x+1}{-3} = \frac{y-3}{2} = \frac{z+2}{1}$  and the point  $(0, 7, -7)$ , is  
 (a)  $x + y + z = 2$     (b)  $x + y + z = 3$   
 (c)  $x + y + z = 0$     (d) None of these
12. The co-ordinates of the foot of perpendicular from the point A  $(1, 1, 1)$  on the line joining the points B  $(1, 4, 6)$  and C  $(5, 4, 4)$  are  
 (a)  $(3, 4, 5)$     (b)  $(4, 5, 3)$   
 (c)  $(3, -4, 5)$     (d)  $(-3, -4, 5)$
13.  $(p \wedge \sim q) \wedge (\sim p \wedge q)$  is  
 (a) A tautology  
 (b) A contradiction  
 (c) Both a tautology and a contradiction  
 (d) Neither a tautology nor a contradiction
14. Two finite sets have  $m$  and  $n$  elements. The total number of subsets of the first set is 56 more than the total number of subsets of the second set. Then :  
 (a)  $m=3, n=6$     (b)  $m=6, n=3$   
 (c)  $m=5, n=6$     (d) None of these
15. Let  $f$  be the function defined by  

$$f(x) = \begin{cases} \frac{x^2 - 1}{x^2 - 2|x-1| - 1}, & x \neq 1 \\ 1/2, & x = 1 \end{cases}$$
 (a) The function is continuous for all values of  $x$   
 (b) The function is continuous only for  $x > 1$   
 (c) The function is continuous at  $x = 1$   
 (d) The function is not continuous at  $x = 1$
16. The distance of the point  $(1, -2, 3)$  from the plane  $x - y + z = 5$  measured parallel to the line  $\frac{x}{2} = \frac{y}{3} = \frac{z-1}{-6}$  is  
 (a) 1    (b) 2  
 (c) 4    (d) None of these

17.  $\int \frac{x + \sin x}{1 + \cos x} dx$  is equal to :
- (a)  $x \tan \frac{x}{2} + C$       (b)  $\cot \frac{x}{2} + C$   
(c)  $\log(1 + \cos x) + C$       (d)  $\log(x + \sin x) + C$
18. The maximum value of  $z = 6x + 8y$  subject to constraints  $2x + y \leq 30$ ,  $x + 2y \leq 24$  and  $x \geq 0$ ,  $y \geq 0$  is  
(a) 90      (b) 120      (c) 96      (d) 240
19.  $\int_{\pi/3}^{\pi/2} x \sin(\pi[x] - x) dx$  is equal to :
- (a)  $\frac{1}{2} + \frac{\pi}{6}$       (b)  $1 - \frac{\sqrt{3}}{2} + \frac{\pi}{6}$   
(c)  $-\frac{1}{2} - \frac{\pi}{6}$       (d)  $\frac{\sqrt{3}}{2} - 1 - \frac{\pi}{6}$
20. The general solution of the equation  $\tan \theta + \tan 4\theta + \tan 7\theta = \tan \theta \tan 4\theta \tan 7\theta$   
(a)  $\theta = \frac{n\pi}{4}$       (b)  $\theta = \frac{n\pi}{12}$   
(c)  $\theta = \frac{n\pi}{6}$       (d) None of these
21. For non zero, non collinear vectors  $\vec{p}$  and  $\vec{q}$ , the value of  $[\hat{i} \vec{p} \vec{q}] \hat{i} + [\hat{j} \vec{p} \vec{q}] \hat{j} + [\hat{k} \vec{p} \vec{q}] \hat{k}$  is  
(a)  $\vec{0}$       (b)  $2(\vec{p} \times \vec{q})$   
(c)  $(\vec{q} \times \vec{p})$       (d)  $(\vec{p} \times \vec{q})$
22. Let  $f(\theta) = \sin \theta (\sin \theta + \sin 3\theta)$  then  
(a)  $f(\theta) \geq 0 \forall \theta \in R$       (b)  $f(\theta) \leq 0 \forall \theta \in R$   
(c)  $f(\theta) \geq 1 \forall \theta \in R$       (d)  $f(\theta) \leq 1 \forall \theta \in R$
23. The maximum value of  $z = 5x + 2y$ , subject to the constraints  $x + y \leq 7$ ,  $x + 2y \leq 10$ ,  $x, y \geq 0$  is  
(a) 10      (b) 26      (c) 35      (d) 70
24. The volume of the greatest cylinder which can be inscribed in a cone of height 30 cm and semi-vertical angle  $30^\circ$  is  
(a)  $4000\pi/3 \text{ cm}^3$       (b)  $400\pi/3 \text{ cm}^3$   
(c)  $4000\pi/\sqrt{3} \text{ cm}^3$       (d) None of these
25. The equation of the plane through the line  $x + y + z + 3 = 0 = 2x - y + 3z + 1$  and parallel to the line  $\frac{x}{1} = \frac{y}{2} = \frac{z}{3}$ , is  
(a)  $x - 5y + 3z = 7$       (b)  $x - 5y + 3z = -7$   
(c)  $x + 5y + 3z = 7$       (d)  $x + 5y + 3z = -7$
26. Let  $\vec{a}, \vec{b}$  and  $\vec{c}$  be non-coplanar unit vectors equally inclined to one another at an acute angle  $\theta$ . Then  $[\vec{a} \vec{b} \vec{c}]$  in terms of  $\theta$  is equal to :  
(a)  $(1 + \cos \theta) \sqrt{\cos 2\theta}$   
(b)  $(1 + \cos \theta) \sqrt{1 - 2 \cos 2\theta}$   
(c)  $(1 - \cos \theta) \sqrt{1 + 2 \cos \theta}$   
(d) None of these
27. General solution of the equation  $\sin 2x - \sin 4x + \sin 6x = 0$  is  
(a)  $\frac{n\pi}{4}$  or  $n\pi \pm \frac{\pi}{6}$       (b)  $n\pi$  or  $n\pi \pm \frac{\pi}{3}$   
(c)  $n\pi \pm \frac{\pi}{4}$       (d)  $n\pi$  or  $2n\pi \pm \frac{\pi}{4}$
28. A focus of an ellipse is at the origin. The directrix is the line  $x = 4$  and the eccentricity is  $\frac{1}{2}$ . Then the length of the semi-major axis is  
(a)  $\frac{8}{3}$       (b)  $\frac{2}{3}$       (c)  $\frac{4}{3}$       (d)  $\frac{5}{3}$
29. The locus of a point that is equidistant from the lines  $x + y - 2\sqrt{2} = 0$  and  $x + y - \sqrt{2} = 0$  is  
(a)  $x + y - 5\sqrt{2} = 0$       (b)  $x + y - 3\sqrt{2} = 0$   
(c)  $2x + 2y - 3\sqrt{2} = 0$       (d)  $2x + 2y - 5\sqrt{2} = 0$
30. A ray of light coming from the point (1, 2) is reflected at a point A on the x-axis and then passes through the point (5, 3). The co-ordinates of the point A is  
(a)  $\left(\frac{13}{5}, 0\right)$       (b)  $\left(\frac{5}{13}, 0\right)$   
(c)  $(-7, 0)$       (d) None of these
31. If  $x \in R - \{0\}$ , then  $\tan^{-1} \left( \frac{\sqrt{1+x^2} + \sqrt{1-x^2}}{\sqrt{1+x^2} - \sqrt{1-x^2}} \right)$   
(a)  $\frac{1}{2} \cos^{-1}(x^2)$       (b)  $\frac{\pi}{2} + \frac{1}{2} \cos^{-1}(x^2)$   
(c)  $\frac{\pi}{4} + \frac{1}{2} \cos^{-1}(x^2)$       (d) None of these
32. If  $y = x^{x^2}$ , then  $\frac{dy}{dx}$  is equal to  
(a)  $(2 \ln x)$       (b)  $(2 \ln x + 1)$   
(c)  $(\ln \ln x + 1)x^{x^2}$       (d) None of these

33. In a triangle ABC,  $\angle C = 90^\circ$ , then  $\frac{a^2 - b^2}{a^2 + b^2}$  is equal to :  
 (a)  $\sin(A + B)$  (b)  $\sin(A - B)$   
 (c)  $\cos(A + B)$  (d)  $\sin\left(\frac{A - B}{2}\right)$
34. The internal angles of a convex polygon are in A.P. The smallest angle is  $120^\circ$  and the common difference is  $5^\circ$ . The number of sides of the polygon is  
 (a) 8 (b) 9 (c) 10 (d) 16
35. In a binomial distribution  $n = 5$ ,  $P(X = 1) = 0.4096$  and  $P(X = 2) = 0.2048$ , then the mean of the distribution is equal to  
 (a) 1 (b) 1.5 (c) 2 (d) 2.5
36. The equation of tangent to the curve  $y = \sin^{-1} \frac{2x}{1+x^2}$  at  $x = \sqrt{3}$  is  
 (a)  $y = -\frac{1}{2}(x - \sqrt{3})$   
 (b)  $y - \frac{\pi}{3} = -\frac{1}{2}(x - \sqrt{3})$   
 (c)  $y + \frac{\pi}{3} = -\frac{1}{2}(x - \sqrt{3})$   
 (d) None of these
37. Let A, B be two events such that the probability of A is  $\frac{3}{10}$  and conditional probability of A given B is  $\frac{1}{2}$ . The probability that exactly one of the events A or B happen equals  
 (a)  $\frac{1}{2}$  (b)  $\frac{1}{6}$  (c)  $\frac{3}{10}$  (d)  $\frac{7}{10}$
38. If the line passing through  $P(1, 2)$  making an angle with the  $x$ -axis in the positive direction meets the pair of lines  $x^2 + 4xy + y^2$  at A and B, then  $PA \cdot PB =$   
 (a)  $\frac{13}{3}$  (b)  $\frac{13}{6}$  (c)  $\frac{11}{6}$  (d)  $\frac{11}{3}$
39. If the curves  $ay + x^2 = 7$  and  $x^3 = y$  cut orthogonally at  $(1, 1)$ , then the value of  $a$  is.  
 (a) 5 (b) 6 (c) 7 (d) 8
40. The value of  $\cos\left(2 \cos^{-1} x + \sin^{-1} x\right)$  at  $x = \frac{1}{5}$  is  
 (a)  $-\frac{2\sqrt{6}}{5}$  (b)  $-2\sqrt{6}$  (c)  $-\frac{\sqrt{6}}{5}$  (d) None
41. Which of the following is logically equivalent to  $\sim(\sim p \Rightarrow q)$   
 (a)  $p \wedge q$  (b)  $p \wedge \sim q$   
 (c)  $\sim p \wedge q$  (d)  $\sim p \wedge \sim q$
42. The area of the region bounded by the curves  $y = |x - 2|$ ,  $x = 1$ ,  $x = 3$  and the  $x$ -axis is  
 (a) 4 (b) 2 (c) 3 (d) 1
43. If the slope of the tangent at  $(x, y)$  to a curve passing through  $\left(1, \frac{\pi}{4}\right)$  is given by  $\frac{y}{x} - \cos^2\left(\frac{y}{x}\right)$ , then the equation of the curve is :  
 (a)  $y = \tan^{-1} \log(e/x)$   
 (b)  $y = e^{1 + \cot(y/x)}$   
 (c)  $y = x \tan^{-1} \log(e/x)$   
 (d)  $y = e^{1 + \tan(y/x)}$
44. A fair coin is tossed 99 times. If X is the number of times head occurs,  $P(X = r)$  is maximum when r is  
 (a) 49 or 50 (b) 50 or 51  
 (c) 51 (d) None of these
45. The fourth term of an A.P. is three times of the first term and the seventh term exceeds the twice of the third term by one, then the common difference of the progression is  
 (a) 2 (b) 3 (c)  $\frac{3}{2}$  (d) -1
46. The eccentricity of the hyperbola  $x^2 - 3y^2 = 2x + 8$  is  
 (a)  $\frac{2}{3}$  (b)  $\frac{1}{3}$  (c)  $\frac{2}{\sqrt{3}}$  (d)  $\frac{3}{2}$
47. The differential equation representing the family of curves  $y^2 = 2c(x + \sqrt{c})$ , where  $c$  is a positive parameter, is of  
 (a) order 3 (b) order 2  
 (c) degree 3 (d) degree 4
48. If  $f(x) = \frac{1}{1-x}$ , the number of points of discontinuity of  $f\{f[f(x)]\}$  is :  
 (a) 2 (b) 1 (c) 0 (d) infinite
49. If  $x = a(\cos t + t \sin t)$  and  $y = a(\sin t - t \cos t)$ , then  $\frac{d^2 y}{dx^2}$  is  
 (a)  $\sec^3 t$  (b)  $at \sec^3 t$   
 (c)  $\frac{\sec^3 t}{at}$  (d)  $\sec^2 t$
50. The number of solutions of equation  $x_2 - x_3 = 1$ ,  $-x_1 + 2x_3 = 2$ ,  $x_1 - 2x_2 = 3$  is  
 (a) zero (b) one (c) two (d) infinite

# ANSWER KEYS & SOLUTIONS

## (MHT-CET 2020)



### Answer KEYS

SECTION-A																			
PHYSICS																			
1	(a)	6	(c)	11	(c)	16	(a)	21	(d)	26	(c)	31	(b)	36	(d)	41	(c)	46	(d)
2	(c)	7	(b)	12	(d)	17	(b)	22	(c)	27	(c)	32	(b)	37	(c)	42	(d)	47	(a)
3	(b)	8	(c)	13	(a)	18	(d)	23	(d)	28	(a)	33	(a)	38	(c)	43	(c)	48	(d)
4	(b)	9	(c)	14	(a)	19	(d)	24	(d)	29	(b)	34	(b)	39	(a)	44	(b)	49	(a)
5	(a)	10	(a)	15	(c)	20	(b)	25	(c)	30	(c)	35	(b)	40	(b)	45	(b)	50	(d)
CHEMISTRY																			
51	(a)	56	(d)	61	(c)	66	(a)	71	(c)	76	(b)	81	(d)	86	(c)	91	(a)	96	(c)
52	(a)	57	(b)	62	(b)	67	(b)	72	(d)	77	(c)	82	(b)	87	(a)	92	(c)	97	(b)
53	(b)	58	(d)	63	(c)	68	(b)	73	(a)	78	(b)	83	(b)	88	(c)	93	(b)	98	(a)
54	(a)	59	(b)	64	(a)	69	(c)	74	(d)	79	(c)	84	(d)	89	(d)	94	(a)	99	(a)
55	(d)	60	(a)	65	(b)	70	(a)	75	(a)	80	(b)	85	(d)	90	(d)	95	(b)	100	(a)
SECTION-B																			
MATHEMATICS																			
1	(c)	6	(c)	11	(c)	16	(a)	21	(d)	26	(c)	31	(c)	36	(b)	41	(d)	46	(c)
2	(b)	7	(c)	12	(a)	17	(a)	22	(a)	27	(a)	32	(d)	37	(c)	42	(d)	47	(c)
3	(c)	8	(c)	13	(b)	18	(b)	23	(c)	28	(a)	33	(b)	38	(a)	43	(c)	48	(a)
4	(d)	9	(b)	14	(b)	19	(b)	24	(a)	29	(c)	34	(b)	39	(b)	44	(a)	49	(c)
5	(a)	10	(d)	15	(d)	20	(b)	25	(a)	30	(a)	35	(a)	40	(a)	45	(a)	50	(a)

### SECTION-A

#### PHYSICS

1. (a)  $\delta = \frac{W\ell^3}{3YI}$ , where  $W$  = load,  $\ell$  = length of

beam and  $I$  is geometrical moment of inertia for rectangular beam,

$$I = \frac{bd^3}{12} \text{ where } b = \text{breadth and } d = \text{depth}$$

For square beam  $b = d$   $\therefore I_1 = \frac{b^4}{12}$

For a beam of circular cross-section,  $I_2 = \left(\frac{\pi r^4}{4}\right)$

$$\therefore \delta_1 = \frac{W\ell^3 \times 12}{3Yb^4} = \frac{4W\ell^3}{Yb^4}$$

(for sq. cross-section)

$$\text{and } \delta_2 = \frac{W\ell^3}{3Y(\pi r^4/4)} = \frac{4W\ell^3}{3Y(\pi r^4)}$$

(for circular cross-section)

$$\text{Now } \frac{\delta_1}{\delta_2} = \frac{3\pi r^4}{b^4} = \frac{3\pi r^4}{(\pi r^2)^2} = \frac{3}{\pi}$$

( $\because b^2 = \pi r^2$  i.e., they have same cross-sectional area)

2. (c)

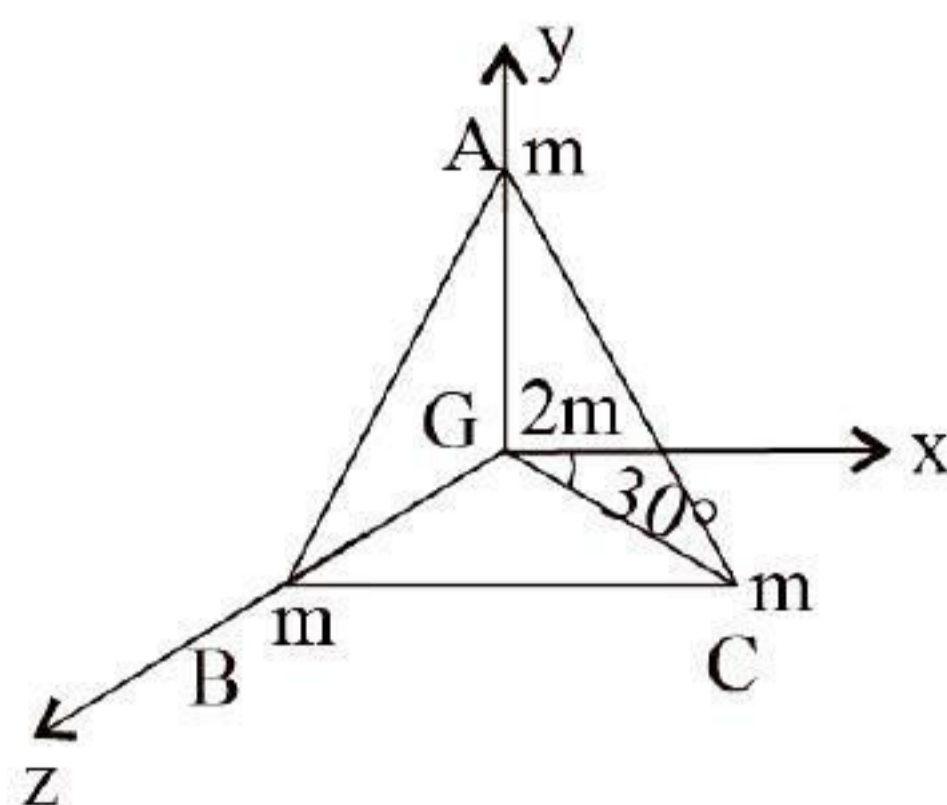

$$F_{GA} = \frac{Gm(2m)}{1} \hat{j}$$

$$F_{GB} = \frac{Gm(2m)}{1} (-\hat{i} \cos 30^\circ - \hat{j} \sin 30^\circ)$$

$$F_{GC} = \frac{Gm(2m)}{1} (\hat{i} \cos 30^\circ - \hat{j} \sin 30^\circ)$$

$$\begin{aligned} \therefore \text{Resultant force on } (2m) \text{ is } F_R \\ = F_{GA} + F_{GB} + F_{GC} \\ = 2Gm^2 \hat{j} + 2Gm^2 \hat{i} (-\cos 30^\circ + \cos 30^\circ) \\ \quad + 2Gm^2 \hat{j} (-\sin 30^\circ - \sin 30^\circ) \\ = 2Gm^2 \hat{j} - 2Gm^2 \hat{j} \left( -\cancel{\cos 30^\circ} + \cancel{\cos 30^\circ} \right) \\ \quad + 2Gm^2 \hat{j} (-\sin 30^\circ - \sin 30^\circ) \\ = 2Gm^2 \hat{j} - 2Gm^2 \hat{j} \left( -\cancel{\cos 30^\circ} + \cancel{\cos 30^\circ} \right) \\ = 2Gm^2 \hat{j} - 2Gm^2 \hat{j} = 0. \end{aligned}$$

3. (b) Reverse resistance

$$= \frac{\Delta V}{\Delta I} = \frac{1}{0.5 \times 10^{-6}} = 2 \times 10^6 \Omega$$

4. (b)  $v_1 = \frac{dy_1}{dt} = 0.1 \times 100\pi \cos\left(100\pi t + \frac{\pi}{3}\right)$

$$v_2 = \frac{dy_2}{dt} = -0.1\pi \sin \pi t = 0.1\pi \cos\left(\pi t + \frac{\pi}{2}\right)$$

$$\therefore \text{Phase diff.} = \phi_1 - \phi_2 = \frac{\pi}{3} - \frac{\pi}{2} = \frac{2\pi - 3\pi}{6} = -\frac{\pi}{6}$$

5. (a)  $L_0 = 60 \text{ cm}$        $v_0 = 256 \text{ Hz.}$

$$v = \frac{1}{2L} \sqrt{\frac{T}{m}} \quad \therefore v \propto \frac{1}{L}$$

$$\frac{v_1}{v_0} = \frac{L_0}{L_1} \Rightarrow v_1 = v_0 \frac{L_0}{L_1} = 256 \times \frac{60}{15} = 1024 \text{ Hz.}$$

6. (c)  $m \times 10 = 2 \times 3 \times 10^{-2} \times \frac{10}{100}$

$$\text{or } m = 6 \times 10^{-4} \text{ kg} = 6 \times 10^{-4} \times 10^3 \text{ g} = 0.6 \text{ g}$$

7. (b) Let the mass per unit area be  $\sigma$ . Then the mass of the complete disc

$$= \sigma[\pi(2R)^2] = 4\pi\sigma R^2$$

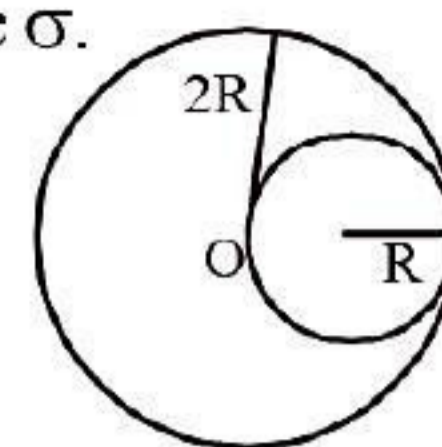

The mass of the removed disc  $= \sigma(\pi R^2) = \pi\sigma R^2$

Let us consider the above situation to be a complete disc of radius  $2R$  on which a disc of radius  $R$  of negative mass is superimposed. Let  $O$  be the origin. Then the above figure can be redrawn keeping in mind the concept of centre of mass as :

$$4\pi\sigma R^2 \xleftarrow{R}$$

$$\bullet \quad \bullet$$

$$O \quad \pi\sigma R^2$$

$$X_{c.m} = \frac{(4\pi\sigma R^2) \times 0 + (-\pi\sigma R^2) R}{4\pi\sigma R^2 - \pi\sigma R^2}$$

$$\therefore x_{c.m} = \frac{-\pi\sigma R^2 \times R}{3\pi\sigma R^2}$$

$$\therefore x_{c.m} = -\frac{R}{3} \Rightarrow \alpha = \frac{1}{3}$$

8. (c)  $I = \frac{2\varepsilon}{R + R_1 + R_2}$

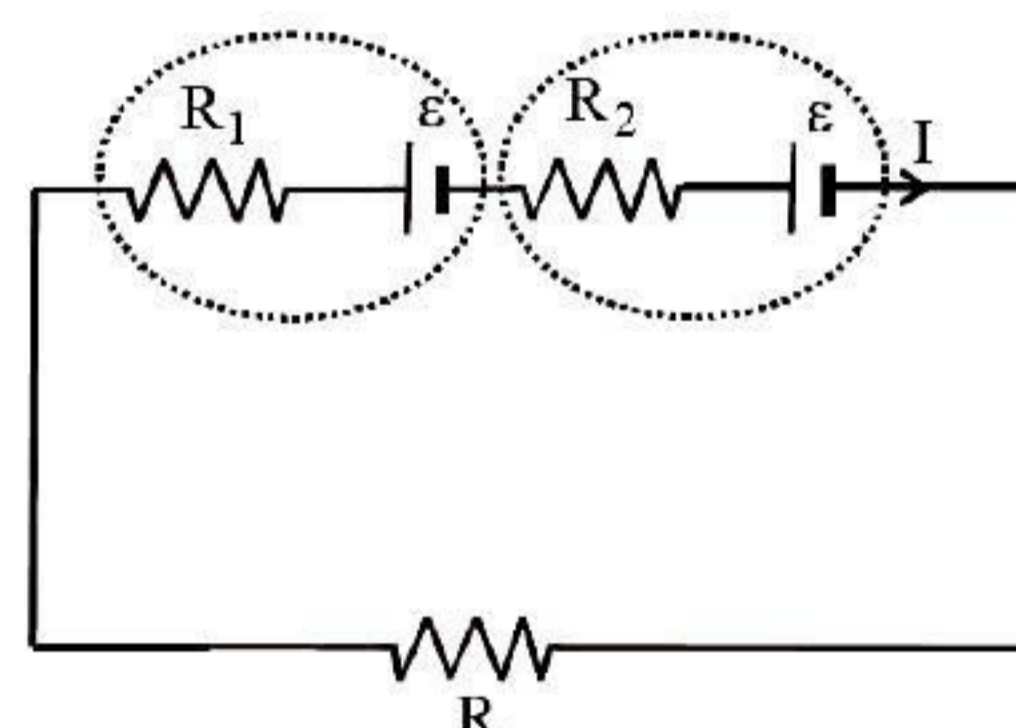

Pot. difference across second cell

$$= V = \varepsilon - IR_2 = 0$$

$$\varepsilon = \frac{2\varepsilon}{R + R_1 + R_2} \cdot R_2 = 0$$

$$R + R_1 + R_2 - 2R_2 = 0$$

$$R + R_1 - R_2 = 0 \quad \therefore R = R_2 - R_1$$

9. (c)

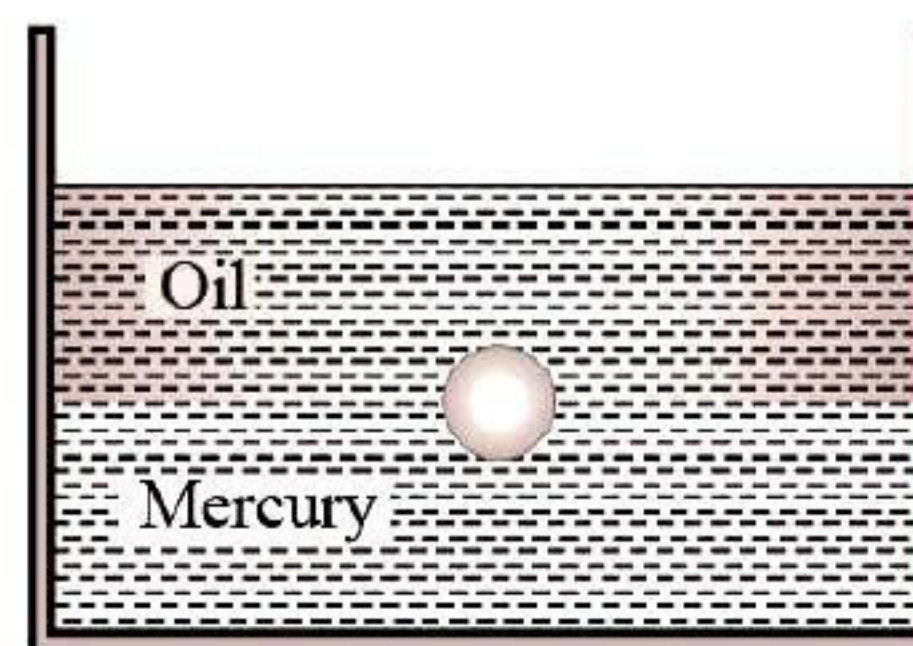

As the sphere floats in the liquid. Therefore its weight will be equal to the upthrust force on it

$$\text{Weight of sphere} = \frac{4}{3}\pi R^3 \rho g \quad \dots (i)$$

$$\begin{aligned} \text{Upthrust due to oil and mercury} \\ = \frac{2}{3}\pi R^3 \times \sigma_{\text{oil}}g + \frac{2}{3}\pi R^3 \sigma_{\text{Hg}}g \quad \dots (ii) \end{aligned}$$

Equating (i) and (ii)

$$\frac{4}{3}\pi R^3 \rho g = \frac{2}{3}\pi R^3 0.8g + \frac{2}{3}\pi R^3 + 13.6g$$

$$\Rightarrow 2\rho = 0.8 + 13.6 = 14.4 \Rightarrow \rho = 7.2$$

$$10. (a) \quad B = \frac{\mu_0 I}{2r} \times \frac{\theta}{2\pi} = \frac{\mu_0 I \theta}{4\pi r}$$

$$11. (c) \quad P_c = \frac{P_t}{1 + \frac{m_a^2}{2}} = \frac{12}{1 + \frac{(0.5)^2}{2}} = \frac{12}{1.25} = 9.6 \text{ kW}$$

$$12. (d) \quad v' = v \left( \frac{v + v_D}{v - v_S} \right)$$

$$\text{Here, } v = 600 \text{ Hz, } v_D = 15 \text{ m/s} \\ v_S = 20 \text{ m/s, } v = 340 \text{ m/s}$$

$$\therefore v' = 600 \left( \frac{355}{320} \right) \approx 666 \text{ Hz}$$

13. (a) Potential at the given point = Potential at the point due to the shell + Potential due to the particle

$$= -\frac{GM}{a} - \frac{2GM}{a} = -\frac{3GM}{a}$$

14. (a) In  $x = A \cos \omega t$ , the particle starts oscillating from extreme position. So at  $t = 0$ , its potential energy is maximum.

15. (c) The electron moves with constant velocity without deflection. Hence, force due to magnetic field is equal and opposite to force due to electric field.

$$qvB = qE \Rightarrow v = \frac{E}{B} = \frac{20}{0.5} = 40 \text{ m/s}$$

$$16. (a) \quad T = 2\pi \sqrt{\left( \frac{I}{MB_H} \right)}$$

$$T' = 2\pi \sqrt{\left( \frac{I}{4MB_H} \right)} = \frac{1}{2} \left[ 2\pi \sqrt{\left( \frac{I}{MB_H} \right)} \right]$$

$$= \frac{1}{2} \times 2 = 1 \text{ second.}$$

17. (b) Current in the circuit,

$$I = \frac{\varepsilon}{R+r}$$

Potential difference across  $R$ ,

$$V = IR = \left( \frac{\varepsilon}{R+r} \right) R = \frac{\varepsilon}{1 + \frac{r}{R}}$$

When  $R = 0$ ,  $V = 0$

$$R = \infty, V = \varepsilon$$

18. (d)  $\lambda_{\text{IR}} > \lambda_{\text{UV}}$  also wavelength of emitted radiation  $\lambda \propto \frac{1}{\Delta E}$ .

19. (d) For stress to be equal,  $\frac{T_1}{A_1} = \frac{T_2}{A_2}$

$$\therefore \frac{T_1}{T_2} = \frac{A_1}{A_2} = \frac{1}{2}$$

20. (b)  $|\vec{A} + \vec{B}| = \sqrt{A^2 + B^2 + 2AB \cos 120^\circ}$   
( $\theta = 120^\circ$ )

$$= \sqrt{A^2 + B^2 + 2AB \left( \frac{-1}{2} \right)} \left( \cos 120^\circ = -\frac{1}{2} \right)$$

$$= \sqrt{A^2 + B^2 - A(A)} = \sqrt{B^2} = B \quad (\because A=B)$$

21. (d) It is a one of Fraunhofer diffraction from single slit. so for bright fringe where  $a$  is the width of slit.

$$a \sin \theta = (2n+1) \frac{\lambda}{2}$$

$$\lambda = \frac{2a \sin \theta}{2n+1} = \frac{2 \times 1.2 \times 10^{-5} \times 0.0906}{2 \times 1 + 1} = 7248 \text{ \AA}$$

22. (c)  $\mu = \frac{F}{R} = \frac{mg \sin \alpha}{mg \cos \alpha} = \tan \alpha$

23. (d)  $\frac{H_1}{H_2} = \frac{u^2 \sin^2 \theta / 2g}{u^2 \sin^2 (90^\circ - \theta) / 2g} = \tan^2 \theta$

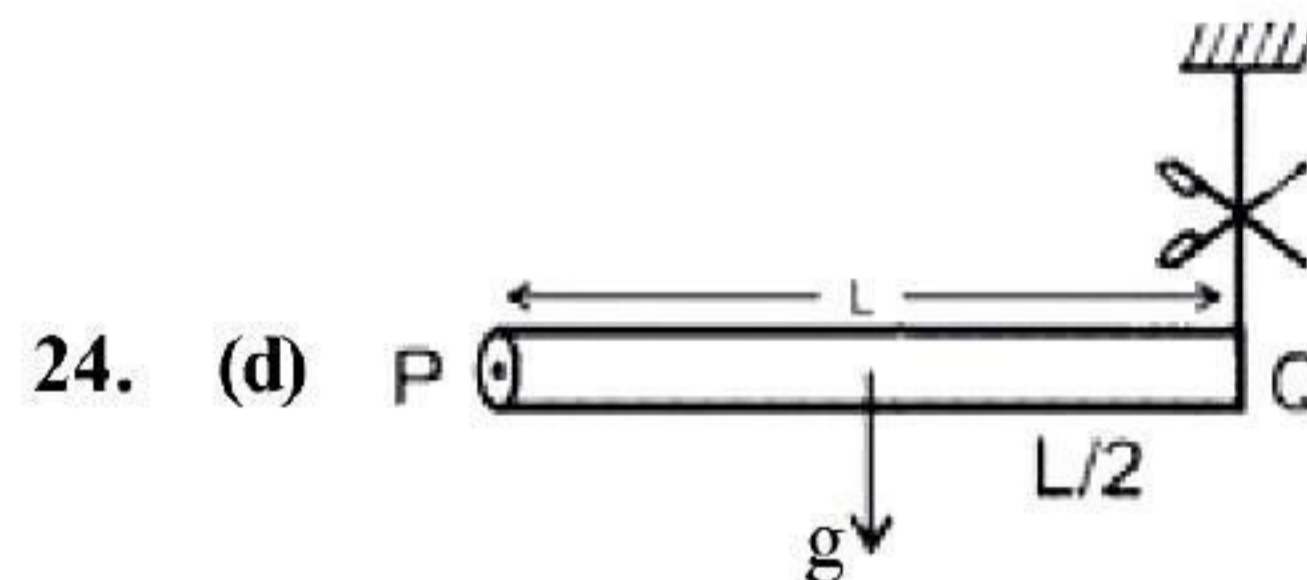

24. (d) angular acceleration  $\alpha = \frac{3g}{2L}$

25. (c) We know that  $\frac{Q^2}{2C}$  is energy of capacitor, so it represent the dimension of energy  $= [ML^2T^{-2}]$ .

26. (c) Power gain = voltage gain  $\times$  current gain

$$-V_G \cdot I_G = \frac{V_0}{V_i} \cdot \frac{I_0}{I_i}$$

$$= \frac{V_0^2}{V_i^2} \cdot \frac{R_i}{R_0} = 50 \times 50 \times \frac{100}{200} = 1250$$

27. (c) Due to volume expansion of both mercury and flask, the change in volume of mercury relative to flask is given by

$$\Delta V = V_0 [\gamma_L - \gamma_g] \Delta \theta = V [\gamma_L - 3\alpha_g] \Delta \theta$$

$$= 50 [180 \times 10^{-6} - 3 \times 9 \times 10^{-6}] (38 - 18)$$

$$= 0.153 \text{ cc}$$

28. (a) With the increase in temperature, the surface tension of liquid decreases and angle of contact also decreases.

29. (b)  $i = \frac{A + \delta_m}{2} = \frac{60 + 30}{2} = 45^\circ$

30. (c)  $\frac{(v_e)_p}{(v_e)_e} = \frac{\sqrt{\frac{2GM_p}{R_p}}}{\sqrt{\frac{2GM_e}{R_e}}} = \sqrt{\frac{M_p}{M_e} \times \frac{R_e}{R_p}}$

$$= \sqrt{\frac{10M_e}{M_e} \times \frac{R_e}{R_e/10}} = 10$$

$$\therefore (v_e)_p = 10 \times (v_e)_e = 10 \times 11 = 110 \text{ km/s}$$

31. (b) Fringe width  $\beta = \frac{\lambda D}{d}$

32. (b) According to Einstein's photoelectric effect, the K.E. of the radiated electrons

$$\text{K.E.}_{\text{max}} = E - W$$

$$\frac{1}{2} m v_1^2 = (1 - 0.5) \text{ eV} = 0.5 \text{ eV}$$

$$\frac{1}{2} m v_2^2 = (2.5 - 0.5) \text{ eV} = 2 \text{ eV}$$

$$\frac{v_1}{v_2} = \sqrt{\frac{0.5}{2}} = \frac{1}{\sqrt{4}} = \frac{1}{2}$$

33. (a)  $\frac{E_0}{B_0} = c$ , also  $k = \frac{2\pi}{\lambda}$  and  $\omega = 2\pi\nu$

These relation gives  $E_0 k - B_0 \omega$

34. (b) Here,  $R_g = 100 \Omega$ ;  $I_g = 10^{-5} \text{ A}$ ;  $I = 1 \text{ A}$ ;  $S = ?$

$$S = \frac{I_g R_g}{I - I_g} = \frac{10^{-5} \times 100}{1 - 10^{-5}} = 10^{-3} \Omega \text{ in parallel}$$

35. (b) Terminal velocity,  $v_0 = \frac{2 r^2 (\rho - \rho_0) g}{9 \eta}$

$$= \frac{2 \times (2 \times 10^{-3})^2 \times (8 - 1.3) \times 10^3 \times 9.8}{9 \times 0.83}$$

$$= 0.07 \text{ ms}^{-1}$$

36. (d)  $T_2 = 7^\circ \text{C} = (7 + 273) = 280 \text{ K}$

$$\eta = 1 - \frac{T_2}{T_1} \Rightarrow \frac{T_2}{T_1} = 1 - \eta$$

$$= 1 - \frac{50}{100} = \frac{50}{100} = \frac{1}{2}$$

$$\therefore T_1 = 2 \times T_2 = 2 \times 280 = 560 \text{ K}$$

New efficiency,  $\eta' = 70\%$

$$\therefore \frac{T_2}{T_1} = 1 - \eta' = 1 - \frac{70}{100} = \frac{30}{100} = \frac{3}{10}$$

$$\therefore T_1' = \frac{10}{3} \times 280 = \frac{2800}{3} = 933.3 \text{ K}$$

$\therefore$  Increase in the temperature of high temp. reservoir =  $933.3 - 560 = 373.3 \text{ K} = 380 \text{ K}$

37. (c) As  $m$  would slip in vertically downward direction, then

$$mg = \mu N$$

$$\Rightarrow N = \frac{mg}{\mu} = \frac{100}{0.5} = 200 \text{ Newton}$$

Same normal force would accelerated  $M$ ,

$$\text{thus } a_M = \frac{200}{50} = 4 \text{ m/s}^2$$

Taking  $m + M$  as system

$$F = (m + M) a = 240 \text{ N}$$

38. (c)  $\frac{\Delta P}{P} \times 100 = \frac{\Delta F}{F} \times 100 + 2 \frac{\Delta \ell}{\ell} \times 100$

$$= 6\% + 2 \times 3\%$$

39. (a) Here,  $u = 0$ ;  $a = \frac{eE}{m}$ ;  $v = ?$ ;  $t = t$

$$\therefore v = u + at = 0 + \frac{eE}{m} t$$

de-Broglie wavelength,

$$\lambda = \frac{h}{mv} = \frac{h}{m(eEt/m)} = \frac{h}{eEt}$$

Rate of change of de-Broglie wavelength

$$\frac{d\lambda}{dt} = \frac{h}{eE} \left( -\frac{1}{t^2} \right) = \frac{-h}{eEt^2}$$

40. (b)  $R_1 = 60 \text{ cm}$ ,  $R_2 = \infty$ ,  $\mu = 1.6$

$$\frac{1}{f} = (\mu - 1) \left( \frac{1}{R_1} - \frac{1}{R_2} \right)$$

$$\frac{1}{f} = (1.6 - 1) \left( \frac{1}{60} \right) \Rightarrow f = 100 \text{ cm.}$$

41. (c) The tension  $T_1$  at the topmost point is given by

$$T_1 = \frac{m v_1^2}{20} - mg$$



Centrifugal force acting outward while weight acting downward.

The tension  $T_2$  at the lowest point

$$T_2 = \frac{mv_2^2}{20} + mg$$

Centrifugal force and weight (both) acting downward

$$T_2 - T_1 = \frac{mv_2^2 - mv_1^2}{20} + 2mg$$

$$v_1^2 = v_2^2 - 2gh \text{ or } v_2^2 - v_1^2 = 2g(40) = 80g$$

$$\therefore T_2 - T_1 = \frac{80mg}{20} + 2mg = 6mg$$

42. (d) Mutual inductance between two coil in the same plane with their centers coinciding is given by

$$M = \frac{\mu_0}{4\pi} \left( \frac{2\pi^2 R_2^2 N_1 N_2}{R_1} \right) \text{ henry.}$$

43. (c)  $[x] = [bt^2]$ . Hence  $[b] = [x/t^2] = \text{km/s}^2$

44. (b)  $3 \times \frac{v}{4l_c} = 4 \times \frac{v}{2l_0}$  or  $\frac{l_c}{l_0} = \frac{3v}{4} \times \frac{2}{4v} = \frac{3}{8}$

45. (b)  $\frac{n_1 + n_2}{\gamma - 1} = \frac{n_1}{\gamma_1 - 1} + \frac{n_2}{\gamma_2 - 1}$

$$\text{or } \frac{2}{\gamma - 1} = \frac{1}{\frac{5}{3} - 1} + \frac{1}{\frac{7}{5} - 1}$$

$$\therefore \gamma = \frac{3}{2}$$

46. (d) At resonance  $\omega L = 1/\omega C$   
and  $i = E/R$ , So power dissipated in circuit is  $P = i^2 R$ .

47. (a) Suppose the liquid in left side limb is displaced slightly by  $y$ , the liquid in right limb will increase by  $y/2$ .

The restoring force

$$F = -PA$$

$$= -\rho g \left( \frac{3y}{2} \right) \times 2A = 3\rho g A(-y).$$

$$a = \frac{F}{m} = 3\rho g A(-y)/m$$

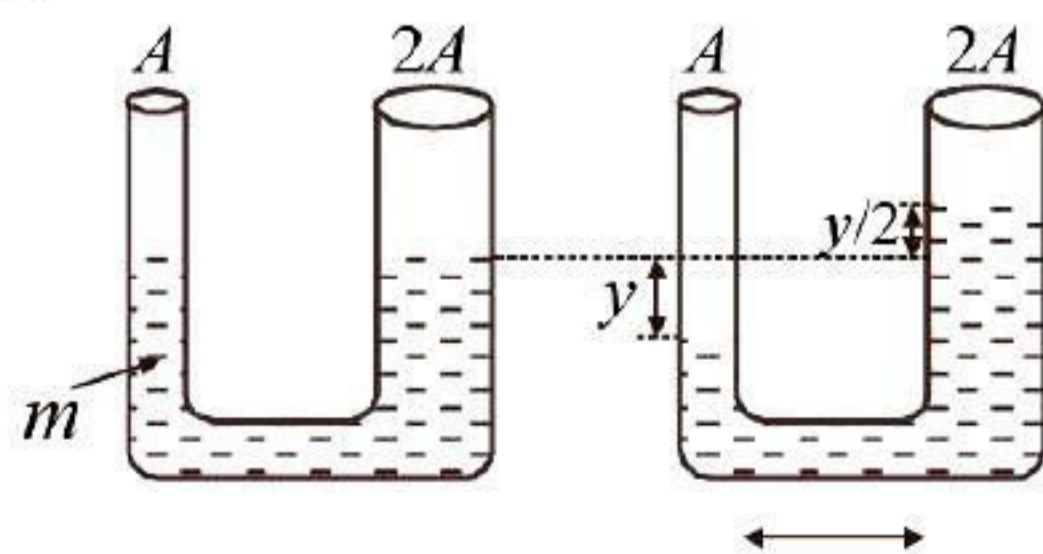

On comparing with,  $a = -\omega^2 y$ , we get

$$\omega = \sqrt{\frac{3\rho g A}{m}} \text{ and } T = 2\pi \sqrt{\frac{m}{3\rho g A}}$$

48. (d) Let 'n' such capacitors are in series and such 'm' such branch are in parallel.

$$\therefore 250 \times n = 1000 \quad \therefore n = 4 \quad \dots \text{(i)}$$

$$\text{Also } \frac{8}{n} \times m = 16 \Rightarrow m = \frac{16 \times n}{8} = 8 \quad \dots \text{(ii)}$$

$$\therefore \text{No. of capacitor} = 8 \times 4 = 32$$

49. (a) Distance of closest approach

$$r_0 = \frac{Ze(2e)}{4\pi\epsilon_0 \left( \frac{1}{2}mv^2 \right)}$$

$$\text{Energy, } E = 5 \times 10^6 \times 1.6 \times 10^{-19} \text{ J}$$

$$\therefore r_0 = \frac{9 \times 10^9 \times (92 \times 1.6 \times 10^{-19}) (2 \times 1.6 \times 10^{-19})}{5 \times 10^6 \times 1.6 \times 10^{-19}}$$

$$\Rightarrow r = 5.2 \times 10^{-14} \text{ m} = 5.3 \times 10^{-12} \text{ cm.}$$

50. (d)  $\tau = MB \sin \theta \Rightarrow \tau_{\max} = NiAB$ ,  $[\theta = 90^\circ]$

## CHEMISTRY

51. (a)  $4\text{KO}_2 + 2\text{CO}_2 \rightarrow 2\text{K}_2\text{CO}_3 + 3\text{O}_2$ .

$\text{KO}_2$  is used as an oxidising agent. It is used as air purifier in space capsules. Submarines and breathing masks as it **produces oxygen and remove carbon dioxide**.

52. (a) Bactericidal are the drugs that kills bacteria. Ofloxacin works by stopping the growth of bacteria. This antibiotic treats only bacterial infections.

53. (b)  $\Delta U = q + w$   
 $= 10 \times 1000 - 2 \times (20) \times 101.3 = 5948 \text{ J}$

54. (a)  $m = \frac{E \times i \times t}{96500}$ ;  $2 = \frac{31.75 \times 5 \times t}{96500}$ ,

$$\therefore t = 12157.48 \text{ sec.}$$

55. (d) Aldol condensation is given by only those aldehydes or ketones which have  $\alpha$ -hydrogen atom on a saturated carbon;  $\alpha$ -H present on unsaturated carbon atom cannot be easily removed by a base.

56. (d) For a fcc unit cell

$$r = \frac{\sqrt{2}a}{4}$$

$$a = \frac{4r}{\sqrt{2}} = 2\sqrt{2} \times 0.14 = 0.39 \approx 0.4 \text{ nm.}$$

57. (b)  $PV = RT$ ,  $PV = \frac{w}{M} RT$ ,

$$20P = \frac{120}{40} \times 0.0821 \times 400$$

$$\text{or } P = 4.92 \text{ atm}$$

58. (d)

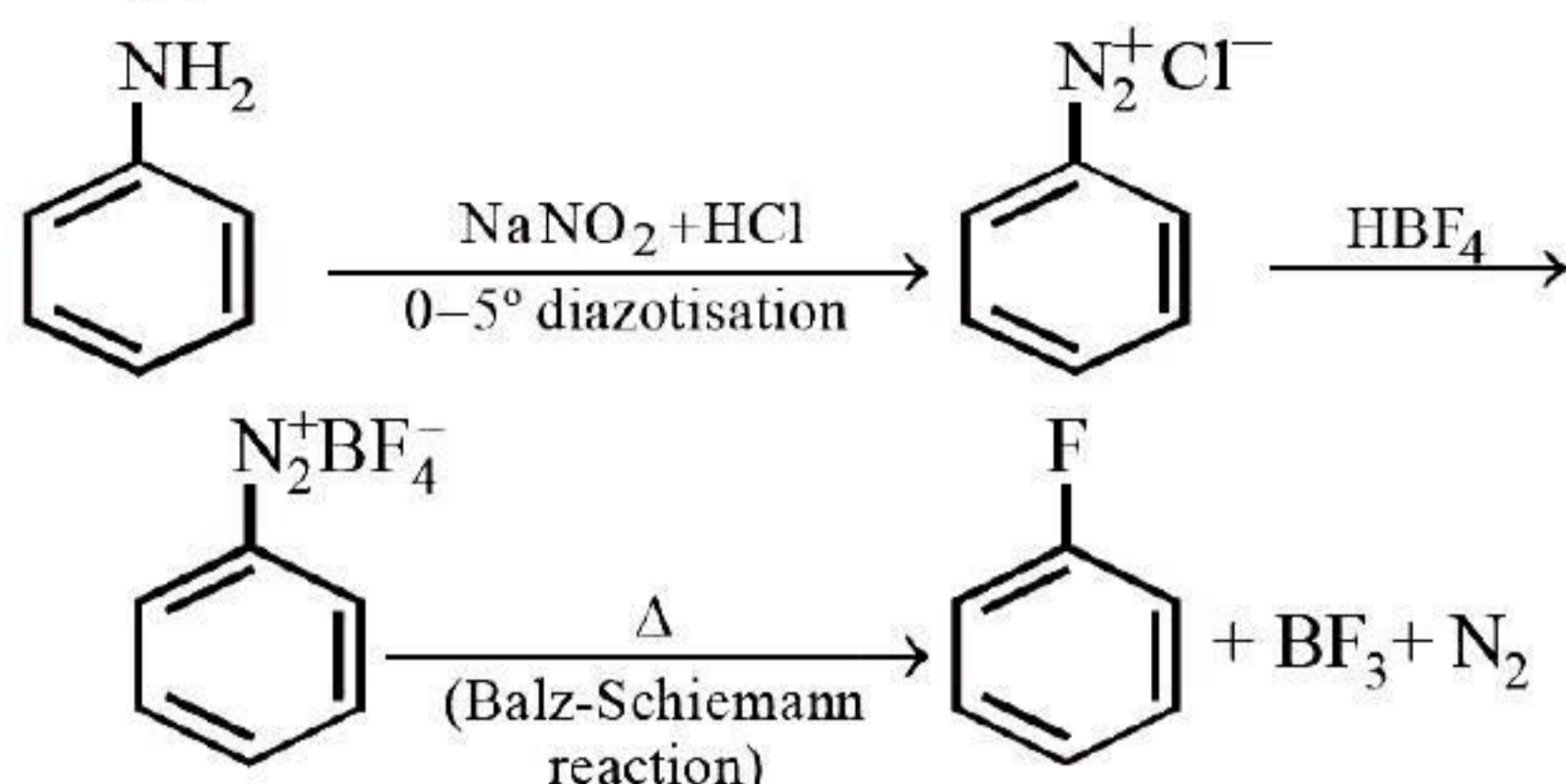

59. (b) Benzoic acid is used as preservative as sodium benzoate.

60. (a) Only 1° aromatic amines undergo coupling reactions to form a dye.

61. (c)  $H_2^+ : \sigma 1s^1 \quad \therefore \text{B.O.} = \frac{1}{2}(1-0) = \frac{1}{2}$

$H_2^- : \sigma 1s^2 \sigma^* 1s^1 \quad \therefore \text{B.O.} = \frac{1}{2}(2-1) = \frac{1}{2}$

Even though the bond order of  $H_2^+$  and  $H_2^-$  are equal but  $H_2^+$  is more stable than  $H_2^-$  as in the latter, one electron is present in the antibonding ( $\sigma^* 1s$ ) orbital of higher energy.

62. (b) Moles of glucose =  $\frac{18}{180} = 0.1$

Moles of water =  $\frac{178.2}{18} = 9.9$

Total moles =  $0.1 + 9.9 = 10$

$P_{H_2O} = \text{Mole fraction} \times \text{total pressure}$

$$= \frac{9.9}{10} \times 760 = 752.4 \text{ Torr}$$

63. (c)  $CO_2$ ,  $SiO_2$  are acidic,  $CaO$  is basic and  $SnO_2$  is amphoteric.

64. (a) Since concentration of ions is the same hence  $E_{\text{cell}} = E_{\text{cell}}^\circ$

65. (b) Benzaldehyde forms cinnamic acid as follows.

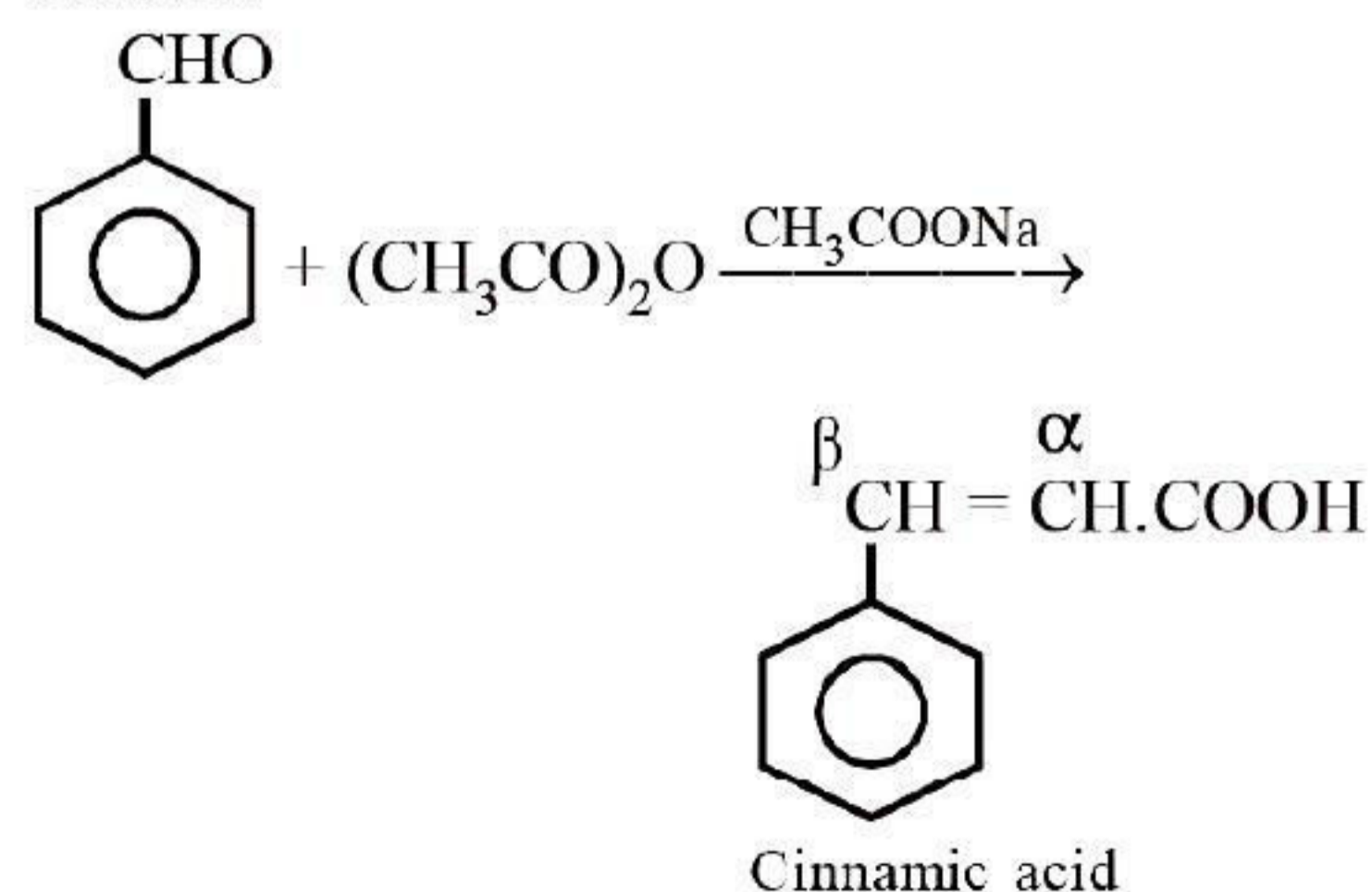

66. (a)  $[Fe(H_2O)_5NO]SO_4$

Let O.N. of Fe be  $x$  then,

$$1 \times (x) + 5 \times (0) + 1 \times (+1) + 1 \times (-2) = 0$$

$$\therefore x = +1$$

67. (b)

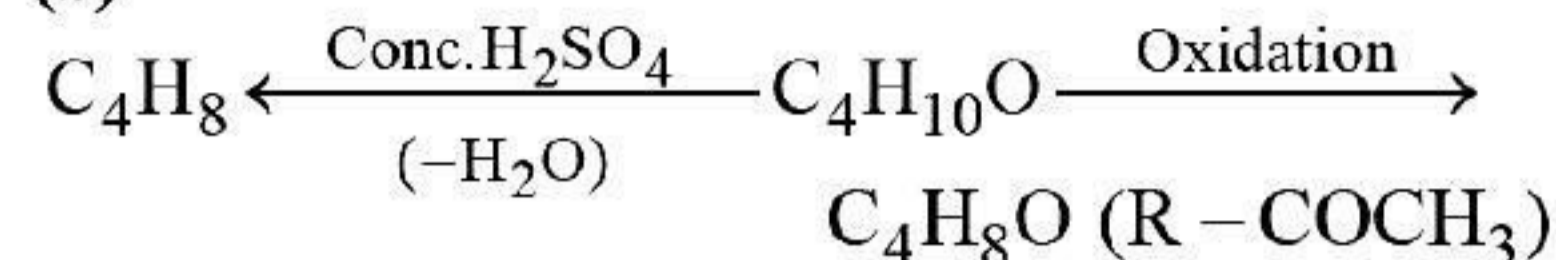

Thus  $C_4H_8O$  should be  $CH_3CH_2COCH_3$ , hence  $C_4H_{10}O$  should be  $CH_3CH_2CHOHCH_3$

68. (b) The required equation is

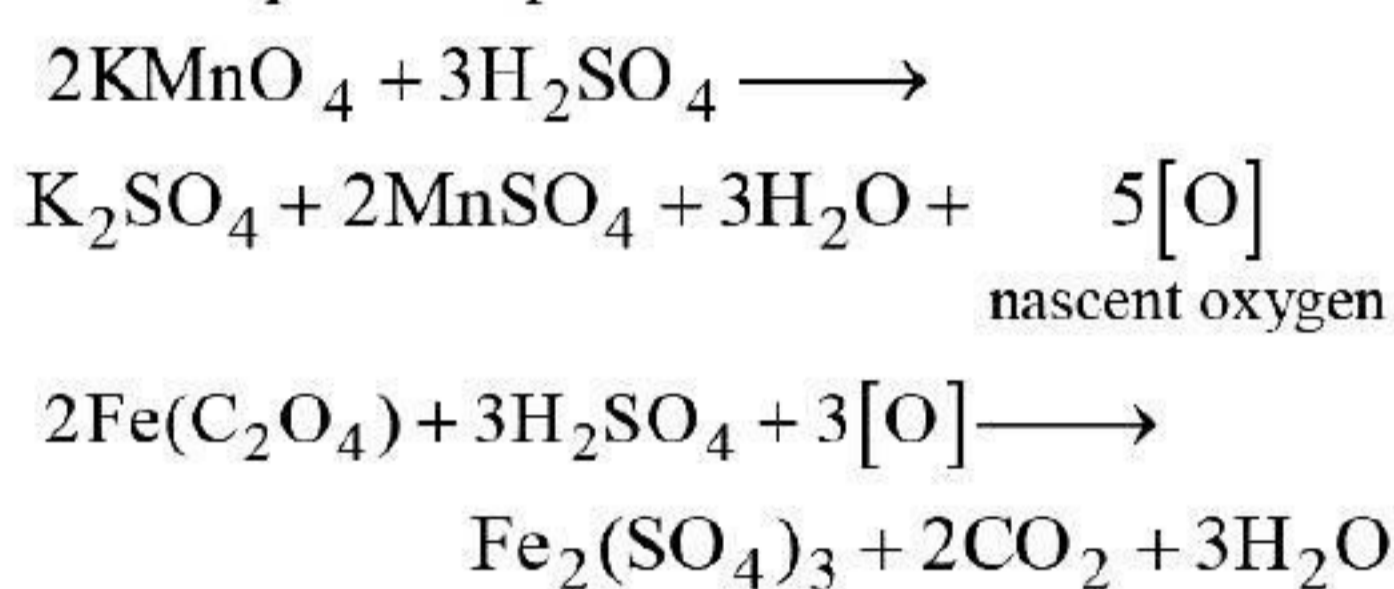

O required for 1 mol. of  $Fe(C_2O_4)$  is 1.5, 5O are obtained from 2 moles of  $KMnO_4$

$\therefore 1.5 [O]$  will be obtained from  $= \frac{2}{5} \times 1.5 = 0.6$  moles of  $KMnO_4$ .

69. (c) This reaction occurs according to Markownikoff's rule which states that when an unsymmetrical alkene undergo hydrohalogenation, the negative part goes to that C-atom which contain lesser no. of H-atom.

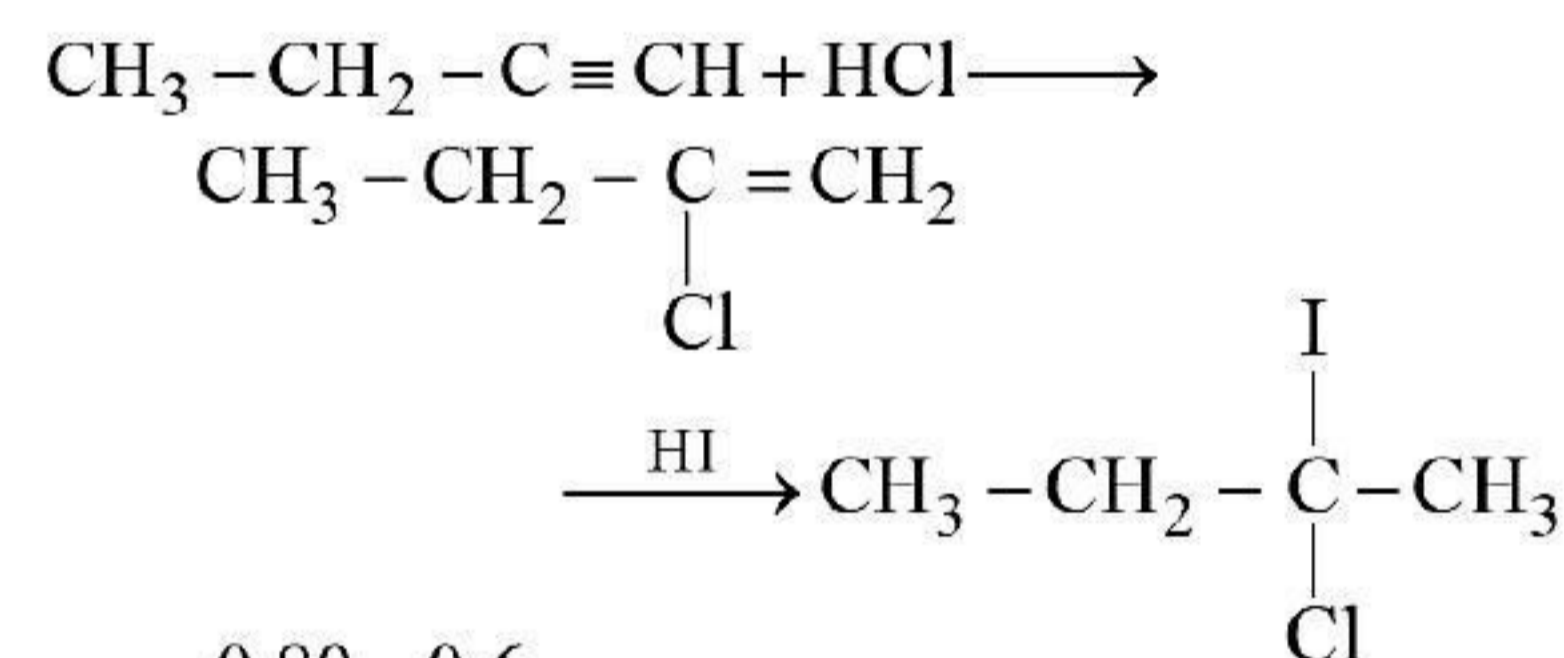

70. (a)  $\frac{0.80-0.6}{0.80} = x_B; x_B = 0.25$

71. (c)  $MgO$  being high melting does not catch fire and hence protects the cooker against fire.

72. (d)  $K_2Cr_2O_7 + \text{conc. } HCl \rightarrow Cl_2$

73. (a) Maximum lowering of vapour pressure will be given by the substance which give maximum number of particles in solution.

74. (d) Positive charge  $\uparrow$ ; coagulating power  $\uparrow$  so,  $MgCl_2$  will be most effective.

75. (a) No compound of Ar has yet been reported with  $F_2$ .

76. (b) Oxygen being more electronegative, will be best oxidising agent among given options.

77. (c)  $t_{1/2}$  is independent of initial concentration.  $\therefore t_{1/2} \propto a^0$ .

78. (b)  $\Delta G = \Delta H - T\Delta S$   
 $= -382.64 + (298 \times 145.6 \times 10^{-3})$   
 $= -339.3 \text{ kJ mol}^{-1}$
79. (c) Polythene is a linear polymer.
80. (b) Since silica is acidic impurity the flux must be basic.

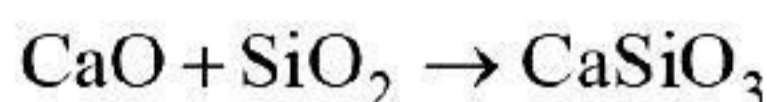

81. (d)  $A \rightarrow B, \Delta H = -10 \text{ kJ mol}^{-1}$   
 It is an exothermic reaction,

$$E_{a(b)} = E_{a(f)} - (\Delta H)$$

$$= 50 - (-10) = 60 \text{ kJ}$$

82. (b)  $\text{Cl}^-$  is oxidised to  $\text{Cl}_2$  at anode.

83. (b) Density = 1.17 g/cc (Given)

$$\text{As } d = \frac{\text{Mass}}{\text{Volume}}$$

$$\text{Volume} = 1 \text{ cc} \quad \therefore \text{Mass} = d = 1.17 \text{ g}$$

$$\text{Molarity} = \frac{\text{No. of moles}}{\text{Volume in litre}} = \frac{1.17 \times 1000}{36.5 \times 1}$$

$$= \frac{1170}{36.5} = 32.05 \text{ M}$$

84. (d)  $\text{LiHCO}_3$  is unstable and exists only in solution.

85. (d)  $\text{P}_2\text{O}_5$  have great affinity for water, so the final product will be orthophosphoric acid.

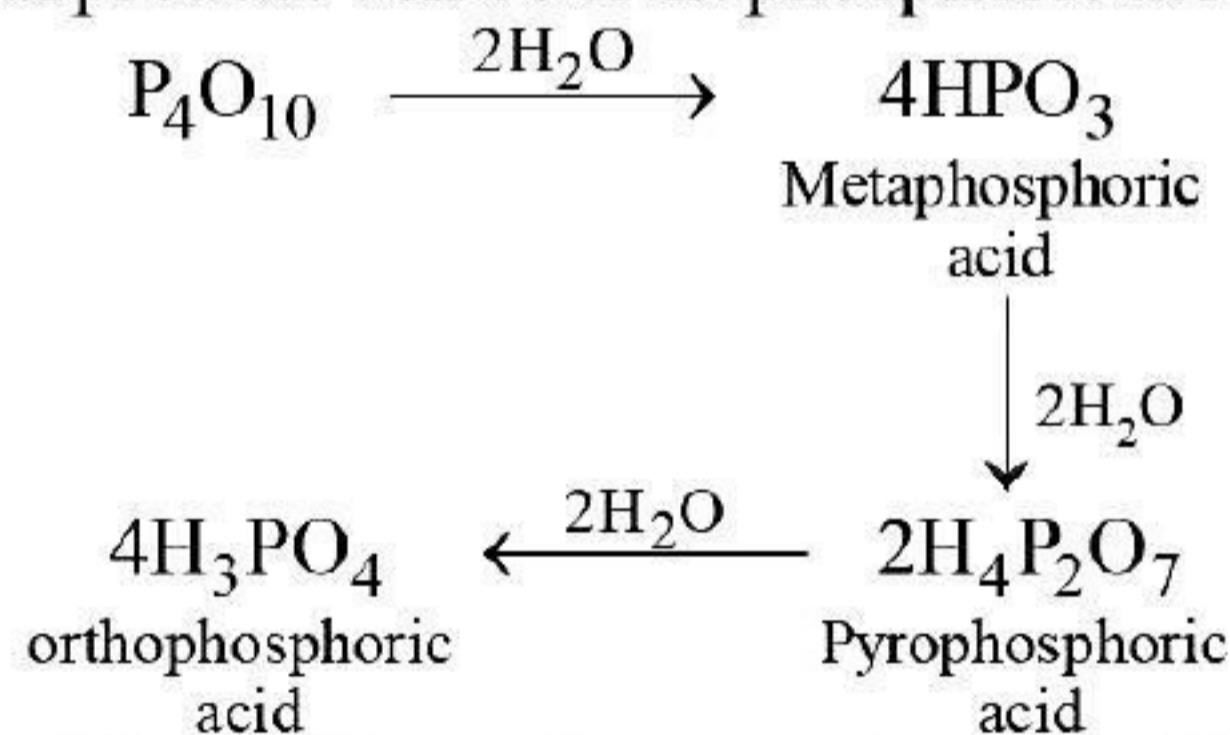

86. (c) The cyclic portion contains more C-atoms than acyclic portion. Hence it is derivative of cyclopentane

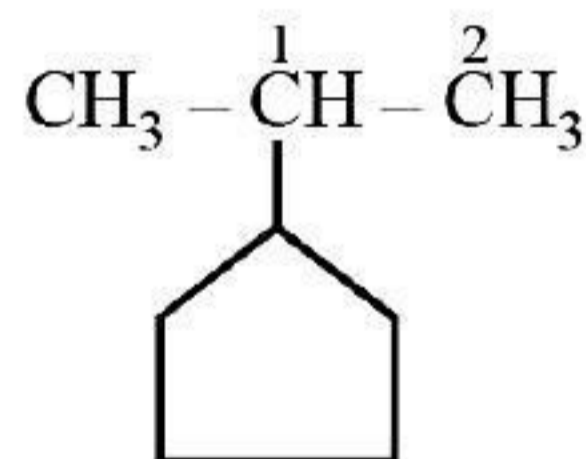

1-(1-methyl)ethyl cyclopentane

87. (a)  $2\text{RCOOK} \xrightarrow[\text{oxidation}]{\text{Electrolytic}} 2\text{RCOO}^- + 2\text{K}^+$   
 Anode Cathode

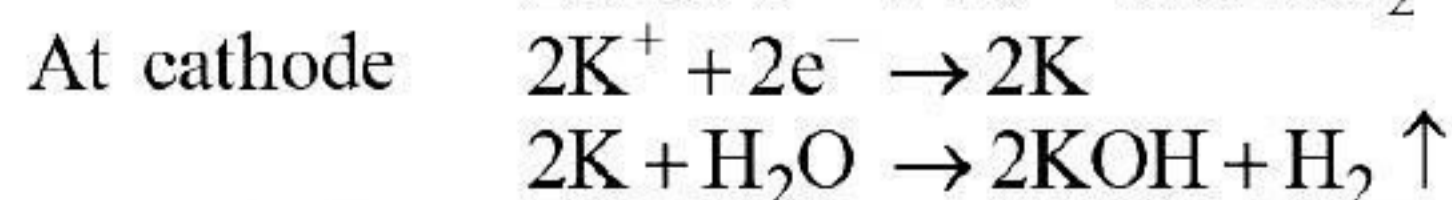
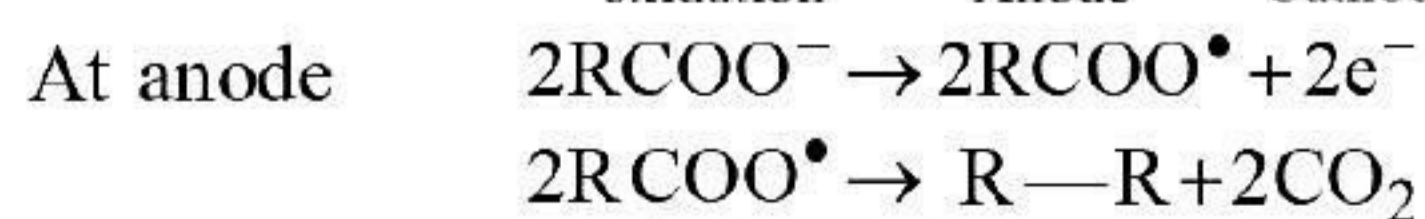

88. (c) The lesser the electronegativity of halogen in  $\text{NX}_3$  the more is the basic character. N can donate more electrons in that case.

89. (d) Both drugs are used as antacids.

90. (d) Since sucrose is dextrorotatory while hydrolysis product of sucrose, having equimolar mixture of glucose and fructose, is laevorotatory. Hence the hydrolysed product of sucrose is known as invert sugar and the hydrolysis of sucrose is known as inversion.

91. (a) This method is very useful for removing all the oxygen and nitrogen present in the form of impurity in certain metals like Zr & Ti.

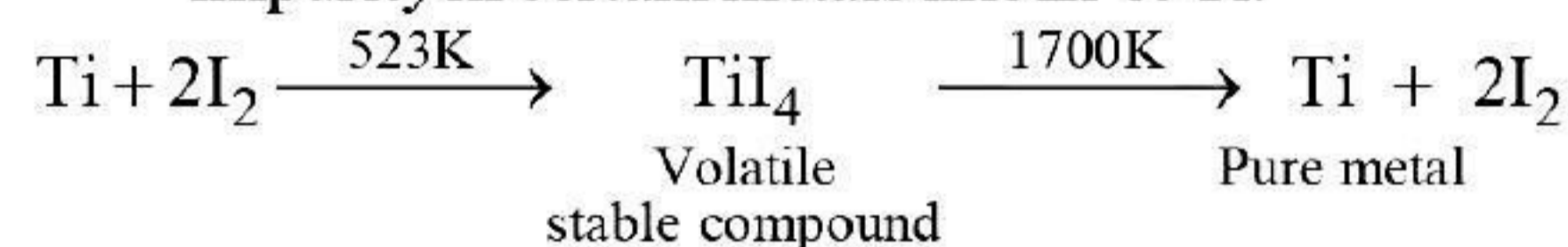

92. (c)  $\text{K}_2\text{Cr}_2\text{O}_7 + 3\text{SO}_2 + 4\text{H}_2\text{SO}_4 \rightarrow$

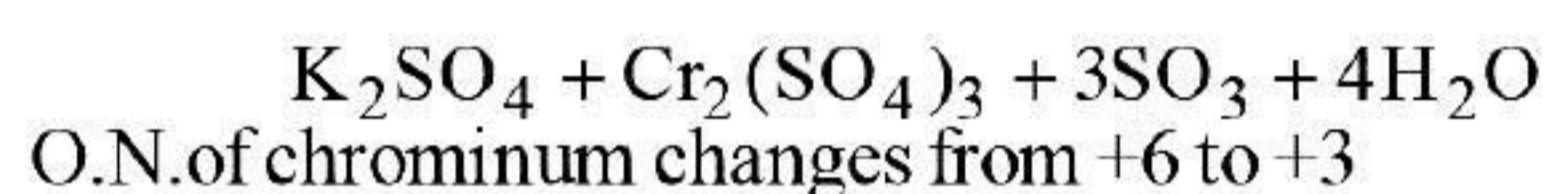

93. (b) High density polythene is used for manufacturing of buckets, dustbins, pipes etc.

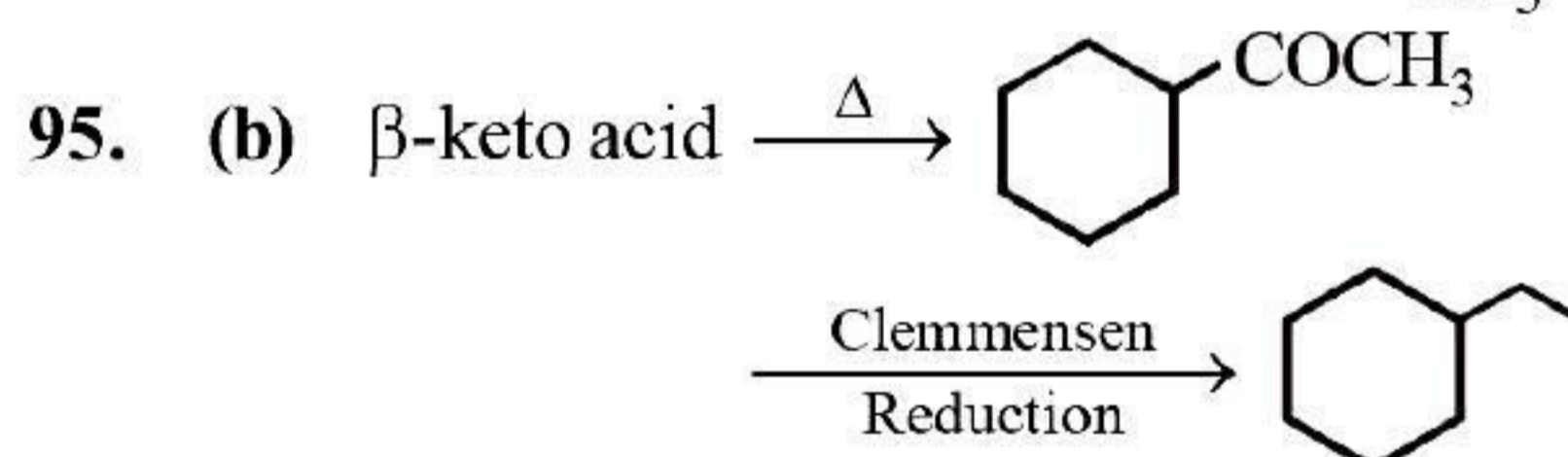
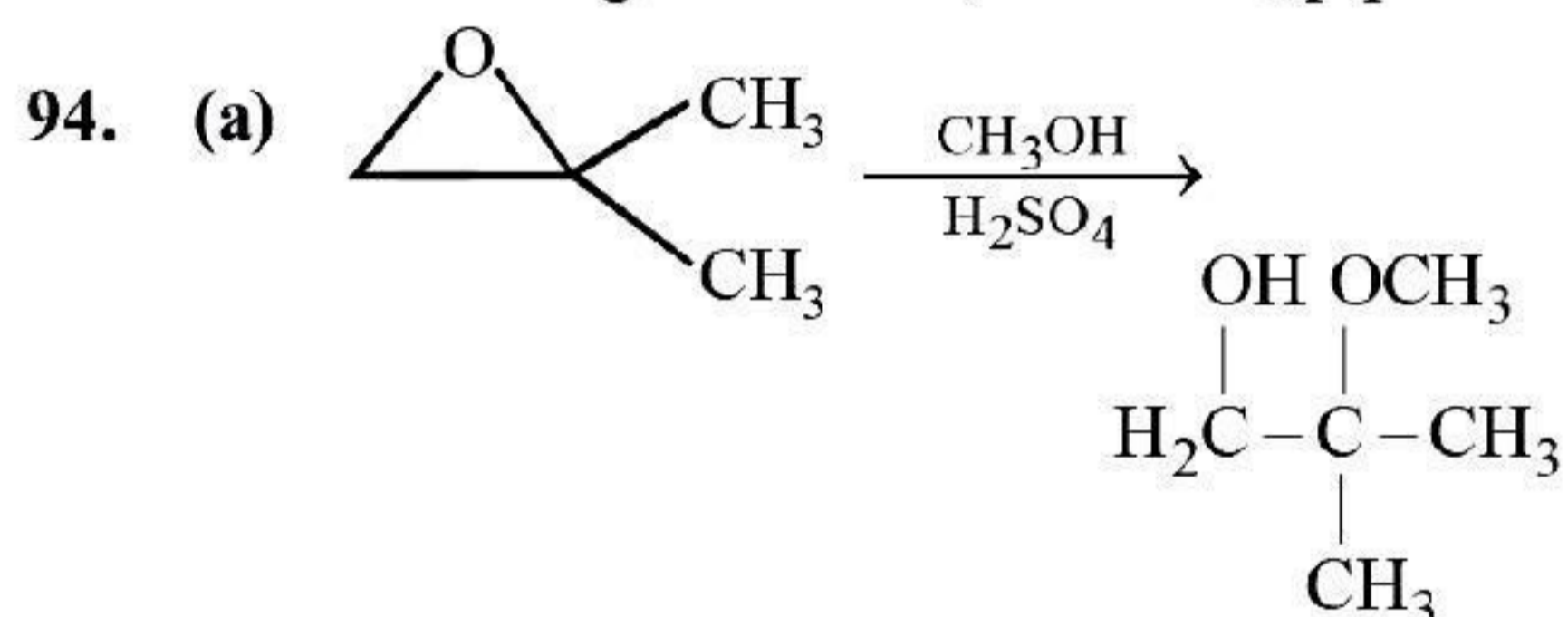

96. (c)  $[\text{PtCl}_2(\text{NH}_3)_4]\text{Br}_2$  and  $[\text{PtBr}_2(\text{NH}_3)_4]\text{Cl}_2$  are ionisation isomers

97. (b) In lanthanides, there is poorer shielding of 5d electrons by 4f electrons resulting in greater attraction of the nucleus over 5d electrons and contraction of the atomic radii.

98. (a) SARAN, a polymer of vinyl chloride ( $\text{CH}_2=\text{CHCl}$ ) and vinylidene chloride, is used for making synthetic hair wigs.

99. (a) Wilkinson's catalyst in  $[\text{RhCl}(\text{PPh}_3)_3]$ , red-violet in colour and has square planar structure. It is used for selective hydrogenation of organic molecules at room temperature and pressure.  $\text{TiCl}_4 + (\text{C}_2\text{H}_5)_3\text{Al}$  is Zeigler Natta catalyst.  $(\text{C}_2\text{H}_5)_4\text{Pb}$  is an anti-knocking agent. *cis*-platin is used as an anti-cancer agent.

100. (a) Work done during adiabatic expansion  
 $= C_v(T_2 - T_1)$   
 or  $-3000 = 20(T_2 - 300) \Rightarrow T_2 = 150\text{K}$

## SECTION-B

### MATHEMATICS

1. (c) We define the following events :  
 $A_1$  : He know the answer  
 $A_2$  : He does not know the answer  
 $E$  : He gets the correct answer  
 Then,  $P(A_1) = 9/10, P(A_2) = 1 - 9/10 = 1/10, P(E/A_1) = 1, P(E/A_2) = 1/4$ .

Therefore, the required probability is

$$P(A_2/E) = \frac{P(A_2)P(E/A_2)}{P(A_1)P(E/A_1) + P(A_2)P(E/A_2)}$$

$$= \frac{\frac{1}{10} \times \frac{1}{4}}{\frac{9}{10} \times 1 + \frac{1}{10} \times \frac{1}{4}} = \frac{1}{37}$$

2. (b)  $\frac{\pi}{2} < x < \pi$  then

$$\sqrt{\frac{1 + \cos 2x}{2}} = |\cos x| = -\cos x$$

$$\therefore \int x \sqrt{\frac{1 + \cos 2x}{2}} dx = -\int x \cos x dx$$

$$= -[x \sin x + \cos x] + c$$

3. (c)  $A = (x_2 - x_1)y$

$$y = 3x_1 \text{ and } y = 30 - 2x_2$$

$$A(y) = \left( \frac{30 - y}{2} - \frac{y}{3} \right) y$$

$$6A(y) = (90 - 3y - 2y)y = 90y - 5y^2$$

$$6A'(y) = 90 - 10y = 0$$

$$\Rightarrow y = 9; A''(y) = -10 < 0$$

$$x_1 = 3; x_2 = 21/2$$

$$\Rightarrow A_{\max} = \left( \frac{21}{2} - 3 \right) 9 = \frac{15 \times 9}{2} = \frac{135}{2}$$

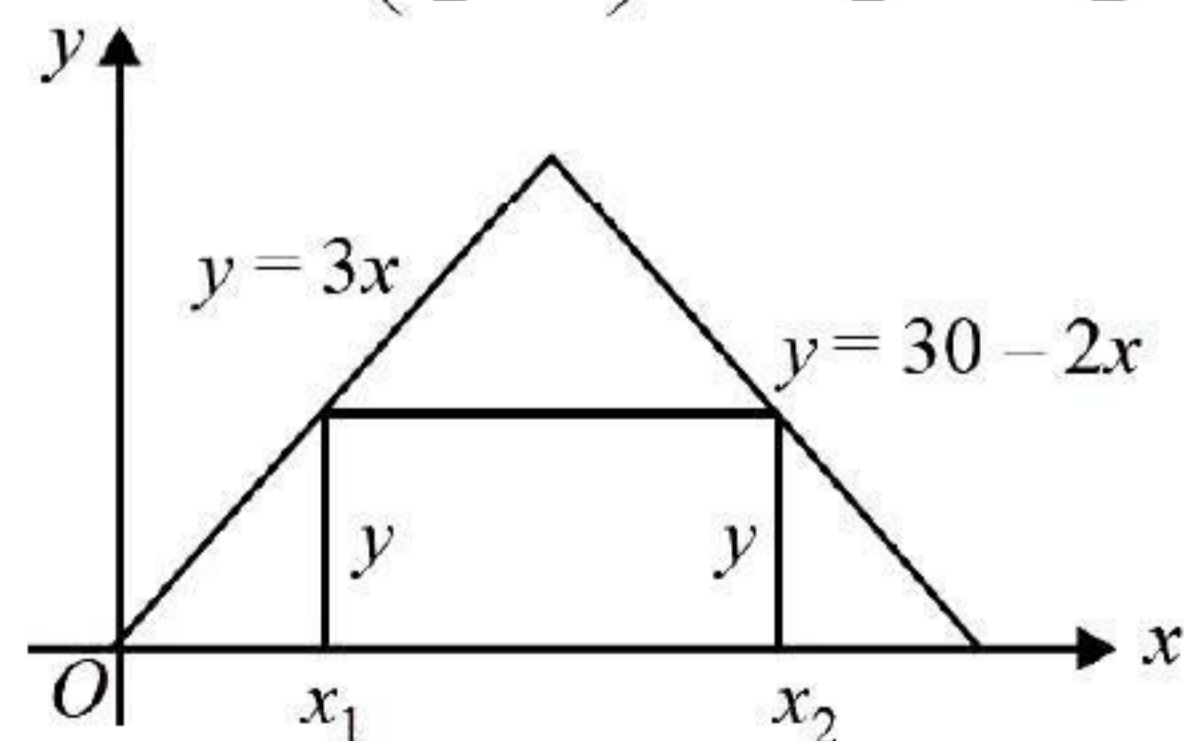

4. (d) We have  $f(x) = 4x^3 - 7, x \in \mathbb{R}$ .  
 $f$  is one-one. Let  $x_1, x_2 \in \mathbb{R}$  and  $f(x_1) = f(x_2)$ .  
 $\Rightarrow 4x_1^3 - 7 = 4x_2^3 - 7 \Rightarrow 4x_1^3 = 4x_2^3$

$$\Rightarrow x_1^3 = x_2^3 \Rightarrow x_1^3 - x_2^3 = 0.$$

$$\Rightarrow (x_1 - x_2)(x_1^2 + x_1x_2 + x_2^2) = 0.$$

$$\Rightarrow (x_1 - x_2) \left[ \left( x_1 + \frac{x_2}{2} \right)^2 + \frac{3x_2^2}{4} \right] = 0.$$

$\Rightarrow x_1 - x_2 = 0$ , because the other factor is non-zero.

$\Rightarrow x_1 = x_2 \quad \therefore f$  is one-one.

$f$  is onto. Let  $k \in \mathbb{R}$  any real number.

$$f(x) = k \Rightarrow 4x^3 - 7 = k \Rightarrow x = \left( \frac{k+7}{4} \right)^{1/3}$$

Now  $\left( \frac{k+7}{4} \right)^{1/3} \in \mathbb{R}$ , because  $k \in \mathbb{R}$  and

$$f \left[ \left( \frac{k+7}{4} \right)^{1/3} \right] = 4 \left[ \left( \frac{k+7}{4} \right)^{1/3} \right]^3 - 7$$

$$= 4 \left( \frac{k+7}{4} \right) - 7 = k$$

$\therefore k$  is the image of  $\left( \frac{k+7}{4} \right)^{1/3}$

$\therefore f$  is onto.

$\therefore f$  is a bijective function.

5. (a)  $\sim((\sim p) \wedge q) \equiv \sim(\sim p) \vee \sim q \equiv p \vee (\sim q)$

6. (c)  $I = \int_1^2 [x^2] dx - \int_1^2 [x]^2 dx$

$$= \int_1^{\sqrt{2}} dx + \int_{\sqrt{2}}^{\sqrt{3}} 2 dx + \int_{\sqrt{3}}^2 3 dx - \int_1^2 1 dx$$

$$= 4 - \sqrt{2} - \sqrt{3}$$

7. (c)  $x(1+y^2)^{1/2} dx + y(1+x^2)^{1/2} dy = 0$

$$\Rightarrow \frac{x dx}{(1+x^2)^{1/2}} + \frac{y dy}{(1+y^2)^{1/2}} = 0$$

Integrating we get

$$2\sqrt{1+x^2} + 2\sqrt{1+y^2} = 2c \text{ or}$$

$$(1+x^2)^{1/2} + (1+y^2)^{1/2} = c$$

8. (c)  $A^2 = \begin{bmatrix} 1 & 0 & 0 \\ 0 & 1 & 0 \\ 0 & 0 & 1 \end{bmatrix} = I_3$

9. (b) Let  $D(x, y, z)$  be the required point, Then, the mid-point of diagonal  $BD$  is

$$\left( \frac{x+1}{2}, \frac{y+2}{2}, \frac{z-4}{2} \right)$$

Also, the mid-point of diagonal AC is

$$\left(\frac{3-1}{2}, \frac{-1+1}{2}, \frac{2+2}{2}\right) \text{ i.e., } (1, 0, 2).$$

But, the mid-points of the diagonals of a parallelogram always coincide.

$$\therefore \frac{x+1}{2} = 1, \frac{y+2}{2} = 0 \text{ and } \frac{z-4}{2} = 2$$

So,  $x = 1, y = -2, \text{ and } z = 8.$

Hence, the required point is  $D(1, -2, 8).$

10. (d) 
$$\int \frac{\sin x + \cos x}{\sqrt{1 - \sin 2x}} dx$$

$$= \pm \int \frac{\sin x + \cos x}{\sin x - \cos x} dx = \pm \log(\sin x - \cos x) + c$$

11. (c) Any plane containing  $\frac{x+1}{-3} = \frac{y-3}{2}$

$$= \frac{z+2}{1} \text{ is}$$

$$a(x+1) + b(y-3) + c(z+2) = 0 \quad \dots (i)$$

$$\text{where } -3a + 2b + c = 0 \quad \dots (ii)$$

If the plane passes through  $(0, 7, -7).$

$$\therefore a + 4b - 5c = 0 \quad \dots (iii)$$

From Eqs. (ii) and (iii),

$$\frac{a}{-10-4} = \frac{b}{1-15} = \frac{c}{-12-2}$$

$$\Rightarrow \frac{a}{1} = \frac{b}{1} = \frac{c}{1}$$

Therefore, the plane (i) becomes

$$(x+1) + (y-3) + (z+2) = 0$$

$$\Rightarrow x + y + z = 0$$

12. (a) The equations of line BC are (using two point form)

$$\frac{x-1}{5-1} = \frac{y-4}{4-4} = \frac{z-6}{4-6} \text{ i.e.,}$$

$$\frac{x-1}{2} = \frac{y-4}{0} = \frac{z-6}{-1}$$

Any point on this line is  $(2t+1, 4, -t+6).$  If this is the foot of perpendicular from A on the line BC, then d.n. of this perpendicular are

$$\langle 2t+1-1, 4-1, -t+6-1 \rangle \text{ i.e. } \langle 2t, 3, -t+5 \rangle$$

Using condition of perpendicularity, we have

$$(2t)(2) + 3 \times 0 + (-t+5)(-1) = 0$$

$$\Rightarrow 5t - 5 = 0 \Rightarrow t = 1.$$

$$\therefore \text{Required foot of perpendicular is } (2+1, 4, -1+6) = (3, 4, 5).$$

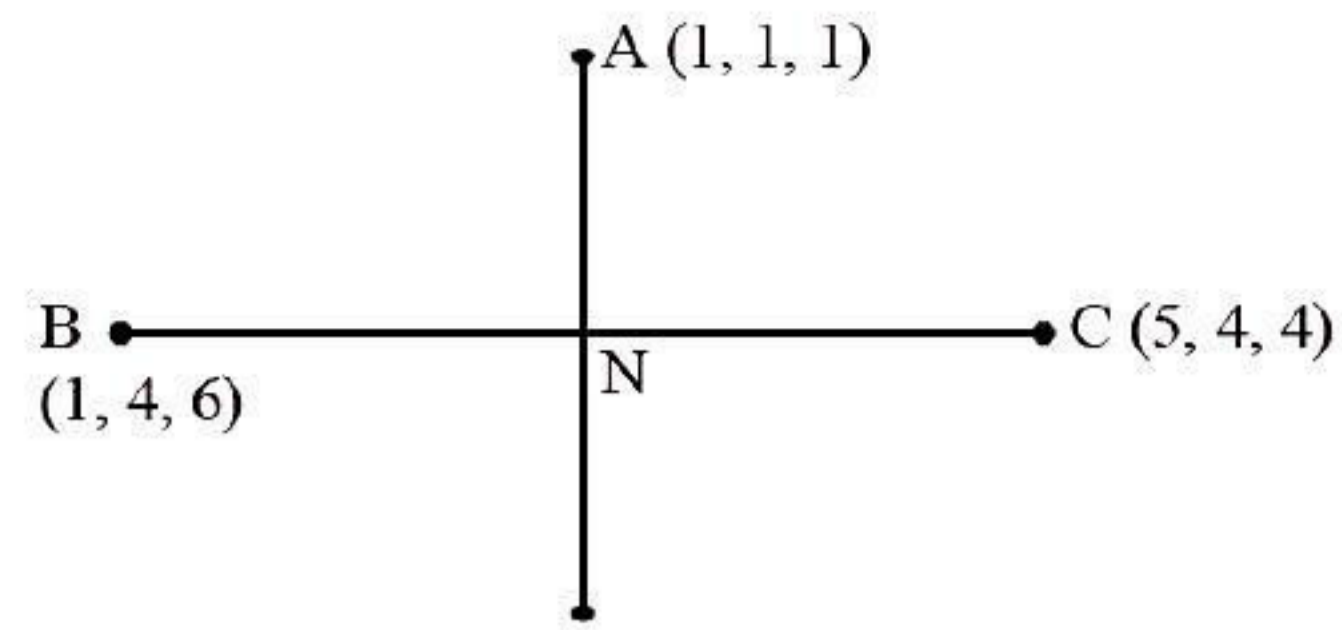

13. (b)  $(p \wedge \sim q) \wedge (\sim p \wedge q) = (p \wedge \sim q) \wedge (\sim q \wedge q)$

$$= f \wedge f = f$$

(By using associative laws and commutative laws)

$\therefore (p \wedge \sim q) \wedge (\sim p \wedge q)$  is a contradiction.

14. (b)  $2^m = 2^n + 56$

$$\Rightarrow 2^m - 2^n = 64 - 8 = 2^6 - 2^3$$

15. (d) For  $x < 1, f(x) = \frac{x^2 - 1}{x^2 + 2x - 3} = \frac{x+1}{x+3}$

$$\therefore \lim_{x \rightarrow 1^-} f(x) = \frac{1}{2}$$

For  $x > 1, f(x) = \frac{x^2 - 1}{x^2 - 2x + 1} = \frac{x+1}{x-1}$

$$\therefore \lim_{x \rightarrow 1^+} f(x) = \infty$$

$\therefore$  The function is not continuous at  $x = 1.$

16. (a) Equation of the line through  $(1, -2, 3)$  parallel to the line  $\frac{x}{2} = \frac{y}{3} = \frac{z-1}{-6}$  is

$$\frac{x-1}{2} = \frac{y+2}{3} = \frac{z-3}{-6} = r \text{ (say)} \quad \dots (i)$$

Then, any point on Eq. (i) is

$$(2r+1, 3r-2, -6r+3).$$

If this point lies on the plane  $x - y + z = 5,$  then

$$(2r+1) - (3r-2) + (-6r+3) = 5$$

$$\Rightarrow -7r + 6 = 5 \Rightarrow r = \frac{1}{7}$$

Since, the point is  $\left(\frac{9}{7}, -\frac{11}{7}, \frac{15}{7}\right).$

Distance between  $(1, -2, 3)$  and  $\left(\frac{9}{7}, \frac{11}{7}, \frac{15}{7}\right)$

$$= \sqrt{\left(\frac{4}{49} + \frac{9}{49} + \frac{36}{49}\right)} = \sqrt{\left(\frac{49}{49}\right)} = 1$$

17. (a) 
$$\int \frac{x + \sin x}{1 + \cos x} dx = \int \frac{x + 2 \sin \frac{x}{2} \cos \frac{x}{2}}{2 \cos^2 \frac{x}{2}} dx$$

$$= \int \left[ \frac{x}{2} \sec^2 \frac{x}{2} + \tan \frac{x}{2} \right] dx$$

$$\begin{aligned}
&= \int x \frac{1}{2} \sec^2 \frac{x}{2} dx + \int \tan \frac{x}{2} dx \\
&= x \tan \frac{x}{2} - \int \tan \frac{x}{2} dx + \int \tan \frac{x}{2} dx + C \\
&= x \tan \frac{x}{2} + C
\end{aligned}$$

18. (b) Here,  $2x + y \leq 30$ ,  $x + 2y \leq 24$ ,  $x, y \geq 0$   
The shaded region represents the feasible region, hence  
 $z = 6x + 8y$ . Obviously it is maximum at  $(12, 6)$ .  
Hence  $z = 12 \times 6 + 8 \times 6 = 120$

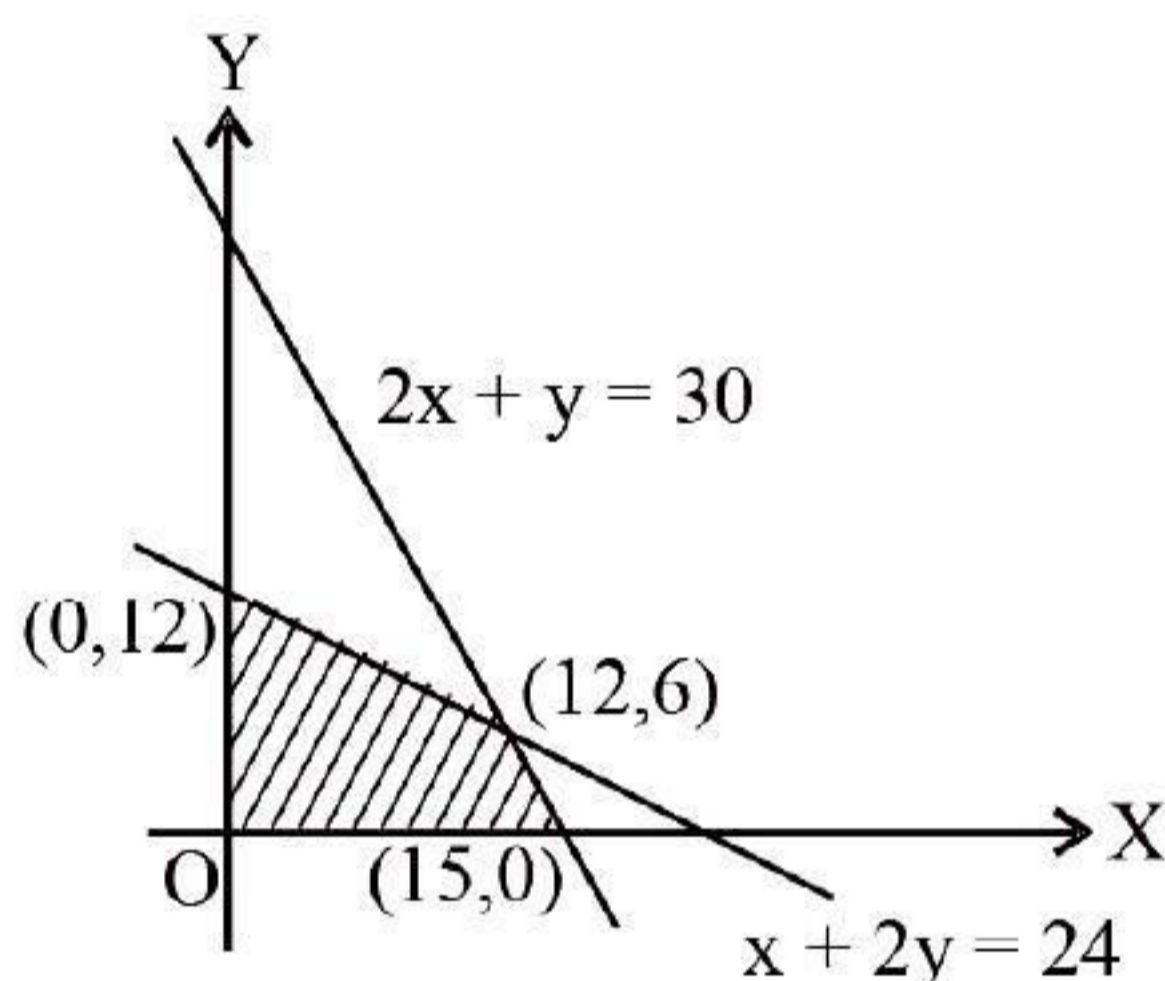

19. (b) In the interval  $\frac{\pi}{3}$  to  $\frac{\pi}{2}$ ,  $[x] = 1$   
 $\therefore I = \int_{\pi/3}^{\pi/2} x \sin(\pi - x) dx = \int_{\pi/3}^{\pi/2} x \sin x dx$   
 $= [-x \cos x + \sin x]_{\pi/3}^{\pi/2} = 1 - \frac{\sqrt{3}}{2} + \frac{\pi}{6}$

20. (b) We write the given equation as  
 $\tan \theta + \tan 4\theta = -\tan 7\theta(1 - \tan \theta \tan 4\theta)$   
 $\Rightarrow \tan(\theta + 4\theta) = -\tan 7\theta \Rightarrow \tan 5\theta = \tan(-7\theta)$   
 $\therefore 5\theta = n\pi + (-7\theta)$  or  $12\theta = n\pi$   
 $\therefore \theta = n\pi/12, n \in \mathbb{I}$

21. (d) We can write the given expression  
 $= \hat{i} \cdot (\vec{p} \times \vec{q}) \hat{i} + \hat{j} \cdot (\vec{p} \times \vec{q}) \hat{j} + \hat{k} \cdot (\vec{p} \times \vec{q}) \hat{k}$   
 $= \vec{p} \times \vec{q}$

Since for any vector  $\vec{a}$ ,  
 $\vec{a} = (\vec{a} \cdot \hat{i})\hat{i} + (\vec{a} \cdot \hat{j})\hat{j} + (\vec{a} \cdot \hat{k})\hat{k}$

22. (a)  $f(\theta) = \sin \theta (\sin \theta + \sin 3\theta)$   
 $= \sin \theta (2 \sin 2\theta \cos \theta)$   
 $= (2 \sin \theta \cos \theta) \sin 2\theta = (\sin 2\theta)^2 \geq 0 \quad \forall \theta \in \mathbb{R}$

23. (c) Change the inequalities into equations and draw the graph of lines, thus we get the required feasible region as shown below.

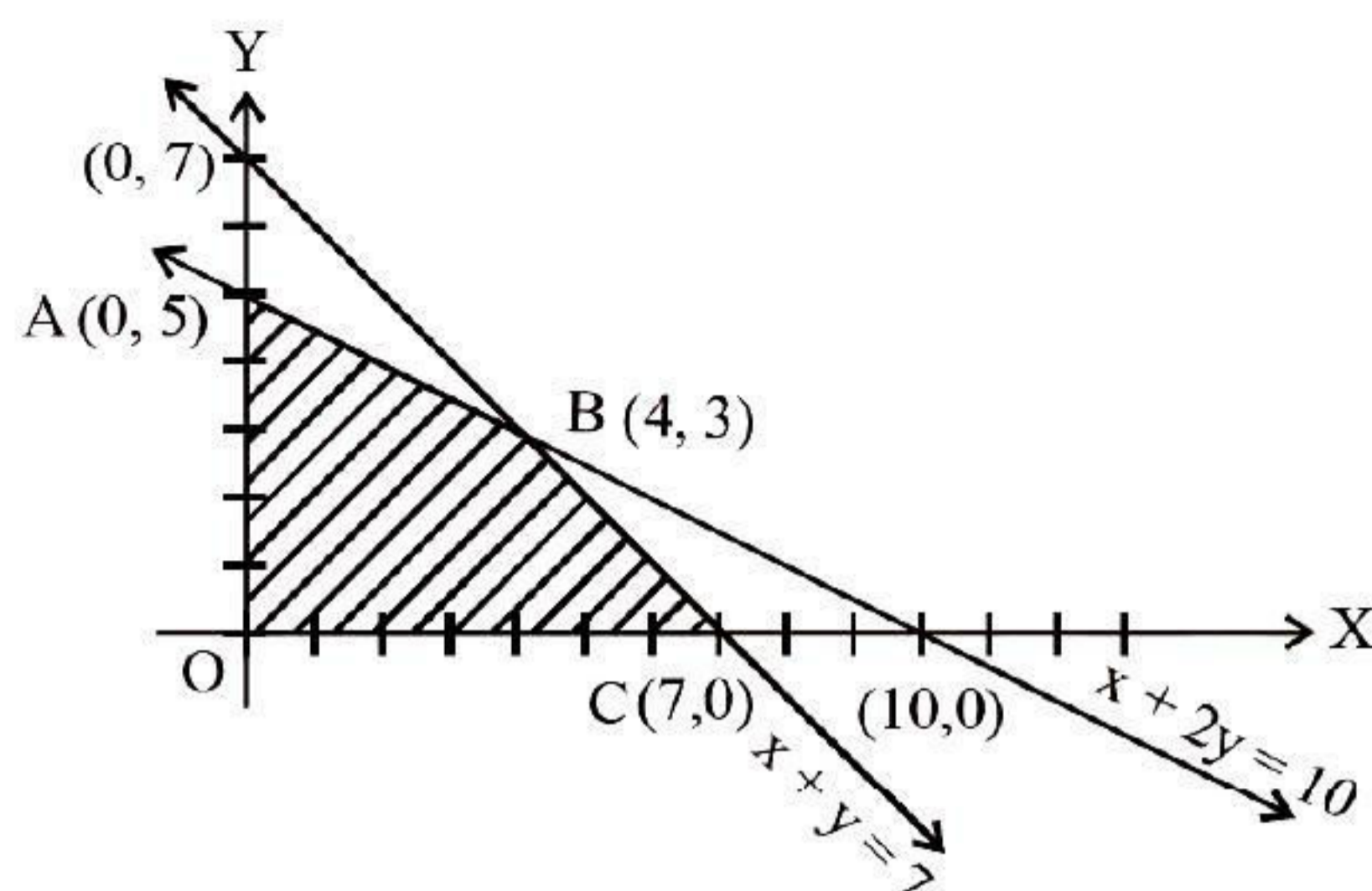

The region bounded by the vertices  
 $A(0, 5), B(4, 3), C(7, 0)$ .  
The objective function is maximum at  $C(7, 0)$  and  
 $\text{Max } z = 5 \times 7 + 2 \times 0 = 35$ .

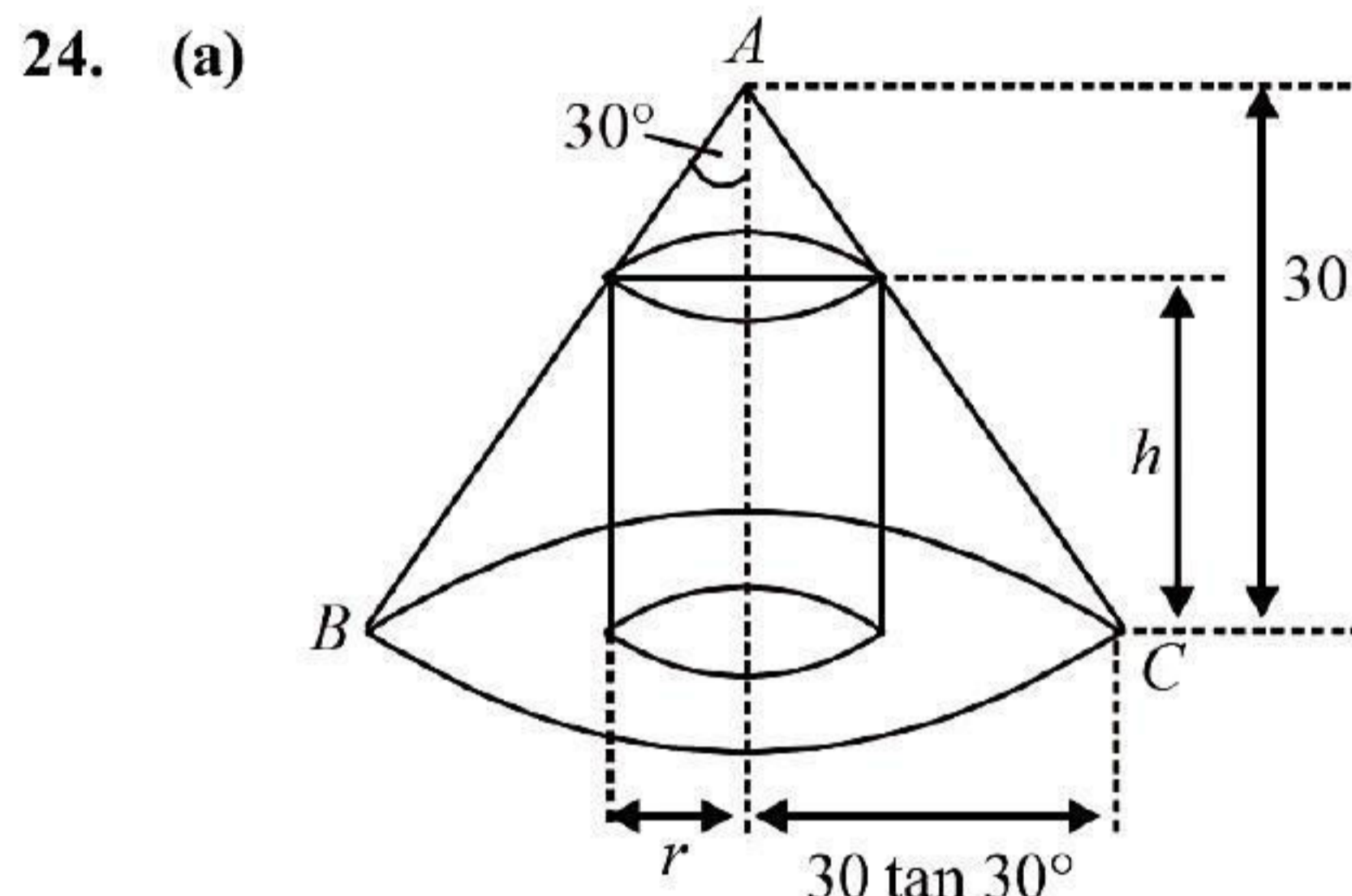

From geometry, we have  $\frac{r}{30 \tan 30^\circ} = \frac{30 - h}{30}$

$$\text{or } h = 30 - \sqrt{3}r$$

Now, the volume of cylinder,

$$V = \pi r^2 h = \pi r^2 (30 - \sqrt{3}r)$$

$$\text{Now, let } \frac{dV}{dr} = 0 \text{ or } \pi(60r - 3\sqrt{3}r^2) = 0$$

$$\text{or } r = \frac{20}{\sqrt{3}}$$

$$\begin{aligned}
\text{Hence, } V_{\max} &= \pi \left( \frac{20}{\sqrt{3}} \right)^2 \left( 30 - \sqrt{3} \frac{20}{\sqrt{3}} \right) \\
&= \pi \frac{400}{3} \times 10 = \frac{4000\pi}{3}
\end{aligned}$$

25. (a) Any plane through the given line  
 $2x - y + 3z + 1 + \lambda(x + y + z + 3) = 0$   
(From  $S + \lambda S' = 0$ )

If this plane is parallel to the line  $\frac{x}{1} = \frac{y}{2} = \frac{z}{3}$ ,  
then the normal to the plane is also perpendicular  
to the above line.

$$\therefore (2+\lambda)1 + (\lambda-1)2 + (3+\lambda)3 = 0$$

$$(\because l_1 l_2 + m_1 m_2 + n_1 n_2 = 0)$$

$$\Rightarrow \lambda = -\frac{3}{2}$$

and the required plane is  $x - 5y + 3z - 7 = 0$ .

26. (c)  $|\vec{a}| = |\vec{b}| = |\vec{c}| = 1$

$$\vec{a} \cdot \vec{b} = (1)(1)\cos\theta = \cos\theta \text{ and}$$

$$\vec{c} \cdot \vec{a} = \cos\theta, \vec{b} \cdot \vec{c} = \cos\theta$$

$$[\vec{a} \vec{b} \vec{c}]^2 = \begin{vmatrix} \vec{a} \cdot \vec{a} & \vec{a} \cdot \vec{b} & \vec{a} \cdot \vec{c} \\ \vec{b} \cdot \vec{a} & \vec{b} \cdot \vec{b} & \vec{b} \cdot \vec{c} \\ \vec{c} \cdot \vec{a} & \vec{c} \cdot \vec{b} & \vec{c} \cdot \vec{c} \end{vmatrix} = \begin{vmatrix} 1 & \cos\theta & \cos\theta \\ \cos\theta & 1 & \cos\theta \\ \cos\theta & \cos\theta & 1 \end{vmatrix}$$

Operate  $R_1 \rightarrow R_1 + R_2 + R_3$

$$= (1+2\cos\theta) \begin{vmatrix} 1 & 1 & 1 \\ \cos\theta & 1 & \cos\theta \\ \cos\theta & \cos\theta & 1 \end{vmatrix}$$

Operate  $C_2 \rightarrow C_2 - C_1; C_3 \rightarrow C_3 - C_1$

$$= (1+2\cos\theta) \begin{vmatrix} 1 & 0 & 0 \\ \cos\theta & 1-\cos\theta & 0 \\ \cos\theta & 0 & 1-\cos\theta \end{vmatrix}$$

$$= (1+2\cos\theta)(1-\cos\theta)^2$$

$$\therefore [\vec{a} \vec{b} \vec{c}] = (1-\cos\theta)\sqrt{1+2\cos\theta}$$

27. (a)  $\sin 2x - \sin 4x + \sin 6x = 0$

$$\Rightarrow (\sin 2x + \sin 6x) - \sin 4x = 0$$

$$\Rightarrow 2\sin 4x \cos 2x - \sin 4x = 0$$

$$\sin 4x = 0 \Rightarrow 4x = n\pi \Rightarrow x = \frac{n\pi}{4}$$

$$2\cos 2x - 1 = 0 \Rightarrow \cos 2x = \frac{1}{2}$$

$$\Rightarrow 2x = 2n\pi \pm \frac{\pi}{3} \text{ or } x = n\pi \pm \frac{\pi}{6}$$

28. (a) Perpendicular distance of directrix from

$$\text{focus} = \frac{a}{e} - ae = 4 \Rightarrow a \left( 2 - \frac{1}{2} \right) = 4 \Rightarrow a = \frac{8}{3}$$

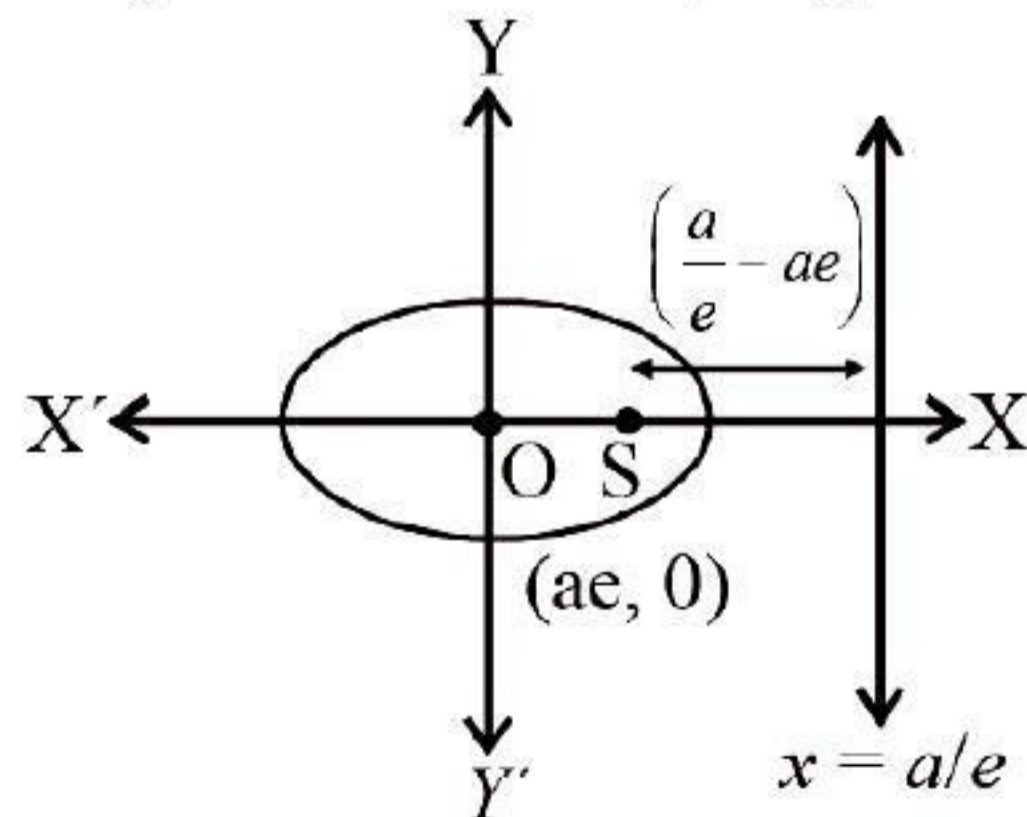

$\therefore$  Semi major axis =  $8/3$

29. (c) For any point  $P(x, y)$  that is equidistant from the given line, we have

$$x + y - \sqrt{2} = -(x + y - 2\sqrt{2})$$

$$\text{or } 2x + 2y - 3\sqrt{2} = 0.$$

30. (a) Let the co-ordinates of A be  $(a, 0)$ . Then the slope of the reflected ray is

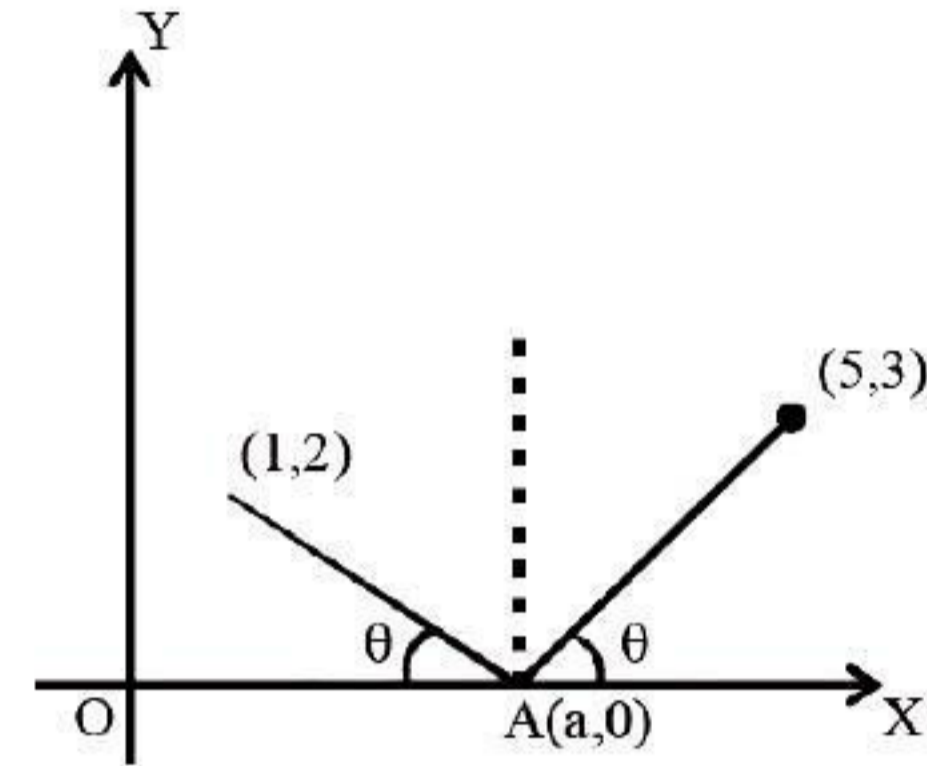

$$\frac{3-0}{5-a} = \tan\theta \text{ (say)} \quad \dots(1)$$

Then the slope of the incident ray

$$= \frac{2-0}{1-a} = \tan(\pi - \theta) \quad \dots(2)$$

from (1) and (2)  $\because \tan\theta + \tan(\pi - \theta) = 0$

$$\Rightarrow \frac{3}{5-a} + \frac{2}{1-a} = 0 \Rightarrow 3 - 3a + 10 - 2a = 0$$

$$\Rightarrow a = \frac{13}{5}$$

Thus, the co-ordinates of A are  $\left(\frac{13}{5}, 0\right)$ .

31. (c) Let  $x^2 = \cos 2\theta \Rightarrow 0 \leq 2\theta < \frac{\pi}{2}$  ( $\because x^2 > 0$ )

$$\text{The expression} = \tan^{-1} \left( \frac{\sqrt{2} \cos\theta + \sqrt{2} \sin\theta}{\sqrt{2} \cos\theta - \sqrt{2} \sin\theta} \right)$$

$$= \tan^{-1} \left( \frac{1 + \tan\theta}{1 - \tan\theta} \right) = \frac{\pi}{4} + \theta = \frac{\pi}{4} + \frac{1}{2} \cos^{-1}(x^2)$$

32. (d)  $y = x^{x^2}, \ln y = x^2 \ln x$

$$\frac{1}{y} \frac{dy}{dx} = 2x \ln x + x^2 \cdot \frac{1}{x} = x(1 + 2 \ln x)$$

$$\frac{dy}{dx} = x^{x^2} \cdot x(1 + 2 \ln x) = x^{x^2+1} (1 + 2 \ln x)$$

33. (b)  $A + B = 180^\circ - C = 90^\circ$

$$a = 2R \sin A, b = 2R \sin B, c = 2R \sin C$$

$$\therefore \frac{a^2 - b^2}{a^2 + b^2} = \frac{\sin^2 A - \sin^2 B}{\sin^2 A + \sin^2 B}$$

$$= \frac{\sin(A+B) \sin(A-B)}{\sin^2 A + \sin^2(90^\circ - A)} \quad [\because A+B=90^\circ]$$

$$= \frac{\sin 90^\circ \sin(A-B)}{\sin^2 A + \cos^2 A} = \sin(A-B)$$

34. (b) From geometry, the sum of all internal angles =  $(n-2) \times 180^\circ$   
 where  $n$  is the number of sides of the polygon.  
 $\therefore \frac{n}{2} [2 \times 120^\circ + (n-1) \times 5^\circ] = (n-2) \times 180^\circ$   
 $\Rightarrow n^2 - 25n + 144 = 0 \Rightarrow (n-16)(n-9) = 0$   
 If  $n = 16$  then the 16<sup>th</sup> internal angle =  $120^\circ + (16-1) \times 5^\circ = 195^\circ > 180^\circ$   
 $\therefore n \neq 16$ . Hence  $n = 9$

35. (a)  $0.4096 = {}^5C_1 p q^4$   
 $0.2048 = {}^5C_2 p^2 q^3$  where  $p+q=1$   
 $\Rightarrow p = \frac{1}{5}, q = \frac{4}{5}$   
 Mean =  $np = 1$

36. (b)  $y = \sin^{-1} \frac{2x}{1+x^2} = \pi - 2 \tan^{-1} x$ , for  $x > 1$   
 or  $\frac{dy}{dx} = -\frac{2}{1+x^2}$   
 or  $\left(\frac{dy}{dx}\right)_{x=\sqrt{3}} = -\frac{2}{1+3} = -\frac{1}{2}$

Also, when  $x = \sqrt{3}$ ,  $y = \pi - 2 \times \frac{\pi}{3} = \frac{\pi}{3}$

Hence, equation of tangent is

$$y - \frac{\pi}{3} = -\frac{1}{2}(x - \sqrt{3}).$$

37. (c) Desired probability =  $P(A) + P(B) - 2P(A \cap B)$   
 and  $P\left(\frac{A}{B}\right) = \frac{P(A \cap B)}{P(B)} = \frac{1}{2}$

38. (a) Put  $\left(1 + \frac{r}{\sqrt{2}}, 2 + \frac{r}{\sqrt{2}}\right)$  in  $x^2 + 4xy + y^2 = 0$ ,

we get  $3r^2 + 9\sqrt{2}r + 13 = 0$  for which product of the roots is  $13/3$ .

39. (b)  $ay + x^2 = 7$ , and  $x^3 = y$  cuts orthogonally.  
 Now

$$\left(\frac{dy}{dx}\right) = -\frac{2x}{a} \text{ and } \left(\frac{dy}{dx}\right) = 3x^2$$

$$\text{or } \left[ \left(-\frac{2x}{a}\right)(3x^2) \right]_{(1,1)} = -1$$

$$\text{or } -\frac{2}{a} \times 3 = -1 \text{ or } a = 6.$$

40. (a)  $\cos [2 \cos^{-1} x + \sin^{-1} x]$   
 $= \cos [\cos^{-1} x + \cos^{-1} x + \sin^{-1} x]$   
 $= \cos [\cos^{-1} x + \pi/2] = -\sin \cos^{-1} x$   
 $= -\sin \sin^{-1} \sqrt{1-x^2} = -\sqrt{1-x^2}$   
 $= -\sqrt{1 - \left(\frac{1}{5}\right)^2} = -\sqrt{\frac{24}{25}} = -\frac{2\sqrt{6}}{5}$

41. (d) Since  $\sim(p \Rightarrow q) \equiv p \wedge \sim q$   
 $\sim(\sim p \Rightarrow q) = \sim p \wedge \sim q$

42. (d) The required area is shown by shaded region

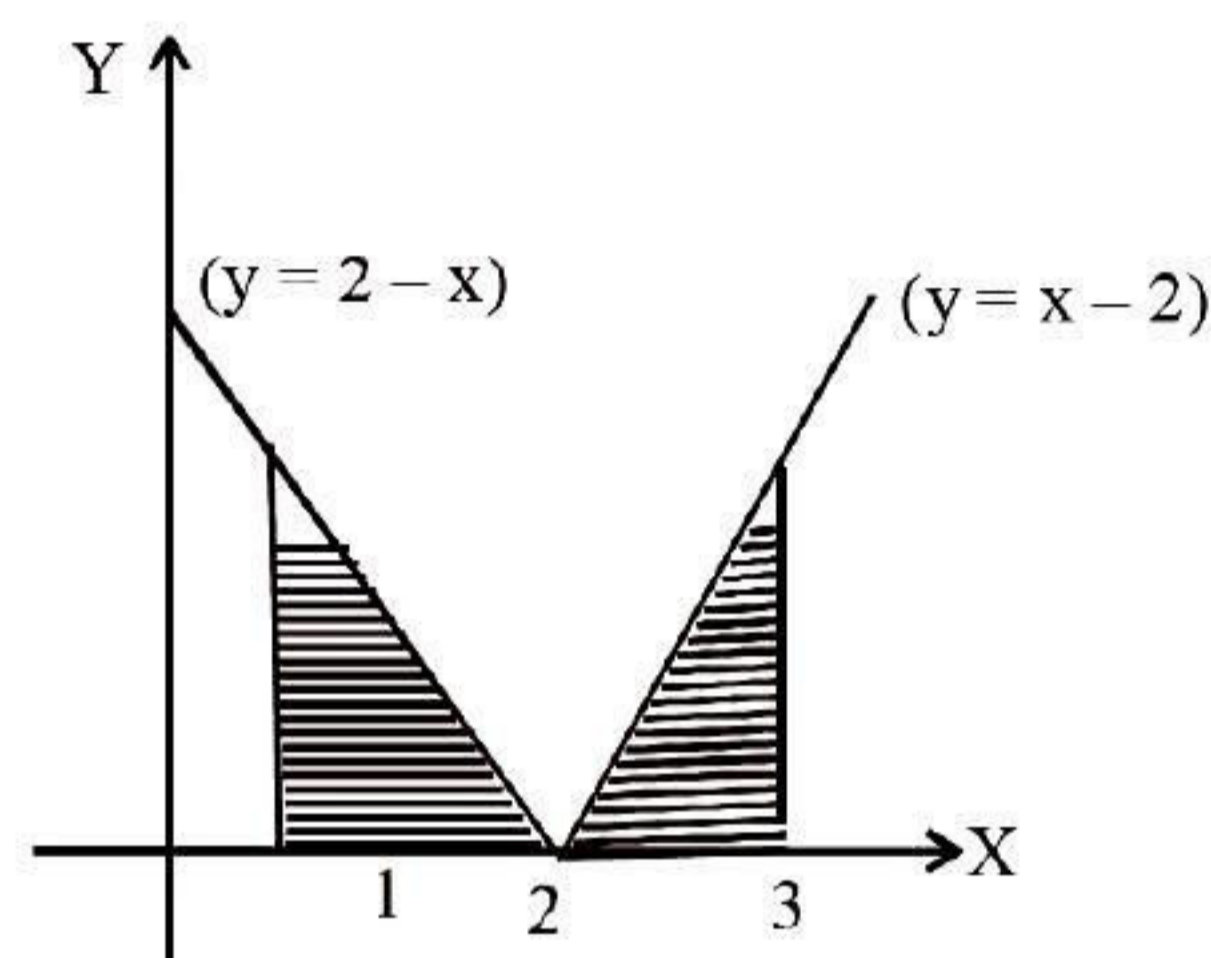

Required Area

$$A = \int_1^3 |x-2| dx = 2 \int_2^3 (x-2) dx$$

$$= 2 \left[ \frac{x^2}{2} - 2x \right]_2^3 = 1$$

43. (c) Given,  $\frac{dy}{dx} = \frac{y}{x} - \cos^2\left(\frac{y}{x}\right)$

Putting  $y = vx$  so that  $\frac{dy}{dx} = v + x \frac{dv}{dx}$

We get,  $v + x \frac{dv}{dx} = v - \cos^2 v$

$$\Rightarrow \frac{dv}{\cos^2 v} = -\frac{dx}{x} \Rightarrow \sec^2 v dv = -\frac{dx}{x}$$

Integrating, we get,  $\tan v = -\ln x + \ln c$

$$\tan\left(\frac{y}{x}\right) = -\ln x + \ln c$$

This passes through  $\left(1, \frac{\pi}{4}\right) \Rightarrow \ln c = 1$

$$\therefore y = x \tan^{-1}\left(\log \frac{e}{x}\right)$$



44. (a) Putting  $n = 99$  and  $p = \frac{1}{2}$ , we have  $(n + 1)p = (100)\left(\frac{1}{2}\right) = 50$

so that the maximum value of  $P(X = r)$  occurs at  $r = (n + 1)p = 50$  and at  $r = (n + 1)p - 1 = 49$

45. (a) Let the progression be  $a, a + d, a + 2d$ ,  
Then  $x_4 = 3x_1 \Rightarrow a + 3d = 3a \Rightarrow 3d = 2a \dots(i)$

Again  $x_7 = 2x_3 + 1$

$\Rightarrow a + 6d = 2(a + 2d) + 1 \Rightarrow 2d = a + 1 \dots(ii)$

Solving (i) and (ii) we get

$a = 3, d = 2$

46. (c) The given equation reduces to

$\frac{(x-1)^2}{9} - \frac{y^2}{3} = 1$ . Thus  $a^2 = 9, b^2 = 3$

Using  $b^2 = a^2(e^2 - 1)$ , we get

$3 = 9(e^2 - 1) \Rightarrow e = \frac{2}{\sqrt{3}}$ .

47. (c)  $2yy_1 = 2c \Rightarrow c = yy_1$

Eliminating  $c$ , we get,  $y^2 = 2yy_1(x + \sqrt{yy_1})$

or  $(y^2 - 2x yy_1)^2 = 4y^3 y_1^3$

It involves only 1st order derivative, its degree is 3 as  $y_1^3$  is there.

48. (a)  $f\{f[f(x)]\} = f\left[f\left(\frac{1}{1-x}\right)\right]$

$= f\left(\frac{1}{1-\frac{1}{1-x}}\right) = f\left(\frac{x-1}{x}\right)$

$\therefore f(x)$  is not defined for  $x = 1$ ;  $f\left(\frac{1}{1-x}\right)$  is not

defined for  $x = 0$ .

$\therefore f\{f[f(x)]\}$  is discontinuous at  $x = 0$  and 1 i.e., there are two points of discontinuity.

49. (c) It is given that  $x = a(\cos t + t \sin t)$  and  $y = (\sin t - t \cos t)$ . Therefore,

$\frac{dx}{dt} = a[-\sin t + \sin t + t \cos t] = at \cos t$

$\frac{dy}{dt} = a[\cos t - \{\cos t - t \sin t\}] = at \sin t$

$\therefore \frac{dy}{dx} = \frac{\left(\frac{dy}{dt}\right)}{\left(\frac{dx}{dt}\right)} = \frac{at \sin t}{at \cos t} = \tan t$

Then,  $\frac{d^2y}{dx^2} = \frac{d}{dx}\left(\frac{dy}{dx}\right)$

$= \frac{d}{dx}(\tan t)$

$= \frac{d}{dt}(\tan t) \frac{dt}{dx}$

$= \sec^2 t \cdot \frac{dt}{dx} = \sec^2 t \cdot \frac{1}{at \cos t}$

$= \frac{\sec^3 t}{at}$

50. (a) The system is  $0x_1 + x_2 - x_3 = 1$

$-x_1 + 0x_2 + 2x_3 = 2$

$x_1 - 2x_2 + 0x_3 = 3$

$\Rightarrow \begin{bmatrix} 0 & 1 & -1 \\ -1 & 0 & 2 \\ 1 & -2 & 0 \end{bmatrix} \begin{bmatrix} x_1 \\ x_2 \\ x_3 \end{bmatrix} = \begin{bmatrix} 1 \\ 2 \\ 3 \end{bmatrix}$  or  $AX = B$

Clearly  $|A| = 0$

Now  $\text{Adj } A = \begin{bmatrix} 4 & 2 & 2 \\ 2 & 1 & 1 \\ 2 & 1 & 1 \end{bmatrix}$

$\therefore (\text{Adj } A) B \neq 0 \Rightarrow$  system is inconsistent