



collegebatch.com

click to campus

GATE 2024 Engineering Sciences (XE) Question Paper

Graduate Aptitude Test in Engineering (GATE)

Download more GATE Previous Year Question Papers: [Click Here](#)

General Aptitude (GA)

Q.1 – Q.5 Carry ONE mark Each

Q.1 If '→' denotes increasing order of intensity, then the meaning of the words [walk → jog → sprint] is analogous to [bothered → _____ → daunted]. Which one of the given options is appropriate to fill the blank?

- (A) phased
- (B) phrased
- (C) fazed
- (D) fused

Q.2 Two wizards try to create a spell using all the four elements, *water*, *air*, *fire*, and *earth*. For this, they decide to mix all these elements in all possible orders. They also decide to work independently. After trying all possible combination of elements, they conclude that the spell does not work. How many attempts does each wizard make before coming to this conclusion, independently?

- (A) 24
- (B) 48
- (C) 16
- (D) 12

- Q.3 In an engineering college of 10,000 students, 1,500 like neither their core branches nor other branches. The number of students who like their core branches is $\frac{1}{4}$ th of the number of students who like other branches. The number of students who like both their core and other branches is 500.

The number of students who like their core branches is

- (A) 1,800
- (B) 3,500
- (C) 1,600
- (D) 1,500

- Q.4 For positive non-zero real variables x and y , if

$$\ln\left(\frac{x+y}{2}\right) = \frac{1}{2}[\ln(x) + \ln(y)]$$

then, the value of $\frac{x}{y} + \frac{y}{x}$ is

- (A) 1
- (B) $\frac{1}{2}$
- (C) 2
- (D) 4

Q.5 In the sequence 6, 9, 14, x , 30, 41, a possible value of x is

(A) 25

(B) 21

(C) 18

(D) 20

GATE 2024

Q.6 – Q.10 Carry TWO marks Each

Q.6 Sequence the following sentences in a coherent passage.

P: This fortuitous geological event generated a colossal amount of energy and heat that resulted in the rocks rising to an average height of 4 km across the contact zone.

Q: Thus, the geophysicists tend to think of the Himalayas as an active geological event rather than as a static geological feature.

R: The natural process of the cooling of this massive edifice absorbed large quantities of atmospheric carbon dioxide, altering the earth's atmosphere and making it better suited for life.

S: Many millennia ago, a breakaway chunk of bedrock from the Antarctic Plate collided with the massive Eurasian Plate.

(A) QPSR

(B) QSPR

(C) SPRQ

(D) SRPQ

- Q.7 A person sold two different items at the same price. He made 10% profit in one item, and 10% loss in the other item. In selling these two items, the person made a total of
- (A) 1% profit
 - (B) 2% profit
 - (C) 1% loss
 - (D) 2% loss

GATE 2024

Q.8 The pie charts depict the shares of various power generation technologies in the total electricity generation of a country for the years 2007 and 2023.

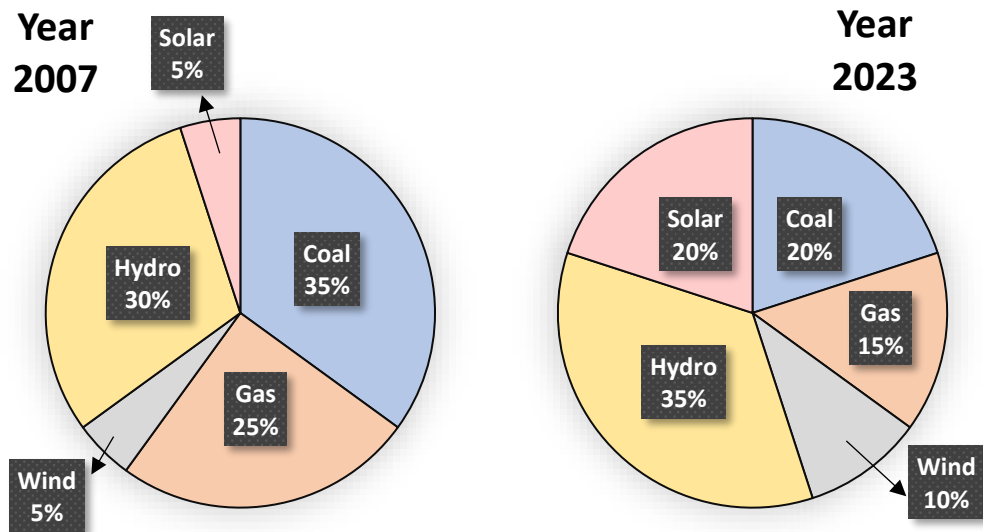

The renewable sources of electricity generation consist of Hydro, Solar and Wind. Assuming that the total electricity generated remains the same from 2007 to 2023, what is the percentage increase in the share of the renewable sources of electricity generation over this period?

- (A) 25%
- (B) 50%
- (C) 77.5%
- (D) 62.5%

Q.9 A cube is to be cut into 8 pieces of equal size and shape. Here, each cut should be straight and it should not stop till it reaches the other end of the cube.

The minimum number of such cuts required is

(A) 3

(B) 4

(C) 7

(D) 8

GATE 2024

- Q.10 In the 4×4 array shown below, each cell of the first three rows has either a cross (X) or a number.

1	X	4	3
X	5	5	4
3	X	6	X

The number in a cell represents the count of the immediate neighboring cells (left, right, top, bottom, diagonals) NOT having a cross (X). Given that the last row has no crosses (X), the sum of the four numbers to be filled in the last row is

- (A) 11
(B) 10
(C) 12
(D) 9

Engineering Mathematics (XE-A)

Q.11 – Q.17 Carry ONE mark Each

Q.11 Let

$$f(x) = \begin{cases} \pi + x, & -\pi \leq x < 0, \\ 0, & 0 \leq x < \pi, \end{cases}$$

with $f(x + 2\pi) = f(x)$. If $F(x)$ represents the Fourier series of $f(x)$, then the value of $F\left(-\frac{\pi}{2}\right) + F(0)$ is

(A) 0

(B) $\frac{\pi}{2}$

(C) π

(D) $\frac{3\pi}{2}$

Q.12 Let y be a non-zero quadratic polynomial satisfying the differential equation

$$(2 + x^2) \frac{d^2y}{dx^2} + x \frac{dy}{dx} - ky = 0,$$

where k is a real constant. If $y(1) = 1$, then the value of the integral

$$\int_0^1 2y \, dx$$

is

- (A) $\frac{1}{3}$
- (B) $\frac{2}{3}$
- (C) 1
- (D) $\frac{4}{3}$

- Q.13 There are four cities, namely, C_1 , C_2 , C_3 and C_4 . The cities are directly connected by four roads as shown in the picture given below, that is, C_1 is connected with C_2 , C_2 is connected with C_3 , C_3 is connected with C_4 , and C_4 is connected with C_1 . The probability of any road getting independently blocked is $\frac{1}{3}$. Let E_1 be the event of travelling from C_1 to C_3 via C_2 and E_2 be the event of travelling from C_1 to C_3 via C_4 . Then, which of the following statements is correct ?

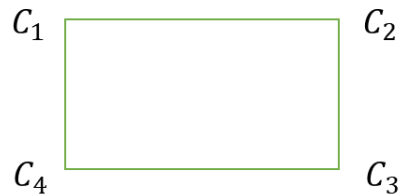

- (A) $P(E_1 \cup E_2) = \frac{56}{81}$
- (B) $P(E_1 \cup E_2) = \frac{8}{9}$
- (C) $P(E_1|E_2) \neq P(E_1) = \frac{4}{9}$
- (D) $P(E_1 \cap E_2) = 0$

- Q.14 Assume that $f: [0, 1] \rightarrow \mathbb{R}$ is continuous on $[0, 1]$ and differentiable on $(0, 1)$ such that $f(x + h) = f(x) + hf'(x + \theta h)$ for some $0 < \theta < 1$. If $f(x) = x^2(1 + x)$, and θ is expressed in terms of x and h , then the value of

$$\lim_{h \rightarrow 0} \theta(x, h)$$

is

- (A) $\frac{1}{3}$
 (B) $\frac{1}{2}$
 (C) $\frac{1}{4}$
 (D) $\frac{4}{5}$

- Q.15 Let A be a 3×3 matrix whose eigenvalues are 2, 3, 4 and let I be the identity matrix of order 3. If

$$A^{-1} = \frac{1}{2k}(A^2 - 9A) + \frac{13}{k}I$$

for some integer $k \neq 0$, then the value of k is _____

- Q.16 For some integer k , the differential equation

$$x^2 \frac{d^2 y}{dx^2} - 3x \frac{dy}{dx} + (k + 2)y = 0$$

is transformed into $(D - 2)^2 y = 0$, where $D = \frac{d}{dt}$ and $t = \log_e x$. Then, the value of k is _____

Q.17 The approximate value (*rounded off to two decimal places*) of the integral

$$\int_0^{1/2} e^{-x^2} dx,$$

using the Trapezoidal rule with step-size $h = \frac{1}{8}$, is _____

GATE 2024

Q.18 – Q.21 Carry TWO marks Each

Q.18 Consider $f(z) = e^z$, where $z = x + iy$ and $i = \sqrt{-1}$. Which of the following statements is correct ?

- (A) f is periodic
- (B) f is not periodic
- (C) $|f| = 1$
- (D) $\arg(f) = y \pm n\pi$ for all $n = 0, 1, 2, \dots$

Q.19 Let P and Q be two square matrices of the same order. Then, which of the following matrices is/are necessarily equal to $(P + 2Q)^2$?

- (A) $P^2 + 4PQ + 4Q^2$
- (B) $P(P + 2Q) + Q(2P + 4Q)$
- (C) $(P + 2Q)(2Q + P)$
- (D) $P^2 + 2PQ + 2QP + 4Q^2$

Q. 20 If

$$\int_0^{\alpha} \int_{\sqrt{x/\alpha}}^1 e^{y^3} dy dx = e - 1, \quad \alpha > 0,$$

then the value (*in integer*) of α is _____

Q. 21 Consider the vector field $\vec{F} = (2x + y^2) \hat{i} + (2xy + 3y) \hat{j}$ and $\alpha_m = \int_{C_m} \vec{F} \cdot d\vec{r}$, $m = 1, 2$, where C_1 is an arc of the unit circle connecting the points $(1, 0)$ and $(0, 1)$ and C_2 is the straight line connecting the points $(1, 0)$ and $(0, 1)$. Then, the value (*in integer*) of $2(\alpha_1^2 + 3\alpha_2^2)$ is _____

Fluid Mechanics (XE – B)

Q.22 – Q.30 Carry ONE mark Each

Q.22 Which one of the following figures shows the CORRECT dependence of apparent viscosity (η) on rate of shear strain (du/dy) for pseudoplastic fluids?

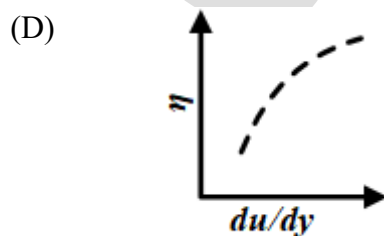
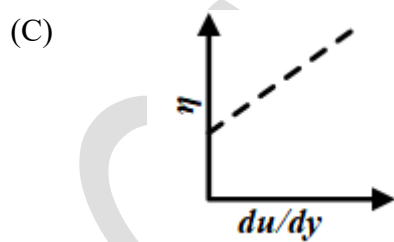
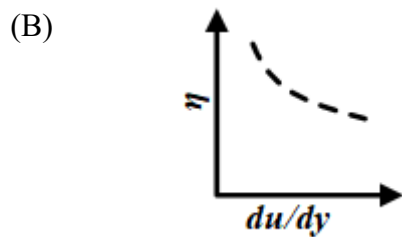
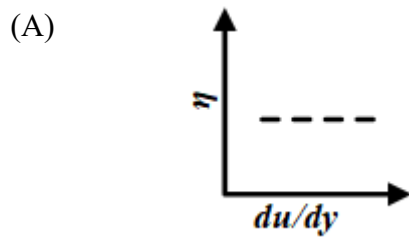

Q.23 The locus of temporary locations of all particles that have passed through a fixed point in the flow field at a particular instant is known as

- (A) streamline.
- (B) streakline.
- (C) pathline.
- (D) timeline.

Q.24 Consider the velocities u, v , and w in x -, y -, and z -directions, respectively. The vorticity expression in the y - z plane is

- (A) $\frac{\partial v}{\partial x} - \frac{\partial u}{\partial y}$
- (B) $\frac{\partial v}{\partial y} - \frac{\partial w}{\partial z}$
- (C) $\frac{\partial w}{\partial y} - \frac{\partial v}{\partial z}$
- (D) $\frac{\partial u}{\partial z} - \frac{\partial w}{\partial x}$

Q.25 For the laminar, incompressible flow over a flat plate with uniform free stream velocity, the axial pressure gradient within the boundary layer is

- (A) greater than zero.
- (B) less than zero.
- (C) equal to zero.
- (D) equal to the axial velocity gradient.

Q.26 Let \vec{r} , \vec{V} , and m be position vector, velocity vector, and mass, respectively in a control mass system. Which one of the following properties is considered as conserved extensive property in Reynolds Transport Theorem to obtain the angular momentum equation?

- (A) $\vec{r} \times m\vec{V}$
- (B) $\vec{r} \times \vec{V}$
- (C) $m\vec{V}$
- (D) m

Q.27 The hydraulic diameter for a circular pipe of radius R is

- (A) $0.5R$
- (B) R
- (C) $2R$
- (D) $4R$

Q.28 For incompressible, laminar, fully-developed flow through a circular pipe, Darcy friction factor and Fanning friction factor are represented as f and C_f , respectively. Which one of the following options is correct?

- (A) $f = 0.25C_f$
- (B) $f = 0.5C_f$
- (C) $f = 2C_f$
- (D) $f = 4C_f$

Q.29 For an immersed neutrally buoyant body to be in stable equilibrium, the center of gravity of the body is directly

- (A) above the metacenter.
- (B) below the metacenter.
- (C) above the center of buoyancy.
- (D) below the center of buoyancy.

Q.30 The absolute pressure in a chamber is measured as 400 mm Hg at a location where the atmospheric pressure is 700 mm Hg. A vacuum gauge connected to the chamber reads _____ mm Hg (*answer in integer*).

Q.31 – Q.43 Carry TWO marks Each

- Q.31 A thin film of an incompressible, Newtonian liquid (density ρ , viscosity μ) with a uniform thickness (h) is flowing down on a vertical plate. The flow is driven by gravity (g) alone. Assume zero shear stress condition at the free surface.

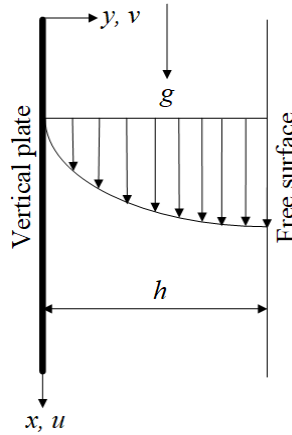

The maximum velocity is given by

- (A) $\frac{1}{2\mu}\rho gh^2$
- (B) $\frac{1}{4\mu}\rho gh^2$
- (C) $\frac{1}{\mu}\rho gh^2$
- (D) $\frac{1}{8\mu}\rho gh^2$

Q.32 A one-eighth scale model of a car is to be tested in a wind tunnel. If the air velocity over the car is 16 m/s, what should be the air velocity (in m/s) in the wind tunnel in order to achieve similarity between the model and the prototype?

- (A) 2
- (B) 16
- (C) 64
- (D) 128

Q.33 A set of basic dimensions, mass, length, and time are represented by M, L, and T, respectively. What will be the dimensions of pressure in M-L-T system?

- (A) $ML^{-1}T^{-2}$
- (B) MLT^{-2}
- (C) MLT^{-1}
- (D) $ML^{-1}T^{-1}$

Q.34 Consider a fluid flow around an airfoil as shown in figure.

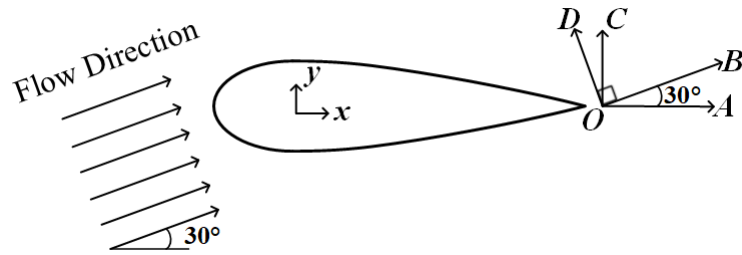

The directions of drag force and lift force, respectively are along

- (A) OA and OC.
- (B) OA and OD.
- (C) OB and OC.
- (D) OB and OD.

- Q.35 A vessel which contains a volatile liquid and its vapour is connected with a mercury manometer as shown in figure. Both the liquid and vapour phases are at equilibrium. The vapour pressure and density of the volatile liquid are 107.6 kPa and 700 kg/m^3 , respectively. The density of the mercury is 13600 kg/m^3 . Acceleration due to gravity (g) is 10 m/s^2 and atmospheric pressure is 101 kPa. Hydrostatic pressure created by the weight of the vapour is neglected.

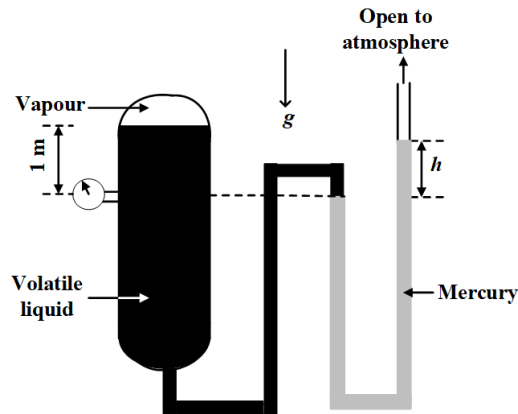

- The height, h (in m, rounded off to two decimal places) of the mercury column in figure is _____.
- Q.36 The velocity in a one-dimensional flow is given by $u(x) = \frac{a}{(b-x)^2}$ m/s, where $a = 8 \text{ m}^3/\text{s}$ and $b = 4 \text{ m}$. The acceleration (in m/s^2 , answer in integer) at $x = 2 \text{ m}$ is _____.
- Q.37 Consider two parallel plates separated by a distance of 1 cm filled with a Newtonian fluid of viscosity $10^{-3} \text{ Pa}\cdot\text{s}$. The top plate is moving with a velocity of 1 m/s whereas the bottom plate is stationary. The shear stress (in Pa, rounded off to one decimal place) on the top plate is _____.

- Q.38 A circular water jet of diameter 50 mm impinges with a velocity of 18 m/s normal to a plate. The density of water is 1000 kg/m^3 and gravity force is neglected.

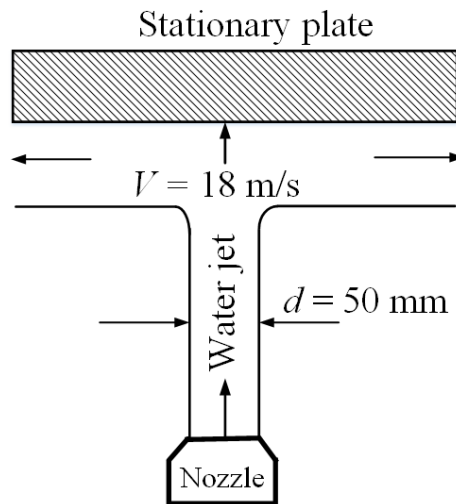

The magnitude of net force (in N, rounded off to two decimal places) imparted by the jet on the stationary plate is _____.

- Q.39 Consider the steady, incompressible flow of water in a horizontal pipe of constant diameter 1 m with an inlet velocity of 12 m/s.

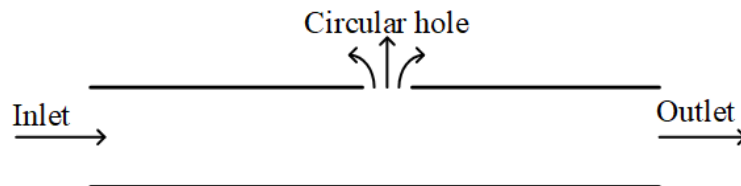

As shown in figure, water is lost through a circular hole of diameter 0.6 m at the rate of $4.53 \text{ m}^3/\text{s}$. The outlet velocity (in m/s, rounded off to two decimal places) of water in the pipe is _____.

- Q.40 The axial velocity profile of a laminar, incompressible and fully-developed flow in a circular pipe of radius (R) is given as $u_z = -\frac{1}{4\mu} \frac{\partial p}{\partial z} R^2 \left(1 - \frac{r^2}{R^2}\right)$, where r , z , μ , and p are radial direction, axial direction, fluid viscosity, and pressure, respectively. If the average velocity of the flow is given by $u_{z,avg} = \frac{1}{K} \left(-\frac{R^2}{\mu} \frac{\partial p}{\partial z}\right)$, then the value of K (answer in integer) is _____.

Q.41 The velocity potential function in a two-dimensional flow field is given by $\phi(x, y) = -(axy + bx^2 - by^2)$ m²/s where $a = 2$ per second and $b = 0.5$ per second. The magnitude of the velocity (in m/s, *answer in integer*) at $x = 2$ m, $y = 1$ m is _____.

Q.42 Consider the incompressible, steady and irrotational flow through a concentric reducer in a horizontal pipeline. The pipe diameter reduces from $d_1 = 12$ cm to $d_2 = 4$ cm as shown in figure. The pressure at position 1 and position 2 of the reducer is $p_1 = 55$ kPa and $p_2 = 27$ kPa, respectively. The specific weight of fluid is 7 kN/m³. Acceleration due to gravity is 10 m/s².

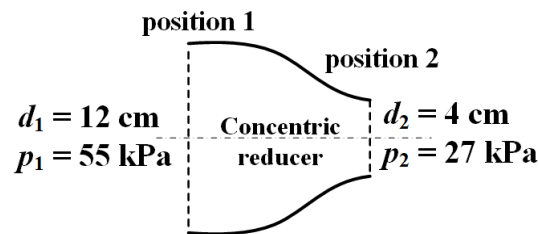

Neglecting frictional effects, the mass flow rate (in kg/s, *rounded off to two decimal places*) of the fluid through the reducer is _____.

Q.43 Consider the incompressible fluid flow over a flat plate with a free stream velocity, $U_\infty = 1$ m/s. The fluid kinematic viscosity is 10^{-6} m²/s and density is 1 kg/m³. The velocity profile within the boundary layer at any location x is given by $u(y) = U_\infty \left(\frac{3y}{2\delta} - \frac{1y^2}{2\delta^2} \right)$, where boundary layer thickness, $\delta = \frac{4.64x}{\sqrt{Re_x}}$. The local wall shear stress at $x = 1$ m from the leading edge is _____ $\times 10^{-3}$ N/m² (*rounded off to two decimal places*).

Materials Science (XE-C)

Q.44 – Q.52 Carry ONE mark Each

Q. 44 The correct combination of phases in the one-component H₂O phase diagram, as given below, is

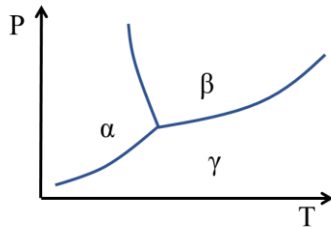

- (A) α – water; β – vapour; γ – ice
- (B) α – ice; β – water; γ – vapour
- (C) α – vapour; β – ice; γ – water
- (D) α – water; β – ice; γ – vapour

Q. 45 Mechanical behaviour of a crystalline ceramic material is best described as

- (A) ductile
- (B) brittle
- (C) viscoelastic
- (D) Viscoplastic

Q. 46 Differential scanning calorimetry involves measurement of

- (A) weight change
- (B) entropy
- (C) heat
- (D) vapour pressure

Q. 47 In ball milling of ceramic powder, selection of grinding media depends on the _____ difference between grinding media and powder particles.

- (A) thermal conductivity
- (B) dielectric constant
- (C) hardness
- (D) density

Q. 48 Which one of the following unit cell parameters represents a tetragonal crystal system?

(A) $a = b = c ; \alpha = \beta = \gamma \neq 90^\circ$

(B) $a \neq b \neq c ; \alpha = \beta = \gamma = 90^\circ$

(C) $a = b \neq c ; \alpha = \beta = 90^\circ, \gamma = 120^\circ$

(D) $a = b \neq c ; \alpha = \beta = \gamma = 90^\circ$

Q. 49 Which of the following types of materials exhibit(s) positive magnetic susceptibility?

(A) Paramagnetic

(B) Diamagnetic

(C) Ferrimagnetic

(D) Ferromagnetic

Q. 50 Which of the following is/are responsible for pitting corrosion in a metal ?

- (A) Rough surface
- (B) Grain boundaries
- (C) Polished surface
- (D) Polymer coated metal surface

Q. 51 In thermogravimetric analysis (TGA), weight change of a material sample during decomposition with temperature is shown in the figure below.

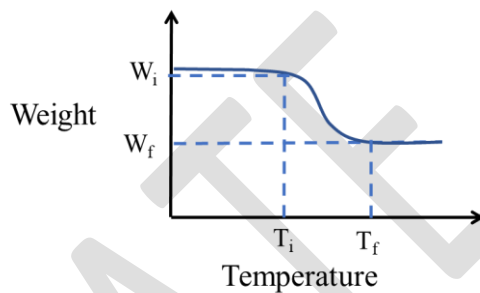

W_i and W_f represent the weight of the material, corresponding to temperatures T_i and T_f , respectively. Which of the following factor(s) can influence T_i and T_f ?

- (A) Heating rate
- (B) Particle size of the material
- (C) Atmosphere in the sample chamber
- (D) Initial weight of the sample

- Q. 52 The work done by a body expanding from an initial state A to the final state B, as shown in the P-V diagram below, is (in units of litre-atm) _____ (rounded off to nearest integer).

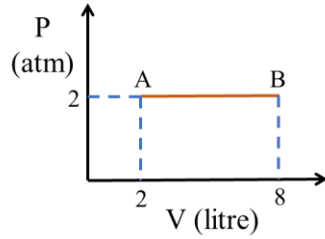

GATE 2024

Q.53 – Q.65 Carry TWO marks Each

Q. 53 A binary phase diagram is given below.

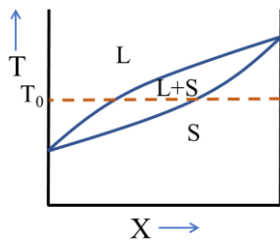

Which one of the following figures qualitatively represents the G-X (Gibbs free energy – composition) plot at temperature T_0 shown in the phase diagram?

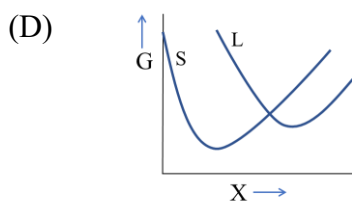
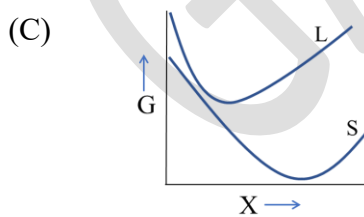
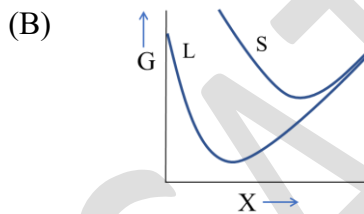
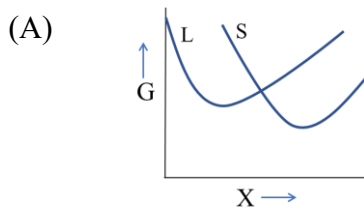

Q.54 Which one of the following figures corresponds to the density of states $g(E)$ of a typical intrinsic semiconductor? (E represents the energy level of a charge carrier)

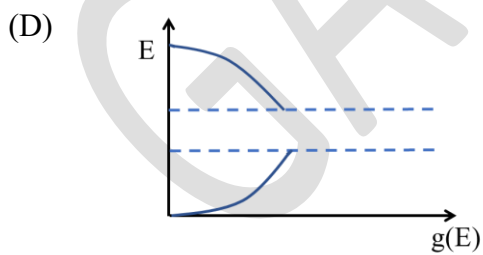
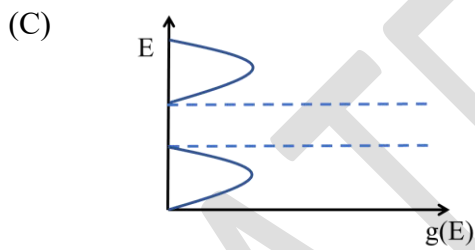
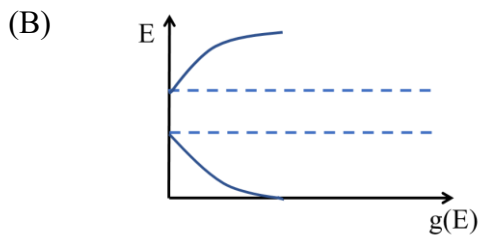
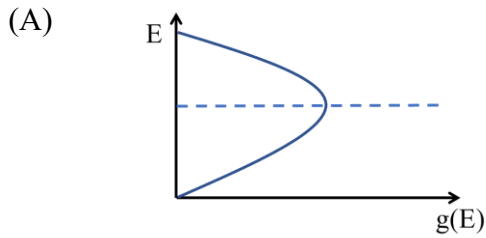

Q. 55 The Miller indices for the shaded plane shown in the unit cell below is

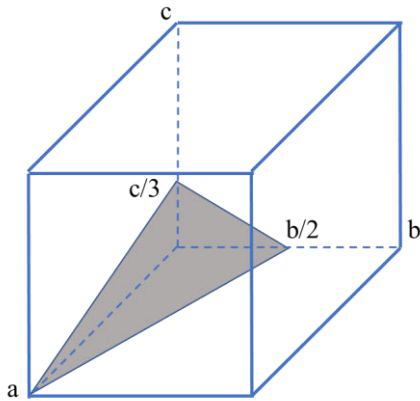

- (A) [632]
- (B) [123]
- (C) (632)
- (D) (123)

GATE 2024

Q. 56 Which one of the following curves best represents the E vs. $f(E)$ behavior of the hot end of a metal rod demonstrating Seebeck Effect? ($f(E)$ is the probability of electron occupancy at an energy state E ; E_F is the Fermi energy)

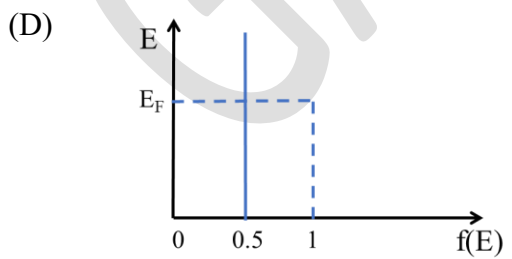
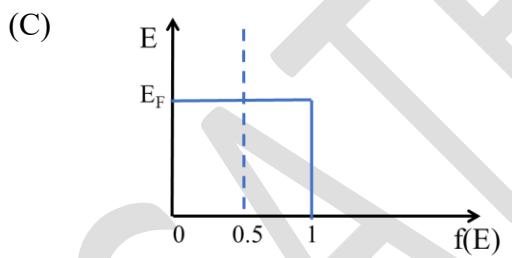
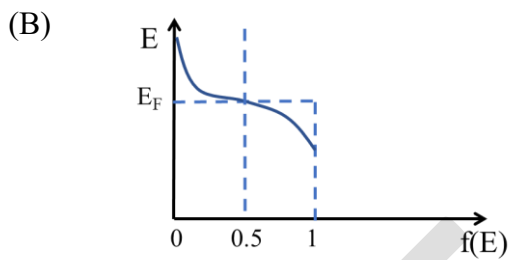
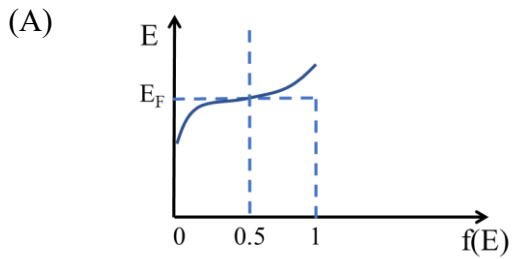

Q. 57 In a typical light emitting diode (LED), which of the following type(s) of materials is/are used?

- (A) Indirect bandgap semiconductor with transition metal impurities
- (B) Direct bandgap semiconductor
- (C) Indirect bandgap semiconductor with isoelectronic impurities
- (D) Indirect bandgap semiconductor without any impurity

Q. 58 Which of the following options is/are true for glass transition temperature T_g ?

- (A) Above T_g , glass transforms from an amorphous solid to a viscous liquid.
- (B) At T_g , glass transforms from an amorphous solid to a crystalline solid.
- (C) T_g is dependent on the heating rate.
- (D) Below T_g , nucleation and growth takes place in glass.

Q. 59 Which of the following figures schematically represent(s) either the Frenkel defect or the Schottky defect in ionic solids?



Q. 60 Given that k is the first order reaction rate constant and T is the temperature in absolute scale, the temperature dependence of rate constant is/are represented by

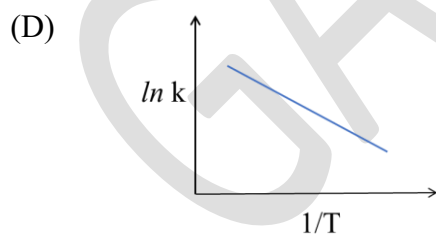
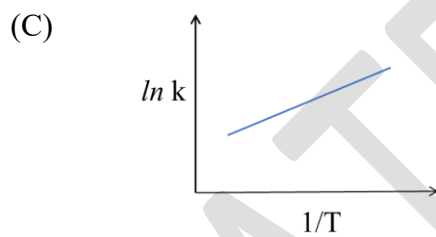
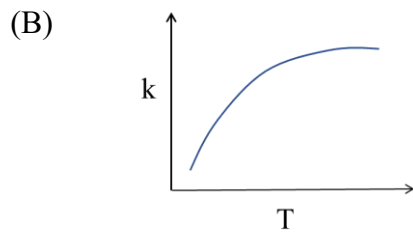
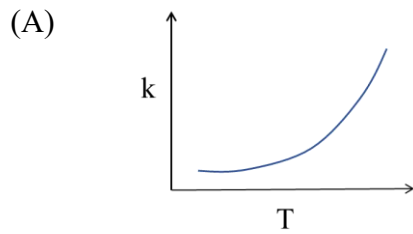

Q. 61 For chemical vapour deposition (CVD) process, which of the following statements is/are correct?

- (A) Target material is stripped off by the bombardment of positive ions
- (B) Source material is vapourized and thermally decomposed
- (C) Partial hydrolysis of alkoxide in water solvent
- (D) Suitable for preparing films of high density and uniform thickness

Q. 62 At room temperature, the electrical conductivity and electron mobility for aluminium are $3.8 \times 10^7 (\Omega \text{ m})^{-1}$ and $0.0012 \text{ m}^2 (\text{V s})^{-1}$, respectively. Density of free electrons for aluminium at room temperature is (in units of m^{-3}) _____ $\times 10^{27}$ (rounded off to nearest integer).

Given: Electrical charge on an electron is $1.6 \times 10^{-19} \text{ C}$.

Q. 63 A 2 mm thick palladium sheet of 1000 mm^2 cross section is used as a diffusional membrane to purify hydrogen. The hydrogen concentration is maintained at a steady state with $c_h = 1.5 \text{ kg m}^{-3}$ and $c_l = 0.3 \text{ kg m}^{-3}$ on the two sides of the membrane as shown in the figure below.

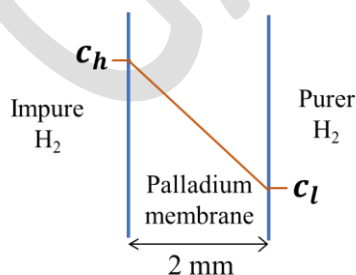

The rate of hydrogen purification is (in units of kg hr^{-1}) _____ $\times 10^{-6}$ (rounded off to one decimal place).

Given: The diffusion coefficient of hydrogen in palladium is $1.0 \times 10^{-8} \text{ m}^2 \text{ s}^{-1}$

Q. 64 In X-ray powder diffraction pattern obtained from a face centered cubic (FCC) metal, the first five reflections are at $\theta = 21.65^\circ, 25.21^\circ, 37.06^\circ, x$ and 47.58° . The Bragg angle, θ of the fourth reflection is missed out and is represented by x . The value of x is (in degree) _____ (rounded off to one decimal place).

Q. 65 Consider a unidirectionally aligned continuous glass fibre reinforced epoxy composite with 40 vol. % reinforcement. The elastic modulus of the composite along the fibre direction is (in units of GPa) _____ (rounded off to one decimal place).

Given: Elastic modulus of epoxy is 6.9 GPa and that of glass fibre is 69 GPa.

GATE 2024

Solid Mechanics (XE-D)

Q.66 – Q.74 Carry ONE mark Each

Q.66 The engineering stress (σ) vs. engineering strain (ϵ) curve obtained by conducting uniaxial tension test on a steel specimen is shown in the figure (the sketched curve is not to the scale). The specimen exhibits cup-and-cone failure within its gage length. Which point on the curve corresponds to the beginning of *necking* in the test specimen?

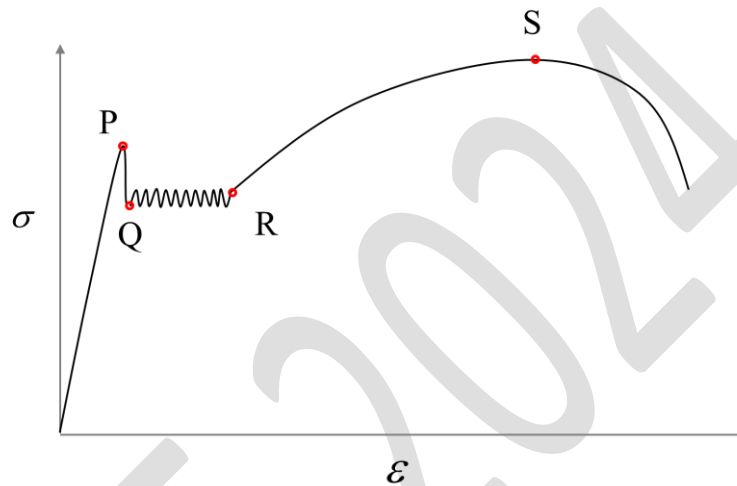

- (A) P
- (B) Q
- (C) R
- (D) S

- Q.67 An L-shaped rigid member is fixed at the midpoint of a simply-supported beam, as shown in figure (i). The member is subjected to a vertically downward force P at its free end. In an equivalent system, the member along with the applied load is replaced with a force $Q = P$ and a moment M (see figure (ii)). Which of the following statements is correct?

(Neglect the mass of the beam and of the rigid member)

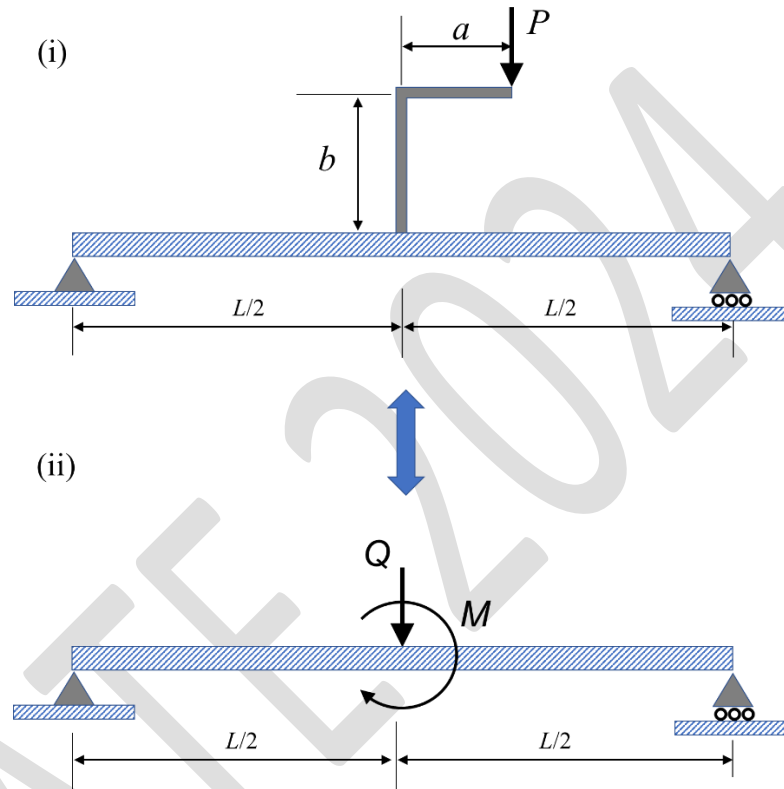

- (A) $M = P a$
 (B) $M = P b$
 (C) $M = P (a + b)$
 (D) $M = 0$

Q.68 A block of weight W , placed on a surface, is subjected to a horizontal force P as shown in the figure. The line of action of force P passes through the center-of-gravity of the block. The magnitude of P is such that the block remains at rest. If N is the resultant normal reaction exerted by the surface, and F is the frictional force acting on the bottom surface of the block, then which of the following represents the correct free body diagram of the block?

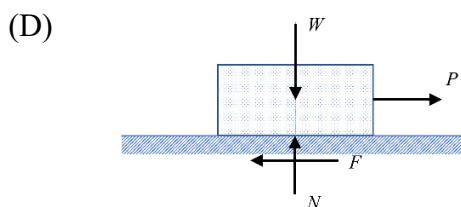
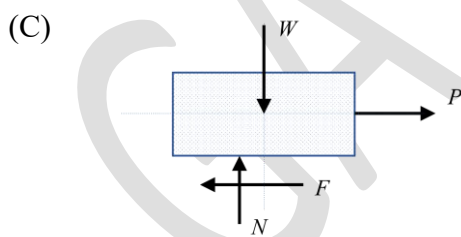
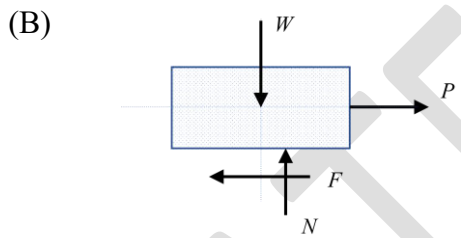
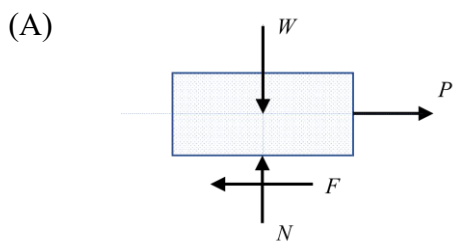
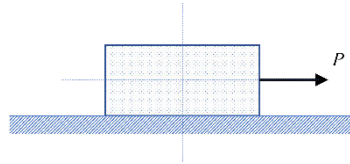

- Q.69 A mass M is hung from a frictionless, massless pulley. The pulley is suspended by using an inextensible, massless rope of which one end is directly fixed to a support, and the other end is connected to the support through a linear spring of stiffness constant k (see figure). The natural frequency of this system is

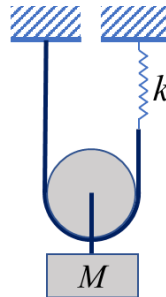

- (A) $\sqrt{\frac{4k}{M}}$
- (B) $\sqrt{\frac{2k}{M}}$
- (C) $\sqrt{\frac{k}{M}}$
- (D) $\sqrt{\frac{k}{2M}}$

- Q.70 A simply-supported beam of rectangular cross-section (width w and height h) is subjected to the loads as shown in the figure (i). The enlarged view of the beam cross-section is shown in figure (ii). The coordinate system is indicated in the figures. Assuming Euler-Bernoulli beam approximation, the shear stress τ_{xz} and normal stress σ_{xx} at the origin, O are respectively given by

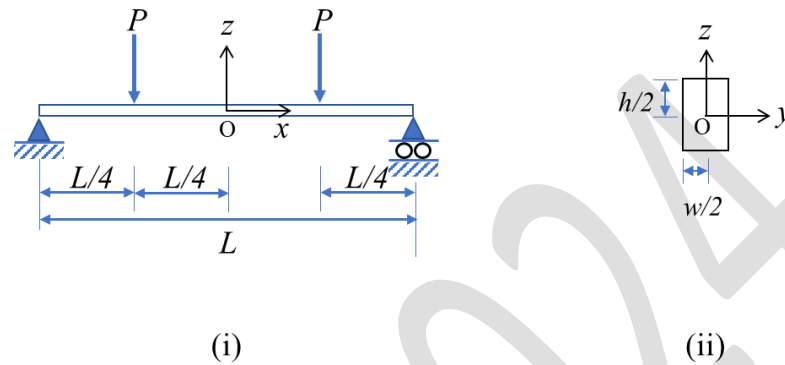

- (A) $\frac{3P}{2wh}$, $\frac{3PL}{2wh^2}$
- (B) 0 , $\frac{3PL}{2wh^2}$
- (C) $\frac{3P}{2wh}$, 0
- (D) 0 , 0

Q.71 An ice-skater starts spinning during her performance. As she retracts her arms and legs closer to her body, her angular velocity _____.

- (A) increases
- (B) decreases
- (C) remains the same
- (D) goes to zero

GATE 2024

Q.72 A solid circular shaft of diameter 100 mm is subjected to a torque 3π kNm. Which of the following statements about the state of stress in the shaft is/are correct?

- (A) The maximum shear stress is 48 MPa
- (B) The maximum tensile stress is 48 MPa
- (C) The magnitude of maximum compressive stress is 48 MPa
- (D) The magnitude of shear stress is 48 MPa at all points in the shaft

Q.73 A spring is connected to an elastic bar as shown in the figure. The spring has a stiffness constant of 10^7 N/m. The bar is 70 mm long, and has an area of cross-section 10 mm^2 . The Young's modulus of the bar material is 70,000 MPa. A force $F = 5000$ N is applied at point O along the axis of the bar and the spring. The resulting deflection of Point O in mm (rounded to one decimal place) is _____

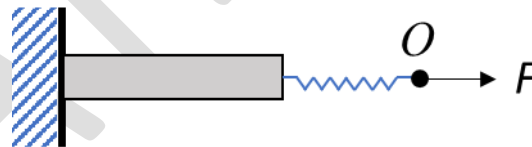

- Q.74 A particle of mass 1 kg is attached to one end of a spring having stiffness of 125 N/m. The free length of the spring is 100 mm. The system is rotated about the other end of the spring at a uniform angular velocity of 5 rad/s. Ignore gravity and consider that the elongation of the spring may be comparable to the free length of the spring. The elongation of the spring (in mm, rounded off to the nearest integer) is _____ .

GATE 2024

Q.75 – Q.87 Carry TWO marks Each

Q.75 A 0-45-90 strain gauge rosette is mounted on an aircraft wing. The co-ordinate system is placed such that the strain gauges p, q and r are oriented at angles 0° , 45° and 90° , respectively, from the x axis (see figure). The strain readings associated to p, q and r are denoted by ϵ_p , ϵ_q , and ϵ_r , respectively. While conducting a test the strain gauges show the following readings.

$$\epsilon_p = 150 \times 10^{-6}, \epsilon_q = 180 \times 10^{-6}, \epsilon_r = -90 \times 10^{-6}$$

The developed engineering shear strain γ_{xy} associated to the strain gauge data is

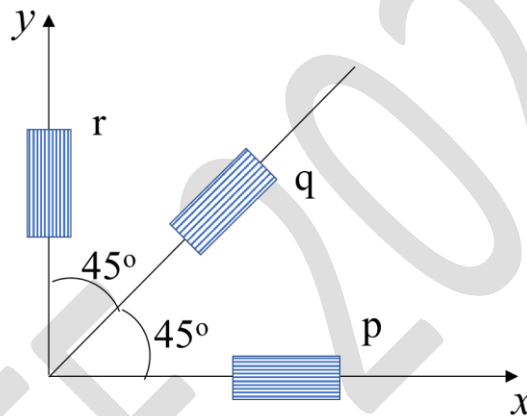

- (A) 120×10^{-6}
- (B) 180×10^{-6}
- (C) 300×10^{-6}
- (D) 240×10^{-6}

- Q.76 A rigid bar PQR is hinged at its end P. As shown in the figure, the bar is pin-connected through two identical links QS and RT at points Q and R, respectively. The other ends of the links, S and T, are fixed. Both links are made of the same material. If the temperature of the links is uniformly increased by ΔT , then which one of the following statements is correct? (Neglect the weight of the rigid bar)

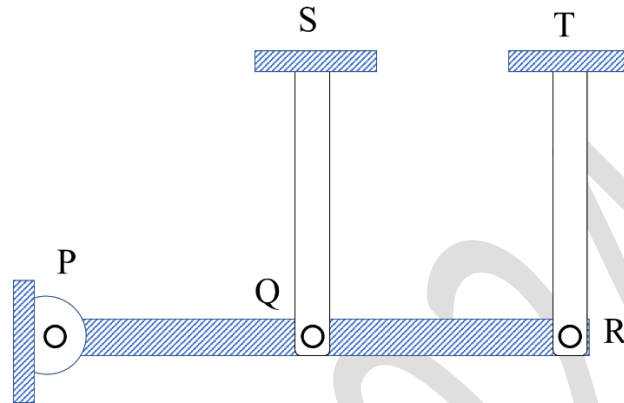

- (A) Both QS and RT will be stress free.
- (B) Both QS and RT will be under tension.
- (C) Both QS and RT will be under compression.
- (D) QS will be under compression and RT will be under tension.

- Q.77 A pin-jointed truss has a pin support at the point E and a roller support at the point F. A horizontal force P is applied at pin H as shown in the figure. Which one of the members is in compression ?

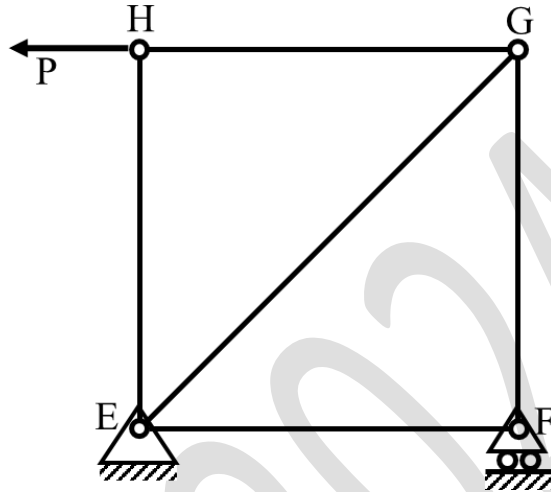

- (A) EF
- (B) FG
- (C) EG
- (D) EH

- Q.78 Two identical rigid slender bars of length $2L$ and mass m are acted upon by a transverse force F at one of the ends as shown in the figure. In the first case, the bar is pinned at the other end. In the second case, the bar is pinned at its mid-point. What should be the magnitude of the force F such that the resulting angular accelerations of the two bars are equal?

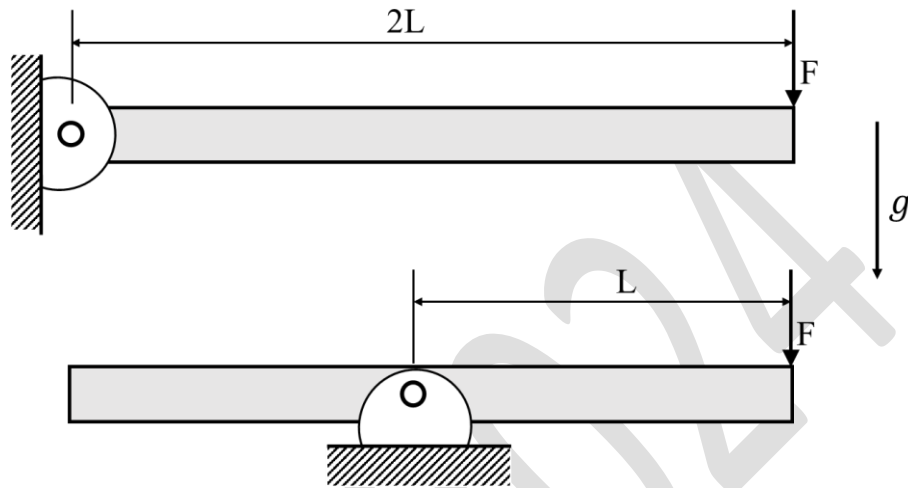

- (A) $m g$
- (B) $\frac{m g}{2}$
- (C) $\frac{m g}{4}$
- (D) $\frac{m g}{6}$

Q.79 A critical point on a component is subjected to the state of stress $[\sigma]$ as given in the following. The yield strength of the material is 400 MPa. By considering maximum shear stress (Tresca) theory, the possible value(s) of σ_0 at the onset of yielding is/are,

$$[\sigma] = \begin{bmatrix} 280 & 0 & 0 \\ 0 & \sigma_0 & 0 \\ 0 & 0 & -60 \end{bmatrix} \text{ MPa}$$

- (A) 340
- (B) 680
- (C) -120
- (D) -460

Q.80 A plane passing through a point Q inside a body is shown. The unit normal of the plane is $\hat{n} = 0.6 \hat{i} + 0.8 \hat{j}$, as shown in the figure. The traction (stress) vector on the plane at point Q is given by $\vec{t} = (50 \hat{i} + 20 \hat{j})$ MPa. Given that at point Q, $\sigma_{xx} = \sigma_{yy}$, the shear stress component τ_{xy} (in MPa, rounded off to two decimal places) is _____.

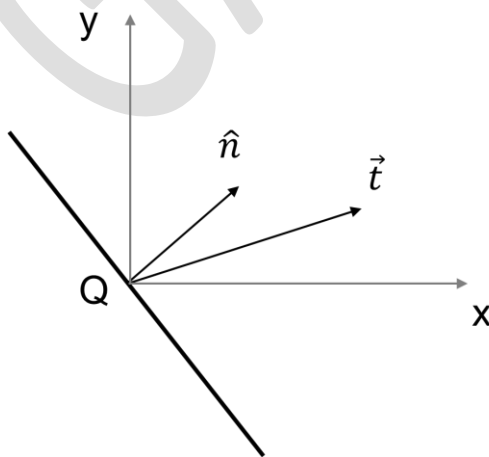

- Q.81 A rigid massless bar PQR is hinged at its end P and supported through a spring of stiffness k at point Q. A vertically downward force $W = 560 \text{ N}$ is applied at the free end R of the bar. If the vertical component of the displacement at R is 30 mm, then the stiffness of the spring (in kN/m, rounded off to one decimal place) is ____.

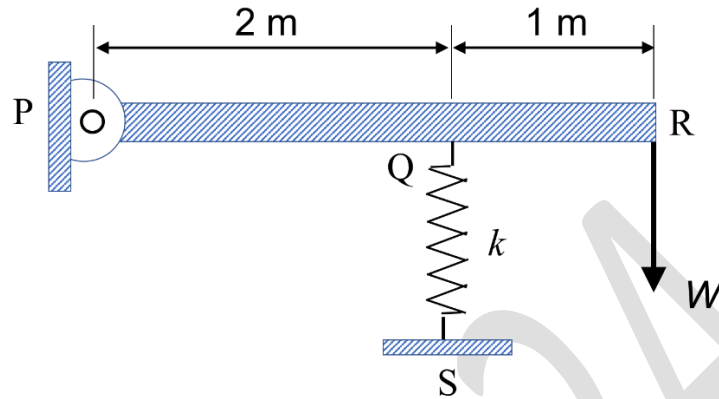

- Q.82 A beam of rectangular cross-section, as shown in the figure, is made of two perfectly bonded layers of different materials and equal thickness. The Young's moduli of the two materials are E_1 and E_2 , where $E_1 = 2E_2$. The beam is subjected to pure bending. If $t = 1 \text{ mm}$, the distance of the neutral plane from the top surface of the beam is ____ (in mm, rounded off to two decimal places).

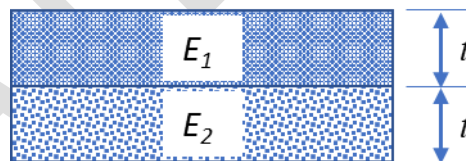

- Q.83 A stepped beam is made of a material whose Young's modulus is E . The dimensions of the two stepped sections are such that the sectional moments of inertia, I_1 and I_2 , are related as $I_1 = 8I_2$. The beam is fixed at one end and a load of F is applied at the free end as shown in the figure. Under this loading condition, if the strain energy of the stepped beam is written as $U = \beta \frac{F^2 L^3}{EI_1}$, then the value of β is _____ (rounded off to two decimal places).

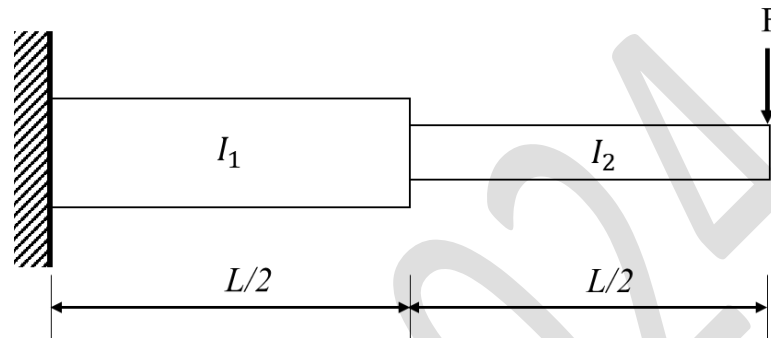

- Q.84 A cylindrical pressure vessel is constructed by bolting two symmetric halves of flanged semi-cylindrical shells. A cross-sectional view of the vessel is shown in the figure. The inner diameter of the vessel is 2 m and the length is 10 m. Each row comprises 100 bolts along the length of the vessel. If the vessel is pressurized to a net pressure of $6 \times 10^5 \text{ N/m}^2$, and assuming the end caps of the vessel do not take any load in the radial direction, then the load borne by each bolt is _____ (in kN, rounded off to one decimal place)

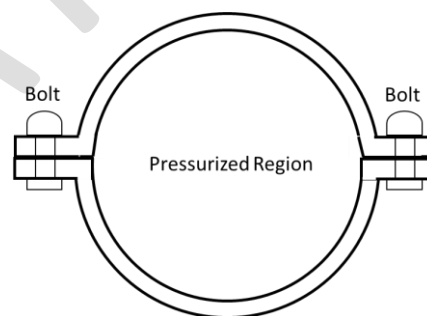

- Q.85 A turn-table is rotating about its center with an angular velocity of 2 rad/s in the counter-clockwise direction. There is a groove in the turn-table within which a marble moves with a constant speed $v \text{ m/s}$ relative to the turn-table. At a given instant, the marble is at a radial distance of 1 m from the center and the line joining the center of the turn-table with the marble makes an angle of 30° with the groove. The value of v (in m/s , rounded off to one decimal place) for which there is no radial acceleration for the marble at this instant is _____.

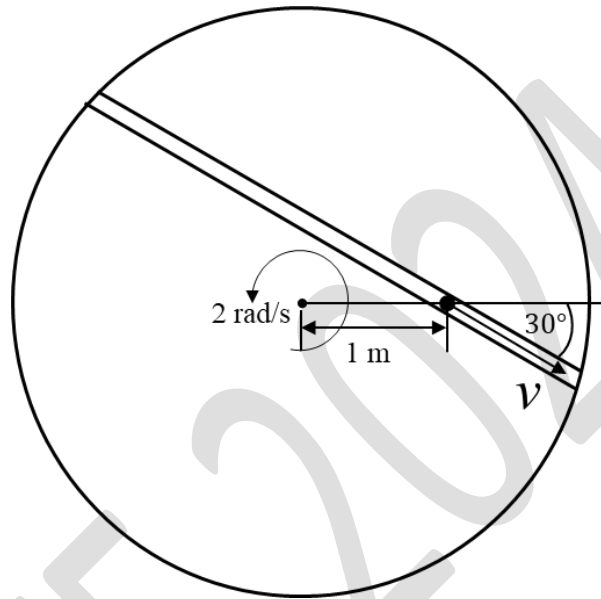

- Q.86 The system shown in the figure is in static equilibrium. The spring is massless and has a spring constant of $K=1 \text{ kN/m}$. The free length of the spring is 1 m . All bodies in the system except the spring are rigid and have mass of $M=1 \text{ kg}$. All surfaces are frictionless and pin joints are ideal. The elongation of the spring (in mm, rounded off to the nearest integer) in this configuration is _____. Take the acceleration due to gravity $g = 10 \text{ m/s}^2$.

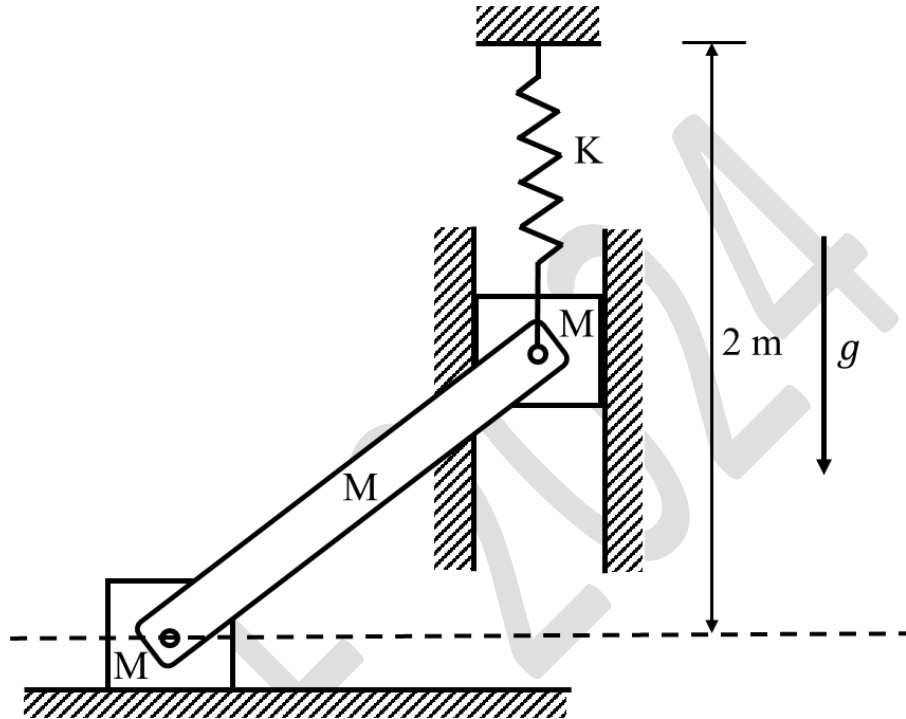

- Q.87 A square block of side 1 m and mass 10 kg is resting on a horizontal surface. The coefficient of static friction between the block and the surface is 0.75 . A horizontal force P acts on the block as shown in the figure. The force P is gradually increased from zero until the block either slides or topples. The maximum value of h (in m, rounded off to two decimal places) for which the block slides without toppling is _____. Take the acceleration due to gravity $g = 10 \text{ m/s}^2$.

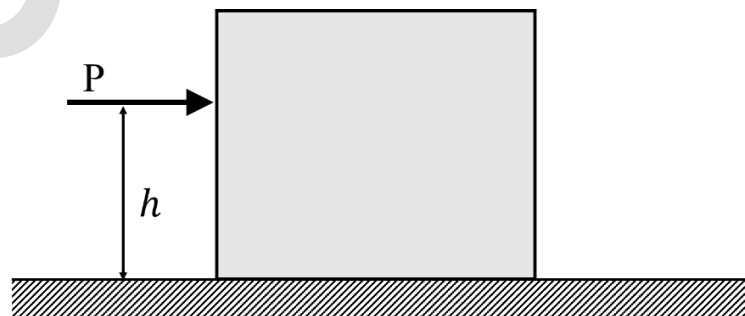

Thermodynamics (XE - E)

Q.88 – Q.96 Carry ONE mark Each

Q.88 A heat source at temperature T_H transfers the *same* amount of heat to a sink under the following situations:

Case A: Sink is at temperature $T_{L,1}$

Case B: Sink is at temperature $T_{L,2}$

If $T_{L,1} < T_{L,2}$, which one of the following statements is TRUE?

- (A) The reversibility is the same, and the entropy generation is greater than zero for Cases A and B
- (B) Case B is less reversible with the entropy generation greater than zero
- (C) Case B is more reversible with the entropy generation greater than zero
- (D) Case B is more reversible with the entropy generation equal to zero

- Q.89 Given v is the molar specific volume, P is the pressure, T is the temperature, R is the Universal gas constant, and a, b are van der Waal's constants.

The van der Waal's equation of state is

$$P = \frac{RT}{v - b} - \frac{a}{v^2}$$

The value of $\left(\frac{\partial v}{\partial T}\right)_P \left(\frac{\partial P}{\partial v}\right)_T \left(\frac{\partial T}{\partial P}\right)_v$ is

- (A) $\frac{a}{b^2}$
- (B) -1
- (C) 1
- (D) $\frac{b^2}{a}$
- Q.90 The temperature of 10 g of liquid water ($c_p = 4.2 \text{ J/g.K}$) in an insulated container is raised by 5 K by stirring. The amount of heat transferred to the water (in J) is

- (A) 210
- (B) 420
- (C) 0
- (D) 105

- Q.91 The figure shows four different processes labeled 1, 2, 3, and 4 for the same closed system containing an ideal gas. The curves labeled T_1 , T_2 , and T_3 are isotherms. For which one of these four processes, the magnitude of internal energy change is the highest?

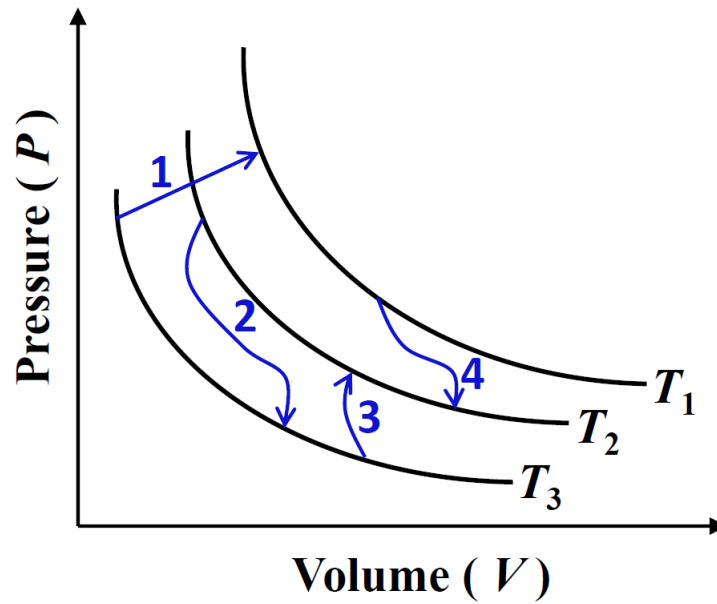

- (A) Process 1
(B) Process 2
(C) Process 3
(D) Process 4

- Q.92 A power plant operates on a simple ideal Rankine cycle. If superheating is added to this cycle, then which one of the following options is CORRECT ?
- (A) Pump work increases, turbine work output increases, cycle efficiency increases, and moisture content at turbine exit increases
 - (B) Pump work remains same, turbine work output increases, cycle efficiency increases, and moisture content at turbine exit increases
 - (C) Pump work remains same, turbine work output increases, cycle efficiency increases, and moisture content at turbine exit decreases
 - (D) Pump work decreases, turbine work output increases, cycle efficiency increases, and moisture content at turbine exit decreases

Q.93 A closed system containing an unknown substance undergoes an adiabatic process governed by the relation $PV^\gamma = \text{constant}$, where P is pressure, V is volume, and γ is the ratio of specific heats. For this scenario, which of the following statements is/are always TRUE?

- (A) The substance is an ideal gas and process is reversible
- (B) The substance is a liquid and process is reversible
- (C) The substance is a non-ideal gas and process is reversible
- (D) The substance is an ideal gas and process is NOT reversible

Q.94 Two rigid, impermeable containers A and B are filled with an ideal gas. They are allowed to exchange heat only with each other and not with the surroundings. P, V, N , and T represent the pressure, total volume, number of moles, and temperature, respectively. At equilibrium, which of the following conditions is/are necessarily satisfied?

(Subscripts A and B represent properties of the gas in the respective containers.)

(A) $P_A = P_B$

(B) $T_A = T_B$

(C) $\frac{P_A V_A}{N_A} = \frac{P_B V_B}{N_B}$

(D) $\frac{P_A}{V_A} = \frac{P_B}{V_B}$

Q.95 Following data is for an actual vapour compression refrigeration cycle.

Enthalpy at compressor inlet: 246 kJ/kg

Enthalpy at compressor exit: 286 kJ/kg

Heat load on the evaporator: 158 kJ/kg

The enthalpy at the exit of the condenser in kJ/kg is _____ (rounded off to the nearest integer).

- Q.96 A rigid tank, initially at 1 bar and 300 K, contains 5 moles of O_2 , 4 moles of N_2 , and 3 moles of H_2 . From this tank, 2 moles of O_2 are removed keeping the temperature constant. Assuming ideal gas behaviour, the final partial pressure of O_2 (in bar) inside the tank is _____ (rounded off to three decimal places).

Use $R = 8.314 \text{ J/mol.K}$

Molecular weights of H_2 , N_2 and O_2 are 2 g/mol, 28 g/mol, and 32 g/mol respectively.

GATE 2024

Q.97 – Q.109 Carry TWO marks Each

Q.97 A fixed mass of an ideal gas undergoes two different cycles **M** and **N** as shown in the Pressure (P) – Volume (V) diagrams. Based on the information provided, which one of the following statements is always TRUE ?

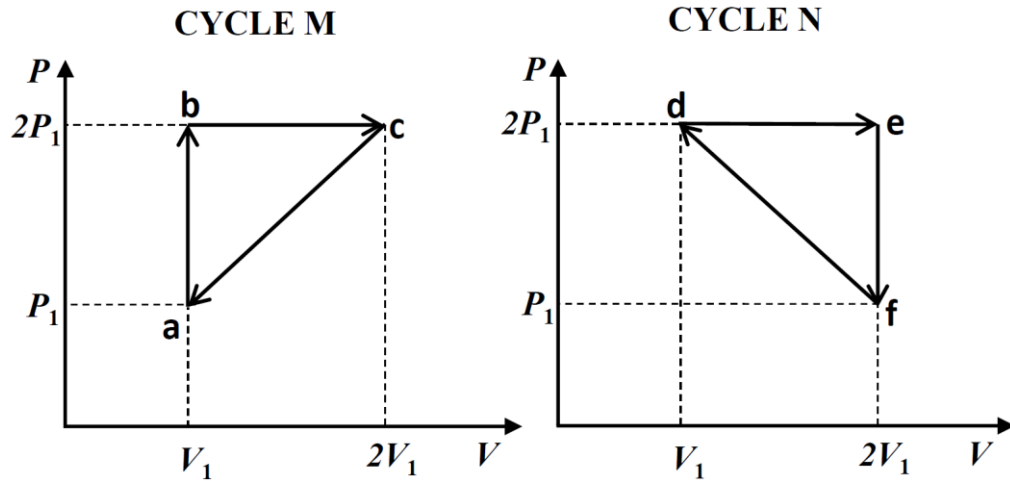

- (A) Heat input in Cycle M is equal to heat input in Cycle N
- (B) Heat rejected in Cycle M is equal to heat rejected in Cycle N
- (C) Net heat transfer in Cycle M is equal to net heat transfer in Cycle N
- (D) Thermal efficiency of Cycle M is equal to thermal efficiency of Cycle N

Q.98 In a graph with Helmholtz function on the y -axis and volume on the x -axis, the slope of the isothermal curves for a finite volume system containing an ideal gas is

- (A) always zero
- (B) infinite
- (C) finite, positive, and non-zero
- (D) finite, negative, and non-zero

GATE 2024

Q.99 Match each quantity in **Column M** with the appropriate relation from **Column N**. Here, ψ is Helmholtz function, P is pressure, v is specific volume, T is temperature, h is specific enthalpy, and S is specific entropy.

Column M		Column N	
(M1)	v	(N1)	$-\left.\frac{\partial\psi}{\partial v}\right _T$
(M2)	P	(N2)	$\left.\frac{\partial\psi}{\partial v}\right _T$
(M3)	s	(N3)	$\left.\frac{\partial\psi}{\partial T}\right _v$
(M4)	T	(N4)	$-\left.\frac{\partial\psi}{\partial T}\right _v$
		(N5)	$\left.\frac{\partial h}{\partial P}\right _s$
		(N6)	$-\left.\frac{\partial h}{\partial s}\right _P$
		(N7)	$-\left.\frac{\partial h}{\partial P}\right _s$
		(N8)	$\left.\frac{\partial h}{\partial s}\right _P$

- (A) M1-N5, M2-N1, M3-N4, M4-N7
- (B) M1-N6, M2-N2, M3-N3, M4-N8
- (C) M1-N5, M2-N1, M3-N4, M4-N8
- (D) M1-N8, M2-N1, M3-N4, M4-N5

Q.100 10 kg of water at 300 K is poured into a bucket containing 10 kg of water at 350 K. Heat capacity of water is 4.2 kJ/kg.K . Neglecting any heat losses to the surroundings, the change in the entropy (in kJ/K) of the system during this process (*rounded off to two decimal places*) is

- (A) 0.00
- (B) 0.25
- (C) 0.50
- (D) 0.75

Q.101 A Carnot engine operates between two temperatures T_1 and T_2 such that $T_1 > T_2$. If the thermal efficiency of the engine is to be increased by changing one of the temperatures by a constant amount $\Delta T > 0$, which one of the following cases will give the highest increase in efficiency?

- (A) Increasing T_1 by ΔT while keeping T_2 constant
- (B) Decreasing T_1 by ΔT while keeping T_2 constant
- (C) Increasing T_2 by ΔT while keeping T_1 constant
- (D) Decreasing T_2 by ΔT while keeping T_1 constant

Q.102 The equation of state for a non-ideal gas is

$$\frac{Pv}{RT} = 1 + BP$$

where P is pressure, v is specific volume, R is the specific gas constant, T is temperature, and B is a temperature dependent parameter. For this gas, the partial derivative of enthalpy with respect to pressure at constant temperature is

(A) BRT

(B) $-RT^2 \left(\frac{dB}{dT} \right)$

(C) $BRT - RT^2 \left(\frac{dB}{dT} \right)$

(D) 0

Q.103 Consider the following data from a Brayton cycle.

Enthalpy at inlet to turbine: 1400 kJ/kg

Enthalpy at exit of turbine: 880 kJ/kg

Enthalpy at exit of compressor: 600 kJ/kg

On adding a regenerator of effectiveness equal to 0.8, the absolute value of percentage change in heat addition is _____ (rounded off to the nearest integer).

Q.104 An ideal gas undergoes a series of reversible steady state, steady flow processes between states 1, 2, and 3. Process 1→2 satisfies the relation $P + 800v = 900$, where pressure, P is in kPa and specific volume, v is in m^3/kg . Process 2→3 is isochoric. Given that $v_1 = 0.5 \text{ m}^3/\text{kg}$, $v_2 = v_3 = 1 \text{ m}^3/\text{kg}$, $\frac{P_3}{P_2} = 4$, the total work done per unit mass (in kJ/kg) in the series of processes 1→2→3 is _____ (rounded off to the nearest integer).

Q.105 Air (assumed as an ideal gas) with a mass flow rate of 2.5 kg/s enters a horizontal nozzle at 350 K, 350 kPa with a velocity of 3 m/s. The air exits the nozzle at a pressure of 101.5 kPa and temperature 305 K with a Mach number of $\frac{9}{7}$. Assuming steady state operation and constant properties given in the data, the ratio of inlet area to exit area required to satisfy the exit condition is _____ (rounded off to one decimal place).

Use the following data: $\gamma = 1.4$, $c_p = 1.011 \text{ kJ/kg.K}$, $R = 0.287 \text{ kJ/kg.K}$

Q.106 The melting point of a substance at 1 bar is 273 K. The following property data is available for this substance at 1 bar.

Density of the solid phase	900 kg/m^3
Density of the liquid phase	1000 kg/m^3
Latent heat for melting	300 kJ/kg

Assuming that the above properties are constant, the melting point (in K) of the substance at 101 bar is _____ (rounded off to two decimal places).

- Q.107 100 moles of moist air at 70% relative humidity is cooled from 70 °C to 50 °C at a constant pressure of 1 bar. The vapour pressures of water are given in the table. The number of moles of water left in the moist air at the end of this process is _____ (rounded off to two decimal places).

Temperature (°C)	Vapour Pressure (kPa)
50	12.34
70	31.16

- Q.108 A rigid insulated tank containing an ideal gas at 300 K and 1 bar is being filled from an external pressurized line supplying the same gas at 300 K and 10 bar. When the mass of gas inside the tank has doubled, its temperature (in K) is _____ (rounded off to the nearest integer).

Assume ratio of specific heats to be constant for this process and equal to 1.4.

- Q.109 A piston-cylinder system contains 2 kg of wet steam at 90 °C with quality of 0.1 . The piston is loaded with a linear spring. The steam expands to 800 kPa and 250 °C on heating. The work done (in kJ) in this process is _____ (rounded off to two decimal places).

Use the following data:

$$\text{At } 90 \text{ }^\circ\text{C: } P_{sat} = 70 \text{ kPa, } v_f = 0.001 \text{ m}^3/\text{kg, } v_g = 2.4 \text{ m}^3/\text{kg}$$

$$\text{At } 250 \text{ }^\circ\text{C and } 800 \text{ kPa: } v = 0.29 \text{ m}^3/\text{kg}$$

Polymer Science and Engineering (XE – F)

Q.110– Q.118 Carry ONE mark Each

Q.110 Phenol-formaldehyde resin is prepared by

- (A) condensation polymerization
- (B) cationic polymerization
- (C) anionic polymerization
- (D) ring opening polymerization

Q.111 Melting phenomenon in a semi-crystalline polymer is a _____ order phase transition.

- (A) zeroth
- (B) first
- (C) second
- (D) third

Q.112 A certain polymer synthesized in the laboratory shows that all the chains have same number of repeat units (*i.e.*, same degree of polymerization). The relationship between weight-average (\bar{M}_w), number-average (\bar{M}_n), and z-average (\bar{M}_z) molecular weights for this polymer can be expressed as

(A) $\bar{M}_z > \bar{M}_w > \bar{M}_n$

(B) $\bar{M}_z = \bar{M}_w = \bar{M}_n$

(C) $\bar{M}_z < \bar{M}_w < \bar{M}_n$

(D) $\bar{M}_z > \bar{M}_w < \bar{M}_n$

Q.113 Nitrile rubber is the copolymer of

(A) styrene and butadiene

(B) styrene and isoprene

(C) styrene and acrylonitrile

(D) butadiene and acrylonitrile

Q.114 A suitable physical compatibilizer of a binary blend of poly(ethylene) and poly(propylene) is _____.

- (A) poly(caprolactam)
- (B) poly(lactic acid)
- (C) poly(ethylene-*block*-propylene)
- (D) poly(carbonate)

Q.115 The 'die swell' phenomenon exhibited by a polymer melt is due to

- (A) viscous deformation
- (B) plastic deformation
- (C) viscous and elastic deformation
- (D) elastic recovery

Q.116 Thermoforming operation of semi-crystalline polymers with glass transition temperature, T_g , and melting temperature, T_m , is carried out at a temperature T , in the range of

- (A) $T_g < T < T_m$
- (B) $T_g < T > T_m$
- (C) $T_g > T = T_m$
- (D) $T_g > T > T_m$

Q.117 Feedstock recycling of poly(ethylene terephthalate) is carried out by

- (A) hydrogenation
- (B) dehydrogenation
- (C) hydrolysis
- (D) ozonation

Q.118 Which of the following polymers is/are synthesized by ring opening polymerization?

- (A) Poly(lactic acid)
- (B) Poly(ϵ -caprolactone)
- (C) Poly(styrene)
- (D) Poly(aniline)

Q.119 – Q.131 Carry TWO marks Each

Q.119 The propagation step of a free radical copolymerization is represented by the following possible reaction steps:

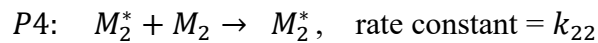
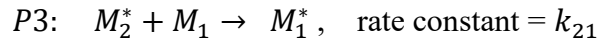
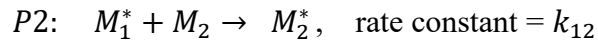
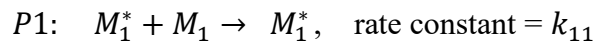

where, M_1 and M_2 are two monomers and M_1^* and M_2^* are the active radicals of M_1 and M_2 , respectively. k_{ij} ($i, j = 1, 2$) represents the rate constant of each step as shown above.

If the reactivity ratios of M_1 and M_2 are expressed as: $r_1 = k_{11}/k_{12}$ and $r_2 = k_{22}/k_{21}$, respectively, and feed mole ratio, F is expressed as $F = [M_1]/[M_2]$ (where, $[M_1]$ and $[M_2]$ are the concentrations of M_1 and M_2 , respectively), the probability of the reaction P2 is _____.

(A) $\frac{r_1}{r_1 F + 1}$

(B) $\frac{1}{r_1 F + 1}$

(C) $\frac{1}{r_2 + F}$

(D) $\frac{r_2}{F + r_2}$

Q.120 Match the following additives to their respective functions for poly(vinyl chloride) compounding.

Additive	Function
P. Dibutyltin maleate	1. Lubricant
Q. Epoxydized soybean oil	2. Extender
R. Chlorinated paraffin wax	3. Heat stabilizer
S. Calcium stearate	4. Plasticizer

- (A) P-3; Q-4; R-2; S-1
- (B) P-2; Q-4; R-1; S-3
- (C) P-3; Q-2; R-1; S-4
- (D) P-4; Q-2; R-1; S-3

Q.121 Match the following properties with their respective units.

Property	Unit
P. Notched Izod impact strength	1. Pa s
Q. Flexural strength	2. J m ⁻¹
R. Dielectric strength	3. MPa
S. Complex viscosity	4. kV cm ⁻¹

- (A) P-1; Q-2; R-3; S-4
- (B) P-2; Q-1; R-3; S-4
- (C) P-2; Q-3; R-4; S-1
- (D) P-3; Q-1; R-2; S-4

Q.122 Melt flow index (MFI) of a polymer depends on its molecular weight (MW) and melt viscosity (η). Select the correct relation(s) from the following.

(A) $MFI \propto \frac{1}{MW}$

(B) $MFI \propto MW$

(C) $MFI \propto \frac{1}{\eta}$

(D) $MFI \propto \eta$

Q.123 Biaxially oriented poly(propylene) exhibits high clarity because layering of the crystalline structures

(A) decreases the variation in refractive index across the film thickness

(B) decreases the amount of light scattering

(C) increases the variation in refractive index across the film thickness

(D) increases the amount of light scattering

- Q.124 If a given poly(ethylene) sample with specific volume, $v = 1.042 \times 10^{-3} \text{ m}^3 \text{ kg}^{-1}$ shows:
specific volume of the crystalline fraction, $v_c = 0.989 \times 10^{-3} \text{ m}^3 \text{ kg}^{-1}$ and
specific volume of the amorphous fraction, $v_a = 1.160 \times 10^{-3} \text{ m}^3 \text{ kg}^{-1}$,
then the % crystallinity (based on mass fraction) of the poly(ethylene) sample is _____ % (rounded off to the nearest integer).
- Q.125 The glass transition temperature (T_g) of poly(2,6-dimethyl-*p*-phenylene oxide) (PPO) is 206.8 °C and the T_g of poly(styrene) (PS) is 90 °C. The T_g of a 50/50 (wt/wt) miscible blend of PPO/PS is _____ °C (rounded off to the nearest integer).
- Q.126 A unidirectional composite is prepared using 70% by volume of epoxy matrix and 30% by volume of carbon fibre. The elastic modulus of the epoxy matrix is 3.5 GPa and the elastic modulus of the carbon fibre is 350 GPa. The longitudinal elastic modulus of the composite is _____ GPa (rounded off to the nearest integer).
- Q.127 Polyamide 66 is prepared by the condensation polymerization of 0.08 mol of hexamethylenediamine with 0.08 mol of adipic acid. At the end of the polymerization reaction, the reaction product contained 0.002 mol of unreacted carboxylic acid groups. The molecular weight of the repeat unit of polyamide 66 is 226 g mol⁻¹. The number-average molecular weight (\bar{M}_n) of the polyamide 66 in the reaction product is _____ g mol⁻¹ (rounded off to the nearest integer).

Q.128 A monodisperse polymer sample of molecular weight $10,000 \text{ g mol}^{-1}$ is mixed with another monodisperse sample of the same polymer of molecular weight $50,000 \text{ g mol}^{-1}$. The total mass of the mixture is $1,000 \text{ g}$ and the total number of moles of the polymer in the mixture is 0.04 mol . The weight-average molecular weight (\bar{M}_w) of the polymer mixture is _____ g mol^{-1} (rounded off to the nearest integer).

Q.129 For a polymer solution, the dependence of viscosity (η) on shear rate ($\dot{\gamma}$) is described by the three-parameter Carreau model given by

$$\eta = \eta_0 [1 + (\lambda \dot{\gamma})^2]^{(n-1)/2}$$

where, η_0 , λ , and n are the three parameters of the model. Here, all three parameters are positive quantities. As the shear rate increases from 1 s^{-1} to 100 s^{-1} , the viscosity of the polymer solution decreases by a factor of 10. For a polymer solution with $n = 0.4$ and $\eta_0 = 15 \text{ Pa s}$, the value of the parameter λ is _____ s (rounded off to two decimal places).

- Q.130 The dilute solution viscometry data for two samples of a polymer with two different molecular weights are shown in the figure, where η_{sp}/c has been plotted against c . Here, η_{sp} is the specific viscosity and c is the mass concentration of the polymer solution. The slopes and intercepts of the plots for both the samples are shown in the figure. The plotted data for both samples are described by the Huggins equation of dilute solution. The value of the Mark-Houwink constant 'a' for both polymer samples is 0.5.

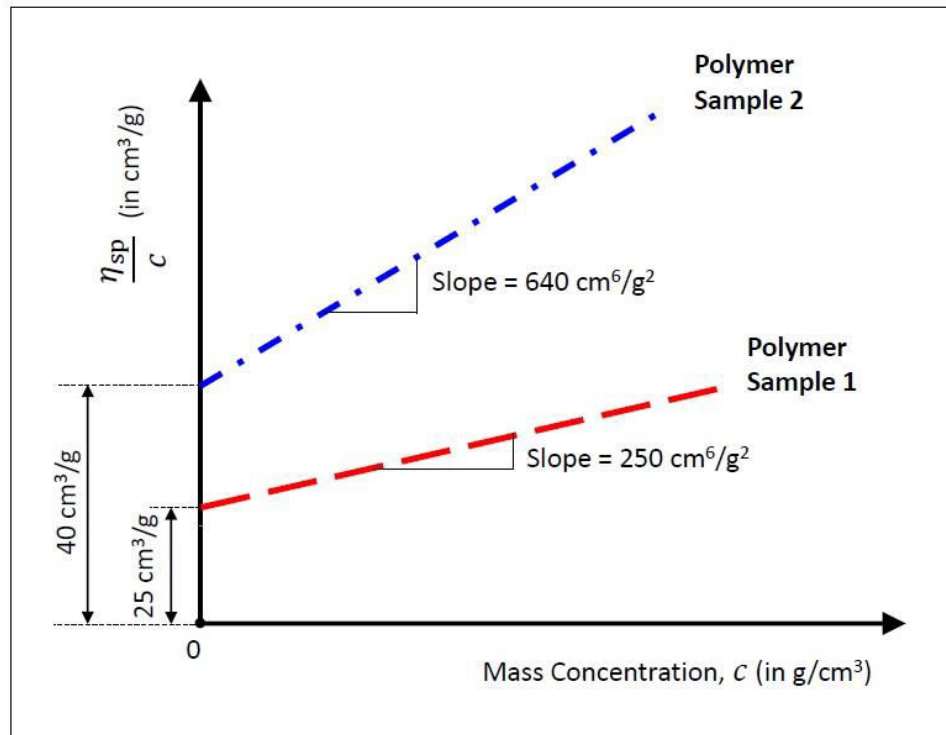

The ratio of the viscosity-average molecular weight (\bar{M}_v) of polymer sample 1 to that of polymer sample 2, i.e., $(\bar{M}_v)_1/(\bar{M}_v)_2$, is _____ (rounded off to two decimal places).

- Q.131 The linear viscoelastic behaviour of a polymer is described by the Kelvin-Voigt model consisting of a spring element of elastic modulus 10 MPa in parallel with a dashpot of viscosity 3.6×10^{11} Pa s. A fixed stress of 40 MPa is suddenly applied to the polymer and maintained thereafter. The value of the strain after one hour from the sudden application of the stress is _____ (rounded off to two decimal places).

Food Technology (XE-G)

Q.132– Q.140 Carry ONE mark Each

Q.132 Which one of the following fungi produces aflatoxins?

- (A) *Aspergillus niger*
- (B) *Fusarium verticillioides*
- (C) *Aspergillus flavus*
- (D) *Rhizopus oligosporus*

Q.133 Under standard conditions in animal feeding studies, the weight gained (in grams) per gram of protein consumed by an animal is termed as

- (A) Net Protein Ratio
- (B) Net Protein Utilization
- (C) Coefficient of Protein Digestibility
- (D) Protein Efficiency Ratio

Q.134 Xerophthalmia is caused due to the deficiency of

- (A) Thiamin
- (B) Pantothenic acid
- (C) Vitamin A
- (D) Vitamin C

Q.135 Which one of the following steps is used to remove phosphatides from crude oil in the refining process?

- (A) Neutralization
- (B) Bleaching
- (C) Degumming
- (D) Deodorization

Q.136 The unique flavor of chocolate and cocoa is due to the formation of

- (A) 5-methyl-2-phenyl-2-hexenal
- (B) Cyclotene
- (C) Furaneol
- (D) Maltol

Q.137 Which one of the following statements regarding Hazard Analysis Critical Control Point (HACCP) plan is **NOT** correct?

- (A) HACCP is a management tool for ensuring food safety.
- (B) HACCP involves five preliminary steps and seven principles.
- (C) HACCP is not effective without prior implementation of prerequisite programs.
- (D) HACCP plan involves establishment of corrective actions as second principle.

Q.138 The product of cabbage fermentation by *Leuconostoc mesenteroides* is

- (A) Tempeh
- (B) Natto
- (C) Sauerkraut
- (D) Miso

Q.139 Which one of the following absorbents is **NOT** used as an ethylene absorber in active packaging of fruits and vegetables?

- (A) Potassium permanganate
- (B) Activated carbon
- (C) Calcium hydroxide
- (D) Silica gel

Q.140 Thermal resistance constant (z-value) is defined as the change in temperature required to reduce the decimal reduction time of a microorganism by _____ percent (*Answer in integer*).

Q.141 – Q.153 Carry TWO marks Each

Q.141 Which one of the following statements regarding moisture sorption isotherms of a dried food is **NOT** correct?

- (A) At a given temperature, the difference between adsorption and desorption moisture isotherms is known as hysteresis.
- (B) At a given temperature and water activity, an adsorption isotherm exhibits higher equilibrium moisture content than a desorption isotherm in hysteresis.
- (C) At a given moisture content, effect of temperature on a moisture sorption isotherm follows the Clausius- Clapeyron equation.
- (D) The Guggenheim-Anderson-de Boer (GAB) equation is a multilayer moisture sorption model.

Q.142 Processing of fluid milk at 72 °C for 15 seconds is termed as

- (A) High-temperature, short-time (HTST) pasteurization
- (B) Low-temperature, long-time (LTLT) pasteurization
- (C) Ultra high-temperature (UHT) pasteurization
- (D) Homogenization process

Q.143 Match the anti-nutritional factor in **Column I** with their corresponding activity given in **Column II**.

Column I

Column II

P. Lectin

1. Flatulence

Q. Stachyose

2. Chelates with divalent cations and reduces their bio-availability

R. Phytate

3. Inhibits trypsin and chymotrypsin

S. Knuitz type inhibitor

4. Hemagglutination

(A) P-4,Q-1, R-2,S-3

(B) P-3,Q-1, R-2,S-4

(C) P-2,Q-1, R-4,S-3

(D) P-1,Q-2, R-3,S-4

Q.144 Which of the following fatty acids is/are known to increase the low density lipoprotein (LDL)-cholesterol?

(A) Omega-3 Fatty acids

(B) Trans Fatty acids

(C) Conjugated Linoleic acids

(D) Saturated Fatty acids

Q.145 The addition of which of the following to high-methoxyl pectin will result in gel formation?

- (A) Calcium ions
- (B) Hydrogen ions
- (C) Sodium ions
- (D) Sugar

Q.146 Which of the following steps in food processing is/are used to reduce the acrylamide formation in food products?

- (A) Pretreatment using asparaginase
- (B) Lowering the pH
- (C) Increasing the temperature.
- (D) Adding glucose.

Q.147 Which of the following enzymes is/are used for the production of high fructose syrup (HFS) from corn starch?

- (A) α -Amylase
- (B) β -Amylase
- (C) Xylose isomerase
- (D) Glucoamylase

Q.148 Which of the following is/are typical characteristic(s) of a fungal cell?

- (A) Presence of histone proteins
- (B) Presence of peptidoglycans in the cell wall
- (C) Presence of chitin in the cell wall
- (D) Presence of pseudomurein in the cell wall

Q.149 Which of the following statements is/ are correct regarding food and water borne disease and the class of causative microorganisms?

- (A) Legionellosis is a bacterial disease.
- (B) Giardiasis is caused by the protists.
- (C) Typhoid fever is caused by the virus.
- (D) Listeriosis is a fungal disease.

Q.150 Which of the following statements is/ are true?

- (A) Hagen-Poiseuille's law is used for calculation of molecular diffusion.
- (B) Fick's law is used for calculation of energy requirement in size reduction.
- (C) Rittinger's law is used for calculation of energy requirement in size reduction.
- (D) Stokes law is used for derivation of terminal velocity.

- Q.151 A 10 kg tomato pulp is concentrated from an initial moisture content of 90% (wet weight basis) to 35% (wet weight basis). The weight of the concentrate in kg is _____ (round off to 2 decimal places).
- Q.152 The surface temperature of a hot plate is 175 °C. The ambient air temperature is 25 °C. The rate of heat transfer per unit area in kW.m⁻² from the plate to the ambient air is _____ (Answer in integer). Assume the convective heat transfer coefficient is 20 W.m⁻².K⁻¹.
- Q.153 A tubular bowl centrifuge is used to separate an aqueous phase from an oil phase. The radii of outlets of the light and heavy liquids are set at 4.5 cm and 4.6 cm, respectively. The radius in cm of the neutral zone in the centrifuge is _____ (round off to 2 decimal places). Assume the density of the aqueous phase is 950 kg.m⁻³ and that of oil is 900 kg.m⁻³.

Atmospheric and Ocean Science (XE - H)

Q.154– Q.162 Carry ONE mark Each

Q.154 A westerly wind is blowing in the Northern Hemisphere. What is the direction of net mass transport in the Ekman layer?

- (A) Southward
- (B) Northward
- (C) North-Eastward
- (D) South-Westward

Q.155 Which one of the following feature is NOT necessary for the formation of Indian summer monsoon?

- (A) Land-sea temperature contrast
- (B) El Niño
- (C) Seasonal reversal of winds
- (D) Meridional pressure gradient

Q.156 The work done by Coriolis force is

- (A) directly proportional to velocity
- (B) a function of latitude
- (C) zero
- (D) always positive except at the equator

Q.157 If the isobars and isopycnals are parallel to each other, the flow is said to be

- (A) baroclinic
- (B) barotropic
- (C) geostrophic
- (D) rotational

Q.158 Transfer of energy between ocean and atmosphere in the form of sensible heat flux is due to

- (A) difference in specific humidity between ocean and atmosphere
- (B) difference in temperature between upper surface of the ocean and lower part of the atmosphere
- (C) difference in density between upper surface of the ocean and lower part of the atmosphere
- (D) difference in partial pressure of CO₂ between ocean and atmosphere

Q.159 A value of outgoing long-wave radiation (OLR) $< 200 \text{ W m}^{-2}$ over the tropical oceans indicates _____.

- (A) high pressure region
- (B) deep convection
- (C) high sea surface temperature
- (D) clear sky condition

Q.160 Which of the following is a correct statement?

- (A) Tropics receive more incoming short-wave radiation than the outgoing long-wave radiation.
- (B) Polar regions do not emit any long-wave radiation.
- (C) Both tropics and polar regions receive and emit equal amounts of radiation.
- (D) Polar regions receive more short-wave radiation than tropics.

Q.161 Upwelling region has _____ .

- (A) low sea surface height
- (B) high sea surface height
- (C) decrease in primary production
- (D) low nutrients

Q.162 Density of sea-water does not directly depend on _____ .

- (A) temperature of sea water
- (B) salinity of sea water
- (C) pressure of sea water
- (D) vorticity of sea water

GATE 2024

Q.163 – Q.175 Carry TWO marks Each

Q.163 Which of the following is/are true about ocean circulation?

- (A) Wind driven circulation, with constant Coriolis force, can produce narrow and fast western boundary currents.
- (B) Wind driven circulation, with Coriolis force varying with latitude, can produce narrow and fast western boundary currents.
- (C) The eastern boundary currents of subtropical gyres are wide and slow.
- (D) Wind driven circulation leads to Ekman transport.

Q.164 Svedrup's equation deals with:

- (A) curl of wind stress
- (B) pressure gradient force
- (C) variation of Coriolis force with latitude
- (D) meridional transport of sea water

Q.165 pH of the water in the oceans is/are directly affected by:

- (A) water temperature
- (B) water salinity
- (C) total alkalinity
- (D) water pressure

Q.166 Billow clouds indicate:

- (A) turbulence in the atmosphere
- (B) vertical shear of the wind
- (C) heavy precipitation
- (D) uniform winds

Q.167 Consider an atmospheric flow at 45°N , which is parallel to latitude and isobars. Which of the following is/are true when there is no friction?

- (A) Flow is in gradient wind balance.
- (B) Acceleration of the flow is close to zero.
- (C) The above description depicts an extratropical cyclone.
- (D) A balance between Coriolis force and pressure gradient force.

GATE 2024

Q.168 The given figure shows a schematic of dry, moist, and environmental lapse rates. Which of the following is/are correct statements?

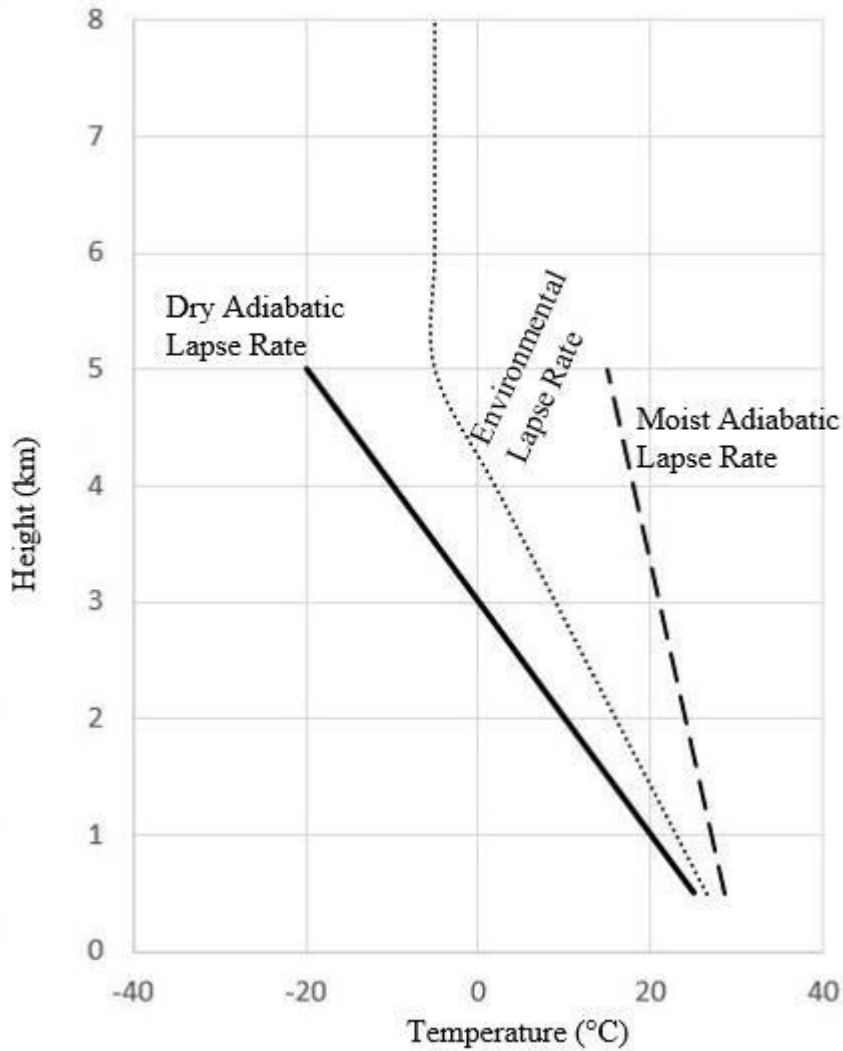

- (A) The lapse rate of environment below 5 km is $-15 \text{ }^\circ\text{C km}^{-1}$
- (B) The atmosphere is unstable above 5 km
- (C) The chances of a deep convective cloud growth above 5 km are less
- (D) The atmosphere is conditionally unstable below 5 km

Q.169 Balance of forces and different types of flows/weather phenomena in the northern hemisphere are given. Match the following:

Balance of forces		Flow type/weather phenomena	
P	Balance between pressure gradient force, centrifugal force and Coriolis force in anticlockwise rotation	X	Geostrophic flow
Q	Balance between pressure gradient force and centrifugal force in clockwise/anticlockwise rotation	Y	Cyclones
R	Balance between pressure gradient force and Coriolis force in a uniform flow	Z	Tornado

- (A) P - Z; Q - X; R - Y
- (B) P - X; Q - Y; R - Z
- (C) P - Y; Q - Z; R - X
- (D) P - Y; Q - X; R - Z

Q.170 During summer monsoon season, water from Arabian Sea spreads over the south-western Bay of Bengal. This leads to

- (A) formation of salt fingers
- (B) upwelling
- (C) western boundary current
- (D) downwelling

Q.171 Net solar radiation of 1360 W m^{-2} is incident on the surface of a still lake having mixed layer depth of 20 m. Find the change in temperature (in SI units) of the mixed layer of the lake for a day length of 8 hours. (Rounded off to 2 decimal places)

Assume that there is no variation in solar radiation in a day and all radiation incident on the surface is absorbed uniformly throughout the mixed layer (Density of lake water is 1025 kg m^{-3} and Specific heat capacity (C_p) of lake water is $3850 \text{ J kg}^{-1} \text{ K}^{-1}$).

Q.172 A homogeneous, incompressible, steady ocean of mixed layer depth of 20 m has a velocity gradient $-5 \times 10^{-8} \text{ s}^{-1}$ and $-8.3 \times 10^{-8} \text{ s}^{-1}$ along zonal and meridional directions, respectively. The vertical mass flux (in kg s^{-1}) at the base of the mixed layer of $100 \text{ km} \times 100 \text{ km}$ area is _____ $\times 10^6 \text{ kg s}^{-1}$ (Density of sea water is 1025 kg m^{-3}). (Rounded off to 1 decimal place)

Q.173 Wind blows over the ocean surface at a speed of 10 m s^{-1} . Calculate the magnitude of wind stress, in Pa, using bulk formulation. (Drag coefficient is 1.4×10^{-3} and density of air is 1.3 kg m^{-3}) (Rounded off to 3 decimal places)

- Q.174 Two stations 'A' and 'B', present at a latitude of 30°N are separated by a distance of 10 km. If the difference in sea surface height between these two stations is 1 m, what will be the magnitude of geostrophic current velocity in SI units? (Assume the angular velocity of earth is 10^{-4} s^{-1}) (*Answer in integer*)
- Q.175 A stationary air parcel centered on the equator is moved north-ward by conserving absolute vorticity. In the new location it has gained a relative vorticity of -10^{-4} s^{-1} . The latitude of its new location is _____ $^\circ\text{N}$. (Assume the angular velocity of earth is 10^{-4} s^{-1}). (*Answer in integer*)

GATE 2024